



**VACON CX / CXL / CXS
FREQUENCY CONVERTERS**

***Multi-purpose Control
Application II***

USER'S MANUAL

Subject to changes without notice

Multi-purpose Control Application II

(par. 0.1 = 0)

CONTENTS

1 General	2
2 Control I/O	2
3 Control signal logic	3
4 Parameter Group 0	4
5 Parameters Group 1	5
5.1 Parameter table	5
5.2 Description of Group1 par.	6
6 Special parameters, Groups 2-11	10
6.1 Parameter tables	10
6.2 Description of Group 2 par.	19
7 Fault code	46
8 Monitoring data	46

Software ID: smf089xx

1 General

Multi-purpose II application is an extender version of the normal Multipurpose application. It has parameters for torque control and, furthermore, for Fieldbus communication. Following fieldbuses are supported: Interbus, Modbus, Profibus, LonWorks, CAN-bus (SDS, DeviceNet).

Frequency reference, analogue and digital outputs have extra alternatives in their control parameters. Source of free analogue input can now be selected from the I/O Expander. These inputs have also parameters for signal area etc. programming.

2 Control I/O

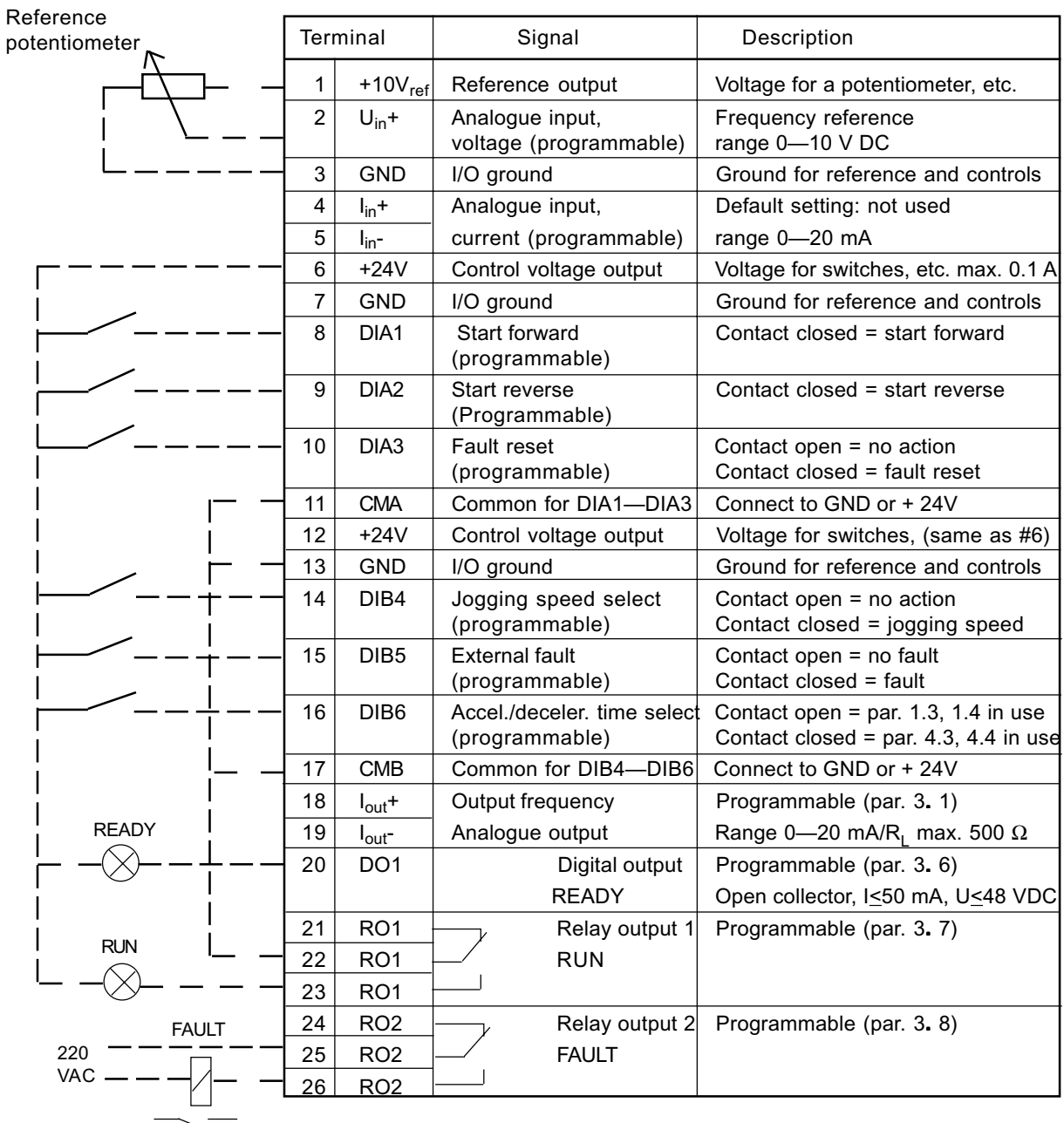

Figure 2-1 Default I/O configuration and connection example of the Multi-purpose Control Application.

3 Control signal logic

In figure 3-1 the logic of I/O-control signals and push button signals from the panel are presented.

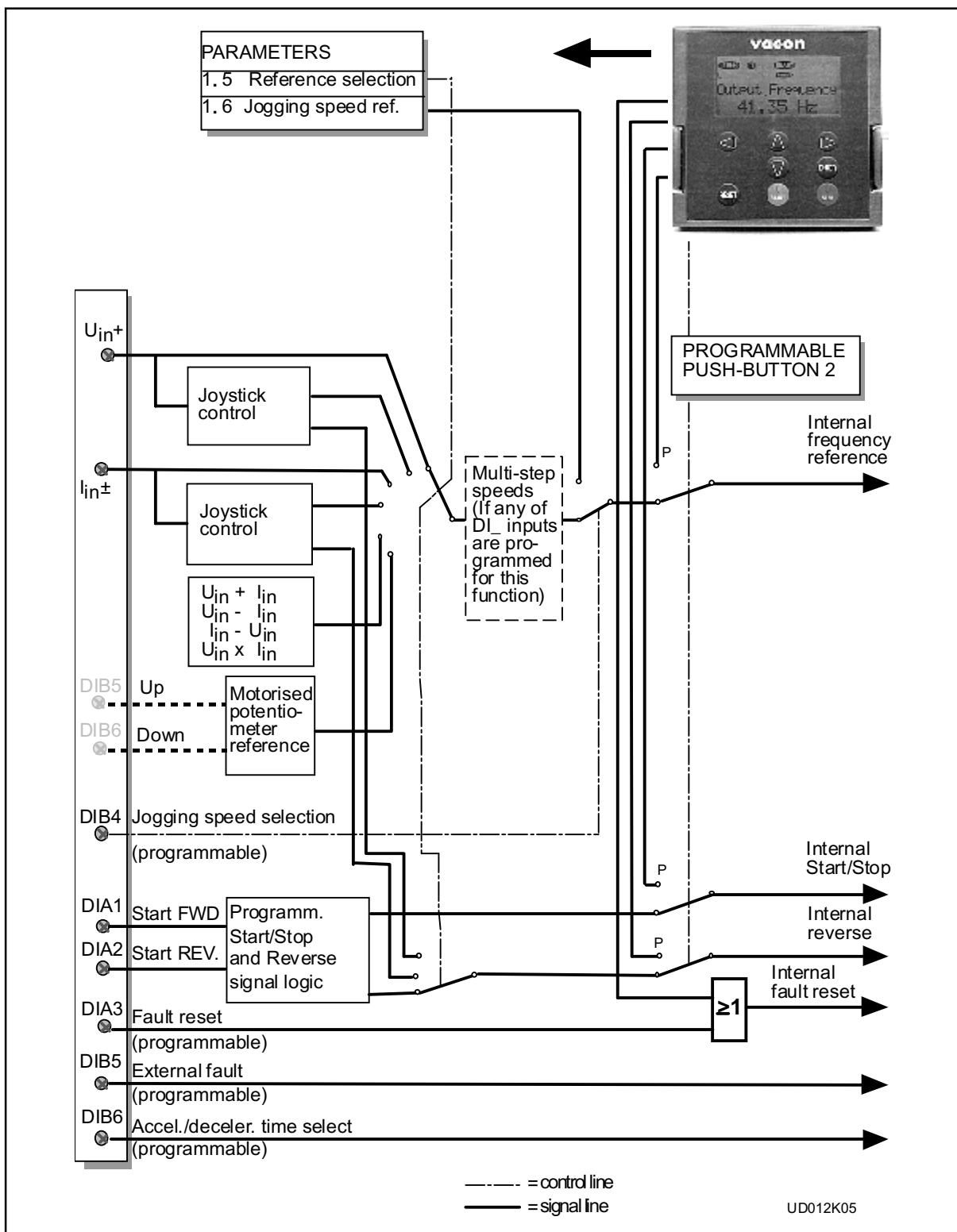

Figure 3-1 Control signal logic of the Multipurpose II Application. Switch positions correspond to factory settings.

4 Parameter group 0

Number	Parameter	Range	Step	Default	Customer	Description
0.1	Application selection	0-7	1	0		0 = Multipurpose II (loaded special application) 1 = Basic Application 2 = Standard Application 3 = Local/Remote Control Application 4 = Multi-step Speed Application 5 = PI-control Application 6 = Multi-purpose Control Application 7 = Pump and Fan Control Application
0.2	Parameter loading	0-5	1	0		0 = Loading ready / Select loading 1 = Load default setting 2 = Read up parameters to user's set 3 = Load down user's set parameters 4 = Read parameters up to the panel (possible only with graphical panel) 5 = Load down parameters from panel (possible only with graphical panel)
0.3	Language selection	0-2	1	0		0 = English 1 = Germany 2 = Finnish

Table 4-1 Parameter group 0.

0.1 Application selection

With this parameter the active application can be selected. If the device has been ordered from the factory equipped with Multipurpose II application this has been loaded to the unit as application 0. The application has also been set active at the factory. However, check that the value of the parameter 0.1 is zero when you want to use Multipurpose II.

If the application should be loaded to the device later it has to be set active always after loading by setting the value of parameter 0.1 to zero.

0.2 Parameter loading

See User's Manual chapter 11.

0.3 Language

With this parameter, the language of the graphical panel can be selected.

5 Basic Parameters, Group 1

5.1 Parameter table

Code	Parameter	Range	Step	Default	Custom	Description	Page
1.1	Minimum frequency	0—120/500 Hz	1 Hz	0 Hz			6
1.2	Maximum frequency	0—120/500 Hz	1 Hz	50 Hz	*)		6
1.3	Acceleration time 1	0.1—3000 s	0.1 s	3 s		Time from f_{min} (1.1) to f_{max} (1.2)	6
1.4	Deceleration time 1	0.1—3000 s	0.1 s	3 s		Time from f_{max} (1.2) to f_{min} (1.1)	6
1.5	Reference selection	0—15	1	0		0 = U_{in} 1 = I_{in} 2 = $U_{in} + I_{in}$ 3 = $U_{in} - I_{in}$ 4 = $I_{in} - U_{in}$ 5 = $U_{in} * I_{in}$ 6 = U_{in} joystick control 7 = I_{in} joystick control 8 = Signal from internal motor pot. 9 = Signal from internal motor pot. reset if Vacon unit is stopped 10 = Signal from internal motor pot. (stored in memory over mains break) 11 = Min (U_{in}, I_{in}) 12 = Max (U_{in}, I_{in}) 13 = Panel reference r1 14 = Max reference 15 = U_{in}/I_{in} selection	6
1.6	Jogging speed reference	$f_{min} - f_{max}$ (1.1) (1.2)	0.1 Hz	5 Hz			7
1.7	Current limit	0.1—2.5 x I_{ncx}	0.1 A	1.5 x I_{cex}		Output current limit [A] of the unit	7
1.8	U/f ratio selection	0—2	1	0		0 = Linear 1 = Squared 2 = Programmable U/f ratio	7
1.9	U/f optimisation	0—1	1	0		0 = None 1 = Automatic torque boost	8
1.10	Nominal voltage of the motor	180—690	1 V	230 V 400 V 500 V 690 V		Vacon range CX/CXL2 Vacon range CX/CXL/CXS4 Vacon range CX/CXL/CXS5 Vacon range CX6	9
1.11	Nominal frequency of the motor	30—500 Hz	1 Hz	50 Hz		f_n on the rating plate of the motor	9
1.12	Nominal speed of the motor	300—20000 rpm	1 rpm	1440 rpm		n_n on the rating plate of the motor	9
1.13	Nominal current of the motor	2.5 x I_{ncx}	0.1 A	I_{ncx}		I_n on the rating plate of the motor	9
1.14	Supply voltage	180—250		230 V		Vacon range CX/CXL2	9
		380—440		400 V		Vacon range CX/CXL/CXS4	
		380—500		500 V		Vacon range CX/CXL/CXS5	
		525—690		690 V		Vacon range CX6	
1.15	Parameter conceal	0—1	1	0		0 = All parameter groups visible 1 = Only group 1 visible	9
1.16	Parameter value lock	0—1	1	0		0 = Parameter changes enabled 1 = parameter changes disabled	9

Table 5-1. Group 1 basic parameters

*) If 1, 2 > motor synchr. speed, check suitability for motor and drive system.

Note!  = Parameter value can be changed only when the frequency converter is stopped. (Continues)

5.2 Description of Group 1 parameters

1. 1, 1. 2 Minimum / maximum frequency

Defines frequency limits of the frequency converter.

The default maximum value for parameters 1. 1 and 1. 2 is 120 Hz. By setting 1. 2 = 120 Hz when the device is stopped (RUN indicator not lit) parameters 1. 1 and 1. 2 are changed to 500 Hz. At the same time the panel reference resolution is changed from 0.01 Hz to 0.1 Hz.

Changing the max. value from 500 Hz to 120 Hz is done by setting the parameter 1. 2 = 119 Hz when the device is stopped.

1. 3, 1. 4 Acceleration time 1, deceleration time 1:

These limits correspond to the time required for the output frequency to accelerate from the set minimum frequency (par. 1. 1) to the set maximum frequency (par. 1. 2).

1. 5 Reference selection

0 Analogue voltage reference from terminals 2—3, e.g. a potentiometer

1 Analogue current reference from terminals 4—5, e.g. a transducer.

2 Reference is formed by adding the values of the analogue inputs

3 Reference is formed by subtracting the voltage input (U_{in}) value from the current input (I_{in}) value.

4 Reference is formed by subtracting the current input (I_{in}) value from the voltage input (U_{in}) value.

5 Reference is the formed by multiplying the values of the analogue inputs

6 Joystick control from the voltage input (U_{in}).

Signal range	Max reverse speed	Direction change	Max forward speed
0—10 V	0 V	5 V	+10 V
Custom	Par. 2.7 x 10 V	In the middle of custom range	Par. 2.8 x 10 V
-10 V—+ 10 V	-10 V	0 V	+10 V

Warning!



Use only -10V—+10 V signal range. If a custom or 0—10 V signal range is used, the drive starts to run at the max. reverse speed if the reference signal is lost.

7 Joystick control from the current input (I_{in}).

Signal range	Max reverse speed	Direction change	Max forward speed
0—20 mA	0 mA	10 mA	20 mA
Custom	Par. 2. 13 x 20 mA	In the middle of custom range	Par. 2. 14 x 20 mA
4—20 mA	4 mA	12 mA	20 mA

Warning!



Use only 4—20 mA signal range. If custom or 0—20 mA signal range is used, the drive runs at max. reverse speed if the control signal is lost. Set the reference fault (par. 7. 2) active when the 4—20 mA range is used, then the drive will stop to the reference fault if the reference signal is lost.

Note! When joystick control is used, the direction control is generated from joystick reference signal. See figure 5.4-1. Analogue input scaling, parameters 2. 16—2. 19 are not used when joystick control is used.

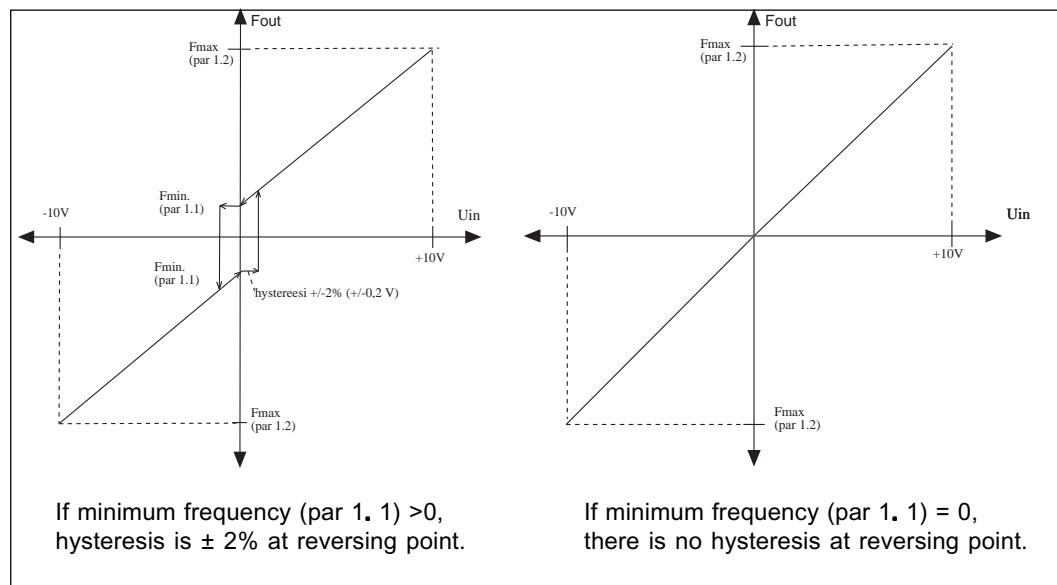

Fig. 5-1 Joystick control U_{in} signal -10 V—+10 V.

- 8** Reference value is changed with digital input signals DIB5 and DIB6.
 - switch in DIB5 closed = frequency reference increases
 - switch in DIB6 closed = frequency reference decreases
 Speed of reference change can be set with the parameter 2. 20.
- 9** Same as setting 8 but the reference value is set to the minimum frequency (par. 1. 1) each time the frequency converter is stopped.
- 10** Same as setting 8 but the reference is stored to the memory over mains break. When the value of the parameter 1. 5 is set to 8, 9 or 10, the values of the parameters 2. 4 and 2. 5 are automatically set to 11.
- 11** The minor of signals U_{in} and I_{in} is the frequency reference
- 12** The greater of signals U_{in} and I_{in} is the frequency reference
- 13** Panel reference $r1$ is the frequency reference
- 14** Maximum reference selection (recommended only at torque control)
- 15** U_{in}/I_{in} digital selection (see par. 2.3)

1. 6 Jogging speed reference

Parameter value defines the jogging speed selected with the digital input

1. 7 Current limit

This parameter determines the maximum motor current from the frequency converter. To avoid motor overload, set this parameter according to the rated current of the motor.

1. 8 U/f ratio selection

Linear: The voltage of the motor changes linearly with the frequency in the constant flux area from 0 Hz to the field weakening point (par. 6. 3) where the nominal voltage is also supplied to the motor. See figure 5-2. Linear U/f ratio should be used in constant torque applications.

0

This default setting should be used if there is no special need for another setting.

Squared: 1 The voltage of the motor changes following a squared curve form with the frequency in the area from 0 Hz to the field weakening point (par. 6. 3) where the nominal voltage is also supplied to the motor. See figure 5-2.

The motor runs undermagnetised below the field weakening point and produces less torque and electromechanical noise. Squared U/f ratio can be used in applications where torque demand of the load is proportional to the square of the speed, e.g. in centrifugal fans and pumps.

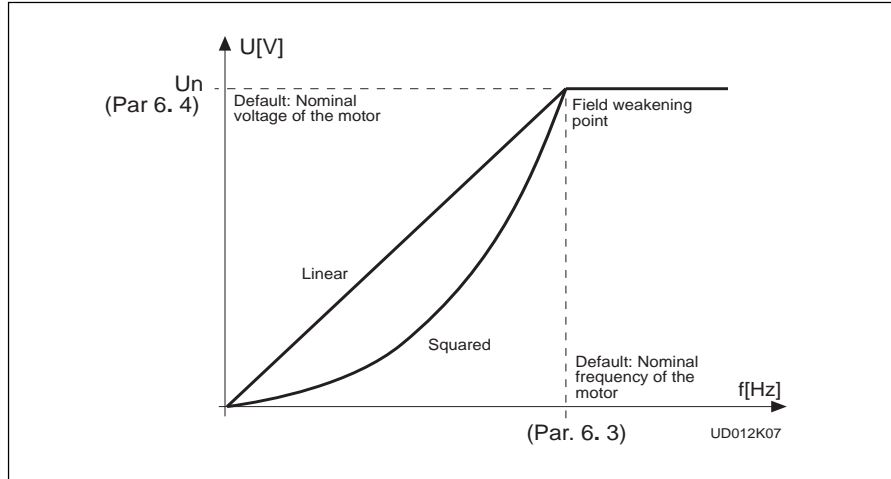

Figure 5-2 Linear and squared U/f curves.

Programm. U/f curve 2 The U/f curve can be programmed with three different points. The parameters for programming are explained in chapter 5.2. Programmable U/f curve can be used if the other settings do not satisfy the needs of the application. See figure 5-3.

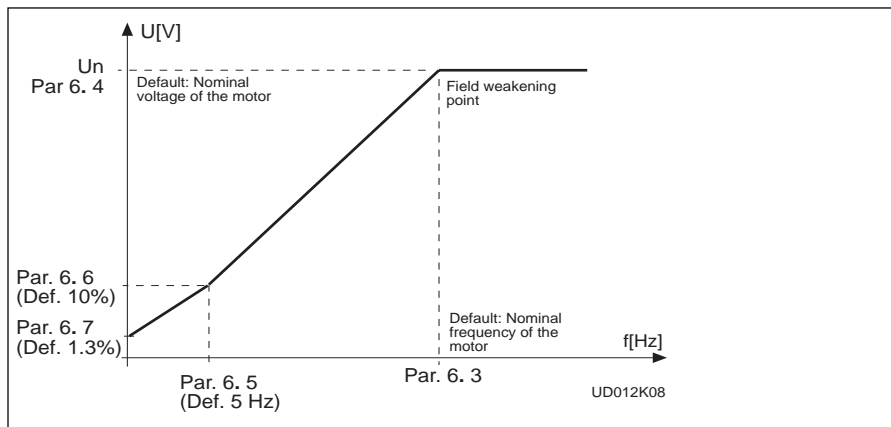

Figure 5-3 Programmable U/f curve.

1.9 U/f optimisation

Automatic torque boost The voltage to the motor changes automatically which makes the motor produce sufficient torque to start and run at low frequencies. The voltage increase depends on the motor type and power. Automatic torque boost can be used in applications where starting torque due to starting friction is high, e.g. in conveyors.

NOTE!

In high torque - low speed applications - it is likely the motor will overheat.

If the motor has to run a prolonged time under these

conditions, special attention must be paid to cooling the motor. Use external cooling for the motor if the temperature tends to rise too high.

1. 10 Nominal voltage of the motor

Find this value U_n on the rating plate of the motor.

This parameter sets the voltage at the field weakening point, parameter 6. 4, to $100\% \times U_{n\text{motor}}$.

1. 11 Nominal frequency of the motor

Find this value f_n on the rating plate of the motor.

This parameter sets the field weakening point, parameter 6. 3, to the same value.

1. 12 Nominal speed of the motor

Find this value n_n on the rating plate of the motor.

1. 13 Nominal current of the motor

Find this value I_n on the rating plate of the motor.

1. 14 Supply voltage

Set parameter value according to the nominal voltage of the supply.

Values are predefined for CX/CXL2, CX/CXL/CXS4, CX/CXL/CXS5 and CX6 ranges, see table 5-1.

1. 15 Parameter conceal

Defines which parameter groups are available for editing:

0 = all parameter groups are visible

1 = only group 1 is visible

1. 16 Parameter value lock

Defines access to the changes of the parameter values:





0 = parameter value changes enabled

1 = parameter value changes disabled

6 Special Parameters, Groups 2—10

6.1 Parameter tables

Group 2, Input signal parameters

Code	Parameter	Range	Step	Default	Description		Page
					DIA1	DIA2	
2.1	Start/Stop logic selection 	0—4	1	0	0 = Start forw. 1 = Start/Stop 2 = Start/Stop 3 = Start pulse 4 = Start/stop pulse	Start reverse Reverse Run enable Stop pulse Run enable	19
2.2	DIA3 function (terminal 10) 	0—12	1	7	0 = Not used 1 = External fault, closing contact 2 = External fault, opening contact 3 = Run enable 4 = Accel./decel. time selection 5 = Reverse 6 = Jogging speed 7 = Fault reset 8 = Accel./decel. operation prohibit 9 = DC-braking command 10 = Torque control 11 = Torque reference sign 12 = Run enable with coasting		20
2.3	DIB4 function (terminal 14) 	0—15	1	6	0 = Not used 1 = External fault, closing contact 2 = External fault, opening contact 3 = Run enable 4 = Accel./decel. time selection 5 = Reverse 6 = Jogging speed 7 = Fault reset 8 = Accel./decel. operation prohibit 9 = DC-braking command 10 = Multi-step speed select 1 11 = Selection between I_{in} and U_{in} 12 = Run enable with coasting 13 = Fieldbus control 14 = Par. 1.5 / U_{in} 15 = Par. 1.5 / I_{in}		22
2.4	DIB5 function (terminal 15) 	0—13	1	1	0 = Not used 1 = External fault, closing contact 2 = External fault, opening contact 3 = Run enable 4 = Accel./decel. time selection 5 = Reverse 6 = Jogging speed 7 = Fault reset 8 = Accel./decel. operation prohibit 9 = DC-braking command 10 = Multi-step speed select 2 11 = Motorised pot. speed up 12 = Run enable with coasting 13 = Fieldbus control		22
2.5	DIB6 function (terminal 16) 	0—13	1	4	0 = Not used 1 = External fault, closing contact 2 = External fault, opening contact 3 = Run enable 4 = Accel./decel. time selection 5 = Reverse 6 = Jogging speed 7 = Fault reset 8 = Accel./decel. operation prohibit 9 = DC-braking command 10 = Multi-step speed select 3 11 = Motorised pot. speed down 12 = Run enable with coasting 13 = Fieldbus control		22

Note!



= Parameter value can be changed only when the frequency converter is stopped. (Continues)

Code	Parameter	Range	Step	Default	Custom	Description	Page
2. 6	U _{in} signal range	0—2	1	0		0 = 0—10 V 1 = Custom setting range 2 = -10—+10 V (can be used with Joystick control only)	
2. 7	U _{in} custom setting min.	0—100%	0.01%	0.00%			22
2. 8	U _{in} custom setting max.	0—100%	0.01%	100.00%			22
2. 9	U _{in} signal inversion	0—1	1	0		0 = Not inverted 1 = Inverted	22
2. 10	U _{in} signal filter time	0—10s	0.01s	0.1s		0 = No filtering	22
2. 11	I _{in} signal range	0—2	1	0		0 = 0—20 mA 1 = 4—20 mA 2 = Custom setting range	23
2. 12	I _{in} custom setting minim.	0—100%	0.01%	0.00%			23
2. 13	I _{in} custom setting maxim.	0—100%	0.01%	100.00%			23
2. 14	I _{in} signal inversion	0—1	1	0		0 = Not inverted 1 = Inverted	23
2. 15	I _{in} signal filter time	0—10s	0.01s	0.1s		0 = No filtering	23
2. 16	U _{in} minimum scaling	-320,00%— +320,00 %	0%	0,01		0% = no minimum scaling	23
2. 17	U _{in} maximum scaling	-320,00%— +320,00 %	100%	0,01		100% = no maximum scaling	23
2. 18	I _{in} minimum scaling	-320,00%— +320,00 %	0%	0,01		0% = no minimum scaling	23
2. 19	I _{in} maximum scaling	-320,00%— +320,00 %	100%	0,01		100% = no maximum scaling	23
2. 20	Free analogue input, signal selection	0—5	1	0		0 = Not use 1 = U _{in} (analogue voltage input) 2 = I _{in} (analogue current input) 3 = Ain1 (option board) 4 = Ain2 (option board) 5 = Fieldbus signal	24
2. 21	Free analogue input, function	0—4	1	0		0 = No function 1 = Reduces current limit (par. 1.7) 2 = Reduces DC-braking current 3 = Reduces acc. and decel. times 4 = Reduces torque supervis. limit	24
2. 22	Motorised potentiometer ramp time	0.1—2000.0 Hz/s	0.1 Hz/s	10.0 Hz/s			25
2. 23	Option board Ain1 signal inversion	0—1	1	0		0 = Not inverted 1 = Inverted	25
2. 24	Option board Ain1 signal filter time	0—10s	0.01s	0.1s		0 = No filtering	25
2. 25	Option board Ain2 signal range	0—2	1	0		0 = 0—20 mA 1 = 4—20 mA 2 = 0—10 V	25
2. 26	Option board Ain2 signal inversion	0—1	1	0		0 = Not inverted 1 = Inverted	25
2. 27	Option board Ain2 signal filter time	0—10s	0.01s	0.1s		0 = No filtering	25

Note!  = Parameter value can be changed only when the frequency converter is stopped. (Continues)

Code	Parameter	Range	Step	Default	Custom	Description	Page
2.28	Adjust Input	0 - 5	1	0		0 = Not used 1 = Voltage input 2 = Current input 3 = AIN1 I/O-expand 4 = AIN2 I/O-expand 5 = FB signal	
2.29	Adjust Percentage	0.0% - 200.0%	0.1%	0.0%			
2.30	Adjust Offset	0.0% - 100.0%	0.1%	0.0%			

Note!  = Parameter value can be changed only when the frequency converter is stopped.

Group 3, Output and supervision parameters

Code	Parameter	Range	Step	Default	C u s t o m	Description	Page
3.1	Analogue output function	0—14	1	1		0 = Not used 1 = O/P frequency 2 = Motor speed 3 = O/P current 4 = Motor torque 5 = Motor power 6 = Motor voltage 7 = DC-link volt. 8 = Input signal U_{in} 9 = Input signal I_{in} 10 = Refer. freq. 11 = Refer. torque 12 = Motor±torque 13 = Motor±power 14 = O/P freq.	26
3.2	Analogue output filter time	0.01—10 s	0.01	1.00		Scale 100% (0— f_{max}) (0—max. speed (0— $2.0 \times I_{nC\bar{X}}$) (0— $2 \times T_{nC\bar{X}}$) (0— $2 \times P_{nC\bar{X}}$) (0— $100\% \times U_{nM}$) (0—1000 V)	26
3.3	Analogue output inversion	0—1	1	0		0 = Not inverted 1 = Inverted	26
3.4	Analogue output minimum	0—1	1	0		0 = 0 mA 1 = 4 mA	26
3.5	Analogue output scale	10—1000%	1%	100%			26
3.6	Digital output function	0—22	1	1		0 = Not used 1 = Ready 2 = Run 3 = Fault 4 = Fault inverted 5 = Vacon overheat warning 6 = External fault or warning 7 = Reference fault or warning 8 = Warning 9 = Reversed 10 = Jogging speed selected 11 = At speed 12 = Motor regulator activated 13 = Output frequency limit superv. 1 14 = Output frequency limit superv. 2 15 = Torque limit supervision 16 = Reference limit supervision 17 = External brake control 18 = Control from I/O terminals 19 = Frequency converter temperature limit supervision 20 = Unrequested rotation direction 21 = External brake control inverted 22 = Termistor fault or warning	27
3.7	Relay output 1 function	0—22	1	2		As parameter 3.6	27
3.8	Relay output 2 function	0—22	1	3		As parameter 3.6	27
3.9	Output frequency limit 1 supervision function	0—2	1	0		0 = No 1 = Low limit 2 = High limit	27
3.10	Output frequency limit 1 supervision value	0— f_{max} (par. 1.2)	0.1 Hz	0 Hz			27
3.11	Output frequency limit 2 supervision function	0—2	1	0		0 = No 1 = Low limit 2 = High limit	27
3.12	Output frequency limit 2 supervision value	0— f_{max} (par. 1.2)	0.1 Hz	0 Hz			27

Note!  = Parameter value can be changed only when the frequency converter is stopped. (Continues)

Code	Parameter	Range	Step	Default	Custom	Description	Page
3.13	Torque limit supervision function	0—2	1	0		0 = No 1 = Low limit 2 = High limit	28
3.14	Torque limit supervision value	0—200% $\times T_{nCX}$	1%	100%			28
3.15	Reference limit supervision function	0—2	1	0		0 = No 1 = Low limit 2 = High limit	28
3.16	Reference limit supervision value	0— f_{max} (par. 1.2)	0.1 Hz	0 Hz			28
3.17	Extern. brake Off-delay	0—100.0 s	0.1 s	0.5 s			28
3.18	Extern. brake On-delay	0—100.0 s	0.1 s	1.5 s			28
3.19	Frequency converter temperature limit supervision function	0—2	1	0		0 = No 1 = Low limit 2 = High limit	28
3.20	Frequency converter temperature limit value	-10—+75°C	1°C	+40°C			28
3.21	I/O-expander board (opt.) analogue output content	0—14	1	3		See parameter 3.1	—
3.22	I/O-expander board (opt.) analogue output filter time	0.01—10 s	0.01	1.00		See parameter 3.2	—
3.23	I/O-expander board (opt.) analogue output inversion	0—1	1	0		See parameter 3.3	—
3.24	I/O-expander board (opt.) analogue output minimum	0—1	1	0		See parameter 3.4	—
3.25	I/O-expander board (opt.) analogue output scale	10—1000%	1	100%		See parameter 3.5	—
3.26	Analog output offset (basic control board)	-100— 100,0%	1	100%			29
3.27	I/O-expander board (opt.) analogue output offset	-100— +100,0%	1	100%			29
3.28	Digital output DO1 on delay	0—320,00s	0,01	0,00		0,00 = delay not in use	29
3.29	Digital output DO1 off delay	0—320,00s	0,01	0,00		0,00 = delay not in use	29
3.30	Relay output RO1 on delay	0—320,00s	0,01	0,00		0,00 = delay not in use	29
3.31	Relay output RO1 off delay	0—320,00s	0,01	0,00		0,00 = delay not in use	29
3.32	Relay output RO1 on delay	0—320,00s	0,01	0,00		0,00 = delay not in use	29
3.33	Relay output RO2 off delay	0—320,00s	0,01	0,00		0,00 = delay not in use	29

Group 4, Drive control parameters







Code	Parameter	Range	Step	Default	Custom	Description	Page
4.1	Acc./Dec. ramp 1 shape	0—10 s	0.1 s	0		0 = Linear >0 = S-curve acc./dec. time	30
4.2	Acc./Dec. ramp 2 shape	0—10 s	0.1 s	0		0 = Linear >0 = S-curve acc./dec. time	30
4.3	Acceleration time 2	0.1—3000 s	0.1 s	10 s			31
4.4	Deceleration time 2	0.1—3000 s	0.1 s	10 s			31
4.5	Brake chopper 	0—1	1	0		0 = Brake chopper not in use 1 = Brake chopper in use 2 = External brake chopper	31
4.6	Start function	0—1	1	0		0 = Ramp 1 = Flying start	31
4.7	Stop function	0—1	1	0		0 = Coasting 1 = Ramp	31
4.8	DC-braking current	0.15—1.5 $\times I_{nCX}$ (A)	0.1 A	$0.5 \times I_{nCX}$			31
4.9	DC-braking time at Stop	0—250.0 s	0.1 s	0 s		0 = DC-brake is off at Stop	32
4.10	Execute freq. of DC-brake during ramp Stop	0.1—10 Hz	0.1 Hz	1.5 Hz			33
4.11	DC-brake time at Start	0.0—25.0 s	0.1 s	0 s		0 = DC-brake is off at Start	33
4.12	Multi-step speed reference 1	$f_{min} — f_{max}$ (1.1) (1.2)	0.1 Hz	10 Hz			33
4.13	Multi-step speed reference 2	$f_{min} — f_{max}$ (1.1) (1.2)	0.1 Hz	15 Hz			33
4.14	Multi-step speed reference 3	$f_{min} — f_{max}$ (1.1) (1.2)	0.1 Hz	20 Hz			33
4.15	Multi-step speed reference 4	$f_{min} — f_{max}$ (1.1) (1.2)	0.1 Hz	25 Hz			33
4.16	Multi-step speed reference 5	$f_{min} — f_{max}$ (1.1) (1.2)	0.1 Hz	30 Hz			33
4.17	Multi-step speed reference 6	$f_{min} — f_{max}$ (1.1) (1.2)	0.1 Hz	40 Hz			33
4.18	Multi-step speed reference 7	$f_{min} — f_{max}$ (1.1) (1.2)	0.1 Hz	50 Hz			33

Note!  = Parameter value can be changed only when the frequency converter is stopped.

Group 5, Prohibit frequency parameters

Code	Parameter	Range	Step	Default	Custom	Description	Page
5.1	Prohibit frequency range 1 low limit	0— f_{max} (1. 2)	0.1 Hz	0 Hz			33
5.2	Prohibit frequency range 1 high limit	0— f_{max} (1. 2)	0.1 Hz	0 Hz		0 = Prohibit range 1 is off	33
5.3	Prohibit frequency range 2 low limit	0— f_{max} (1. 2)	0.1 Hz	0 Hz			33
5.4	Prohibit frequency range 2 high limit	0— f_{max} (1. 2)	0.1 Hz	0 Hz		0 = Prohibit range 2 is off	33
5.5	Prohibit frequency range 3 low limit	0— f_{max} (1. 2)	0.1 Hz	0 Hz			33
5.6	Prohibit frequency range 3 high limit	0— f_{max} (1. 2)	0.1 Hz	0 Hz		0 = Prohibit range 3 is off	33

Group 6, Motor control parameters

Code	Parameter	Range	Step	Default	Custom	Description	Page
6.1	Motor control mode 	0—2	1	0		0 = Frequency control 1 = Speed control (open loop) 2 = Torque control (open loop)	33
6.2	Switching frequency	1—16 kHz	0.1 kHz	10/3.6 kHz		Dependant on kW	34
6.3	Field weakening point 	30—500 Hz	1 Hz	Param. 1. 11			34
6.4	Voltage at field weakening point 	15—200% $\times U_{nmot}$	1%	100%			34
6.5	U/F-curve mid point frequency 	0—500 Hz	0,1 Hz	0 Hz			34
6.6	U/F-curve mid point voltage 	0—100% $\times U_{nmot}$	0.01%	0 %			34
6.7	Output voltage at zero frequency 	0—100% $\times U_{nmot}$	0.01%	0 %			34
6.8	Overvoltage controller 	0—1	1	1		0 = Controller is not operating 1 = Controller is operating	35
6.9	Undervoltage controller	0—1	1	1		0 = Controller is not operating 1 = Controller is operating	35

Note!

= Parameter value can be changed only when the frequency converter is stopped.

Group 7, Protections

Code	Parameter	Range	Step	Default	Custom	Description	Page
7.1	Response to reference fault	0—3	1	0		0 = No action 1 = Warning 2 = Fault, stop according to par 4.7 3 = Fault, stop always by coasting	35
7.2	Response to external fault	0—3	1	2		0 = No action 1 = Warning 2 = Fault, stop according to par 4.7 3 = Fault, stop always by coasting	35
7.3	Phase supervision of the motor	0—2	1	2		0 = No action 1 = Warning 2 = Fault	35
7.4	Earth fault protection	0—2	1	2		0 = No action 1 = Warning 2 = Fault	35
7.5	Motor thermal protection	0—2	1	2		0 = No action 1 = Warning 2 = Fault	36
7.6	Motor thermal protection break point current	50.0—150 % $\times I_{nMOTOR}$	1.0 %	100.0%			36
7.7	Motor thermal protection zero frequency current	10.0—150% $\times I_{nMOTOR}$	1.0 %	45.0%			37
7.8	Motor thermal protection time constant	0.5—300.0 minutes	0,5 min.			Default value is set according to motor nominal current	37
7.9	Motor thermal protection break point frequency	10—500 Hz	1 Hz	35 Hz			38
7.10	Stall protection	0—2	1	1		0 = No action 1 = Warning 2 = Fault	38
7.11	Stall current limit	10.0—200% $\times I_{nMOTOR}$	1.0%	130.0%			39
7.12	Stall time	2.0—120 s	1.0 s	15.0 s			39
7.13	Maximum stall frequency	1— f_{max}	1 Hz	25 Hz			39
7.14	Underload protection	0—2	1	0		0 = No action 1 = Warning 2 = Fault	40
7.15	Underload prot., field weakening area load	20.0—150 % $\times T_{nMOTOR}$	1.0%	50.0%			40
7.16	Underload protection, zero frequency load	10.0—150.0% $\times T_{nMOTOR}$	1.0%	10.0%			40
7.17	Underload time	2.0—600.0 s	1.0 s	20.0s			40
7.18	Phase supervision of the supply voltage	0—2	1	2		0 = No action 1 = Warning 2 = Fault	41
7.19	Termistor input of I/O-Expander	0—2	1	2		0 = No action 1 = Warning 2 = Fault	41
7.20	Response to fieldbus fault	0—2	1	0		0 = Not used 1 = Warning 2 = Fault	41

Group 8, Autorestart parameters

Code	Parameter	Range	Step	Default	Custom	Description	Page
8.1	Automatic restart: number of tries	0—10	1	0		0 = not in use	41
8.2	Automatic restart: trial time	1—6000 s	1 s	30 s			41
8.3	Automatic restart: start function	0—1	1	0		0 = Ramp 1 = Flying start	42
8.4	Automatic restart of undervoltage	0—1	1	0		0 = No 1 = Yes	42
8.5	Automatic restart of overvoltage	0—1	1	0		0 = No 1 = Yes	42
8.6	Automatic restart of overcurrent	0—1	1	0		0 = No 1 = Yes	42
8.7	Automatic restart of reference fault	0—1	1	0		0 = No 1 = Yes	42
8.8	Automatic restart after over/undertemperature fault	0—1	1	0		0 = No 1 = Yes	42

Group 9, Torque Control

Code	Parameter	Range	Step	Default	Custom	Description	Page
9.1	Torque reference selection	0—6	1	0		0 = None 1 = U_{in} 2 = I_{in} 3 = Panel Trq reference r2 4 = Ain1 (option board) 5 = Ain2 (option board) 6 = Fieldbus control	43
9.2	Torque reference scaling bias	-100%-- +100%	1	0		0 = Not in use	43
9.3	Torque reference scaling gain	-320%-- +320%	1	100		100 = No scaling	43
9.4	TC time constant	1—1000 ms	1 ms	15 ms			43
9.5	TC minimum control limit	0—10.00 Hz	0.01 Hz	3.00 Hz			43

Group 10, Fieldbus parameters

Code	Parameter	Range	Step	Default	Custom	Description	Page
10.1	Fieldbus control select	0—1	1	0		0 = Control via I/O terminals 1 = Control via Fieldbus board	44
10.2	DIC1 function (term. 301, fieldbus board)	0—1	0	1		0 = Fieldbus control 1 = External fault	44
10.3	MODBUS Slave address	1—247	1	1			44
10.4	Baud rate	1—7	1	6		1 = 300 baud 2 = 600 baud 3 = 1200 baud 4 = 2400 baud 5 = 4800 baud 6 = 9600 baud 7 = 19200 baud	44
10.5	MB Parity type	0—2	1	0		0 = None 1 = Even 2 = Odd	44
10.6	Modbus time-out	0—3600 s	1 s	0 s		0 = No time-out	44
10.7	Profibus slave address	2—126	1	126			44
10.8	Profibus baud rate	1—10	1	10		1 = 9.6 kbaud 2 = 19.2 kbaud 3 = 93.75 kbaud 4 = 187.5 kbaud 5 = 500 kbaud 6 = 1.5 Mbaud 7 = 3 Mbaud 8 = 6 Mbaud 9 = 12 Mbaud 10 = AUTO	45
10.9	Profibus PPO Type	1—4	1	1		1 = PPO 1 2 = PPO 2 3 = PPO 3 4 = PPO 4	45
10.10	Profibus Process Data 1	0—99	1	1			45
10.11	Profibus Process Data 2	0—99	1	2			45
10.12	Profibus Process Data 3	0—99	1	3			45
10.13	Profibus Process Data 4	0—99	1	99			45
10.14	LonWorks Service Button	0—1	1	0			45

Table 6-1. Special parameters, Groups 2-10

6.2 Description of Groups 2—10 parameters

2.1 Start/Stop logic selection

- 0:** DIA1: closed contact = start forward
 DIA2: closed contact = start reverse,
 See figure 6-1.

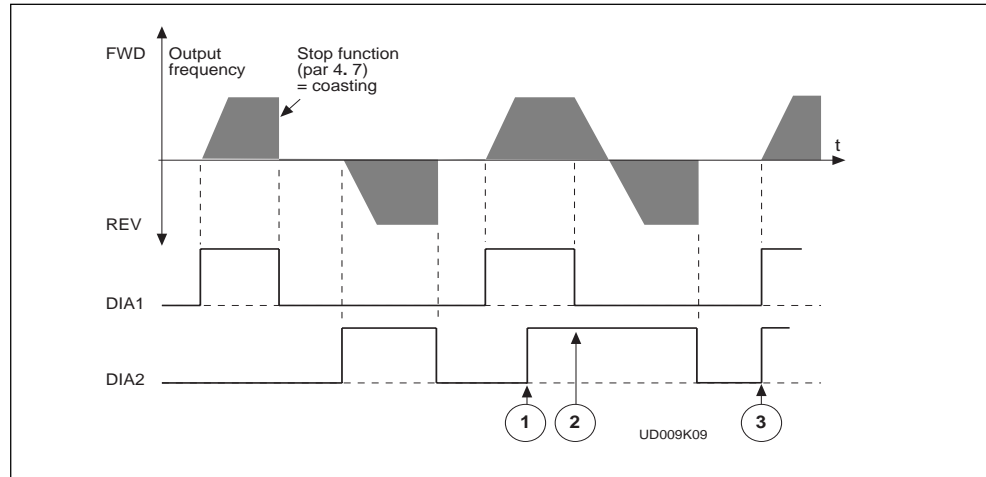

Figure 6-1 Start forward/Start reverse.

- ① The first selected direction has the highest priority
 - ② When DIA1 contact opens, the direction of rotation starts to change
 - ③ If Start forward (DIA1) and Start reverse (DIA2) signals are active simultaneously, the Start forward signal (DIA1) has priority.
- 1:** DIA1: closed contact = start open contact = stop
 DIA2: closed contact = reverse open contact = forward
 See figure 6-2.

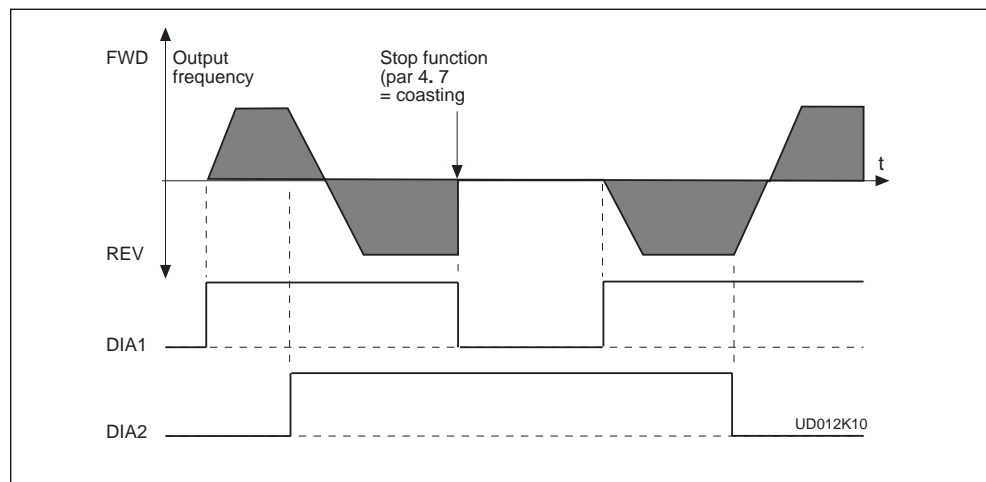

Figure 6-2 Start, Stop, reverse.

- 2:** DIA1: closed contact = start open contact = stop
 DIA2: closed contact = start enabled open contact = start disabled

- 3:** 3-wire connection (pulse control):
 DIA1: closed contact = start pulse
 DIA2: closed contact = stop pulse
 (DIA3 can be programmed for reverse command)
 See figure 6-3

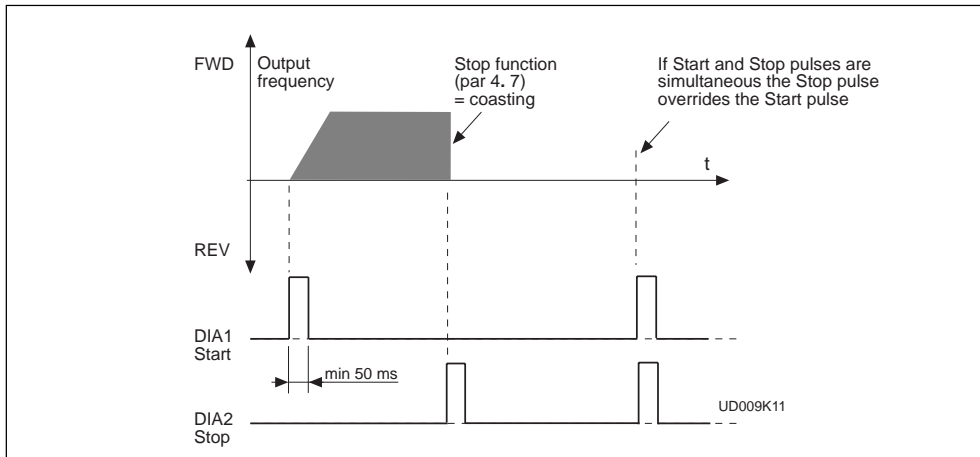

Figure 6.3 Start pulse / Stop pulse

- 4:** DIA1: closed contact = start/stop pulse
 DIA2: closed contact = start enabled

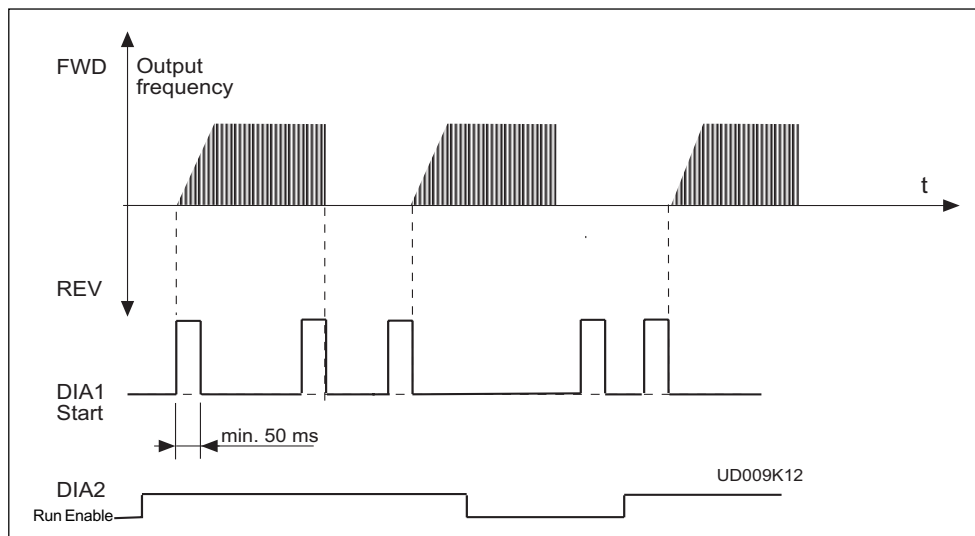

Figure 6-4. Start / Stop pulse, Run enable.

2.2 DIA3 function

1: External fault, closing contact =

Fault is shown and motor is stopped when the input is active.

2: External fault, opening contact =

Fault is shown and motor is stopped when the input is not active.

3: Run enable

contact open = Motor start disabled

contact closed = Motor start enabled

4: Acc./Dec contact open = Acceleration/deceleration time 1 selected

time select. contact closed = Acceleration/deceleration time 2 selected

5: Reverse

contact open = Forward Can be used for reversing if

contact closed = Reverse parameter 2.1 has value 3

6: Jogg. speed

contact closed = Jogging speed selected for freq. reference

7: Fault reset

contact closed = Resets all faults

8: Acc./Dec. operation prohibited

contact closed = Stops acceleration or deceleration until the contact is opened

9: DC-braking command contact closed =

In Stop mode, the DC-braking operates until the contact is opened,

see figure 6.5. DC-brake current is set with parameter 4.8.

10: Torque control

contact closed = Forces the motor control mode to torque control, refer to par. 6.1

11: Torque reference sign

This selection changes the sign of the torque reference

12: Run enable with coasting

contact open = Run and start disabled (stop always with coasting)

contact closed = Motor run enabled

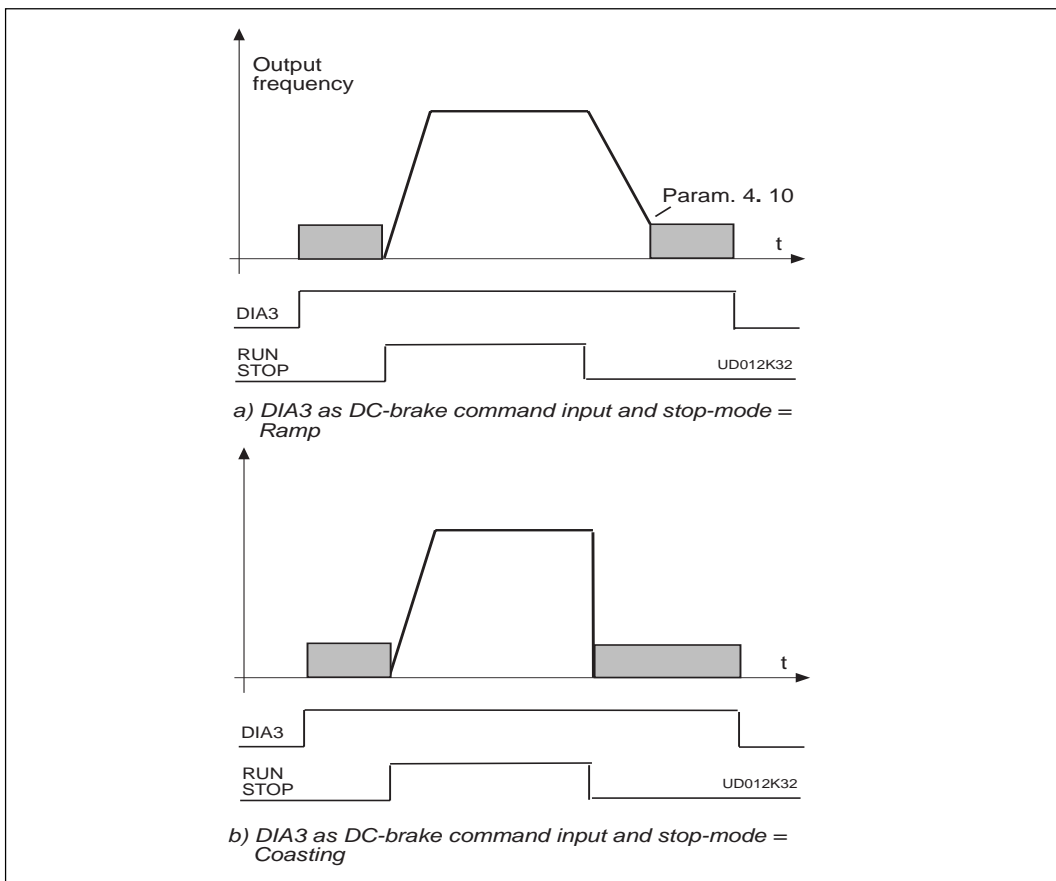

Figure 6-5 DIA3 as DC-brake command input: a) Stop-mode = Ramp, b) Stop-mode = Coasting.

2. 3 DIB4 function

Selections are the same as in 2. 2 except :

10: Multi-Step contact closed = Selection 1 active
speed select 1

11: U_{in}/I_{in} digital selection for frequency reference

13: Fieldbus control: Selection between I/O and fieldbus control

14: Parameter 1.5 / U_{in}

15: Parameter 1.5 / I_{in}

2. 4 DIB5 function

Selections are the same as in 2. 2 except :

10: Multi-Step contact closed = Selection 2 active
speed select 2

11: Motor pot. contact closed = Reference decreases until the contact is
UP opened

13: Fieldbus control: Selection between I/O and fieldbus control

2. 5 DIB6 function

Selections are the same as in 2. 2 except :

10: Multi-Step contact closed = Selection 3 active
speed select 3

11: Motor pot. contact closed = Reference decreases until the contact is
DOWN opened

13: Fieldbus control: Selection between I/O and fieldbus control

Note! (Par. 2.3, 2.4, 2.5): In the fieldbus control par. 10.1 = 1 and 10.2 = 0.

2. 6 U_{in} signal range

0 = Signal range 0—+10 V

1 = Custom setting range from custom minimum (par. 2. 4) to custom maximum (par. 2. 5)

2 = Signal range -10—+10 V , can be used only with Joystick control

2. 7 U_{in} custom setting minimum/maximum**2. 8**

With these parameters, U_{in} can be set for any input signal span within 0—10 V.

Minimum setting: Set the U_{in} signal to its minimum level, select parameter 2. 4, press the Enter button

Maximum setting: Set the U_{in} signal to its maximum level, select parameter 2. 5, press the Enter button

Note! These parameters can only be set with this procedure (not with the Browser buttons)

2. 9 U_{in} signal inversion

Parameter 2. 9 = 0, no inversion of analogue U_{in} signal.

Parameter 2. 9 = 1, inversion of analogue U_{in} signal.

2. 10 U_{in} signal filter time

Filters out disturbances from the incoming analogue U_{in} signal.

Long filtering time makes regulation response slower.

See figure 6-6.

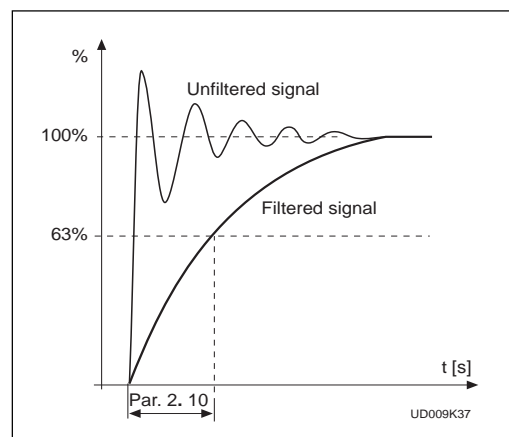

Figure 6-6 U_{in} signal filtering.

2. 11 Analogue input I_{in} signal range

0 = 0—20 mA

1 = 4—20 mA

2 = Custom signal span

2. 12 Analogue input I_{in} custom setting minimum/maximum

With these parameters, the scaling of the input current signal (I_{in}) range can be set between 0—20 mA.

Minimum setting:

Set the I_{in} signal to its minimum level, select parameter 2. 12, press the Enter button.

Maximum setting:

Set the I_{in} signal to its maximum level, select parameter 2. 13, press the Enter button.

Note! These parameters can only be set by this procedure (not with the browser buttons)

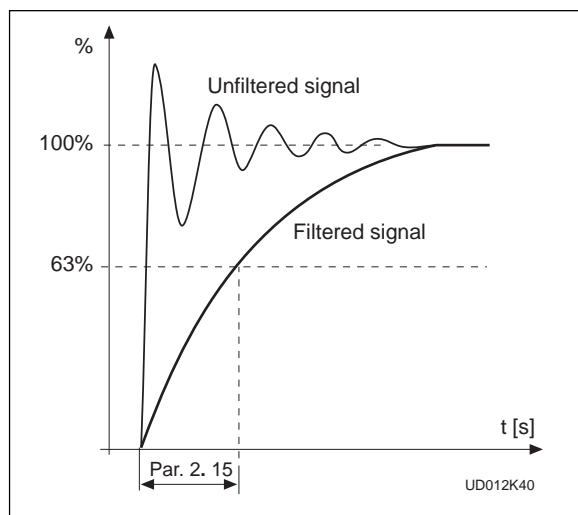

Figure 6-7 Analogue input I_{in} filter time

2. 14 Analogue input I_{in} inversion

Parameter 2. 14 = 0, no inversion of I_{in} input

Parameter 2. 14 = 1, inversion of I_{in} input.

2. 15 Analogue input I_{in} filter time

Filters out disturbances from the incoming analog I_{in} signal.

Long filtering time makes regulation response slower.

See figure 6-7.

2. 16 U_{in} signal minimum scaling

Sets the minimum scaling point for U_{in} signal. See figure 6-8.

2. 17 U_{in} signal maximum scaling

Sets the maximum scaling point for U_{in} signal. See figure 6-8.

2. 18 I_{in} signal minimum scaling

Sets the minimum scaling point for I_{in} signal. See figure 6-8.

2. 19 I_{in} signal maximum scaling

Sets the maximum scaling point for I_{in} signal. See figure 6-8.

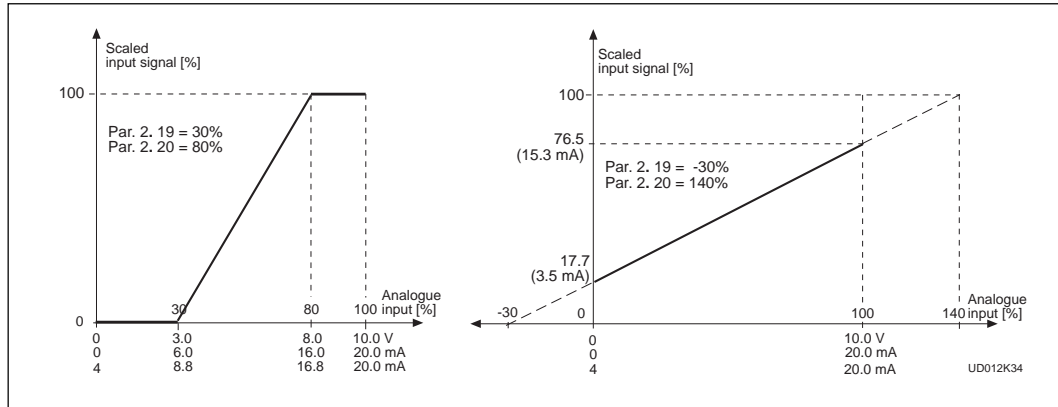

Figure 6-8 Examples of the scaling of U_{in} and I_{in} inputs .

2. 20 Free analogue input signal

Selection of input signal of free analogue input (an input not used for reference signal):

- 0 = Not in use
- 1 = Voltage signal U_{in}
- 2 = Current signal I_{in}
- 3 = Voltage signal A_{in1} from terminals 202-203 of I/O Expander
- 4 = Analogue signal A_{in2} from terminal 204-205 of I/O Expander
 - current signal Vacon CX 100 Opt
 - voltage signal Vacon CX 102 Opt
- 5 = Fieldbus signal
 - the signal comes through the fieldbus and depends on the option board used

2. 21 Free analogue input signal function

This parameter sets the function of the free analogue input:

- 0** = Function is not used
- 1** = Reducing motor current limit (par. 1. 7)

This signal will adjust the maximum motor current between 0 and parameter max. limit set with parameter 1.7. See figure 6-9.

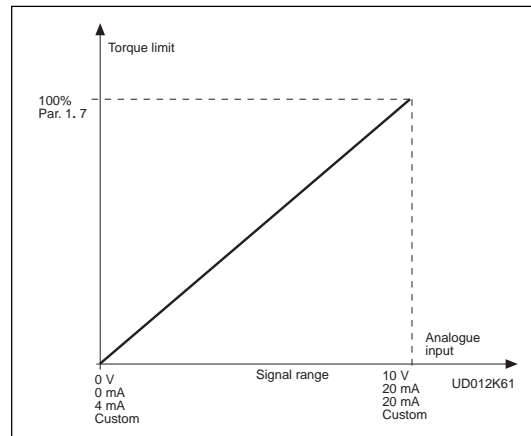

Figure 6-9 Reducing of max. motor current.

- 2** = Reducing DC brake current.

The DC braking current can be reduced with the free analogue input signal, between $0.15 \times I_{nCX}$ and current set with parameter 4. 8. See figure 6-10.

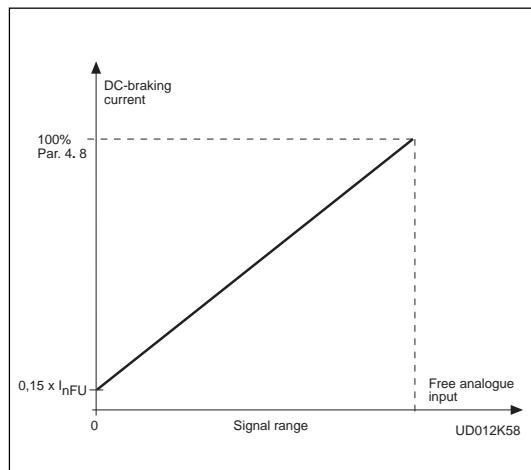

Figure 6-10 Reducing DC brake current.

3 Reducing acceleration and deceleration times.

The acceleration and deceleration times can be reduced with the free analogue input signal, according to the following formula:

Reduced time = set acc./eceler. time (par. 1. 3, 1. 4; 4. 3, 4. 4) divided by the factor R from figure 6-11.

Figure 6-11 Reducing acceleration and deceleration times.

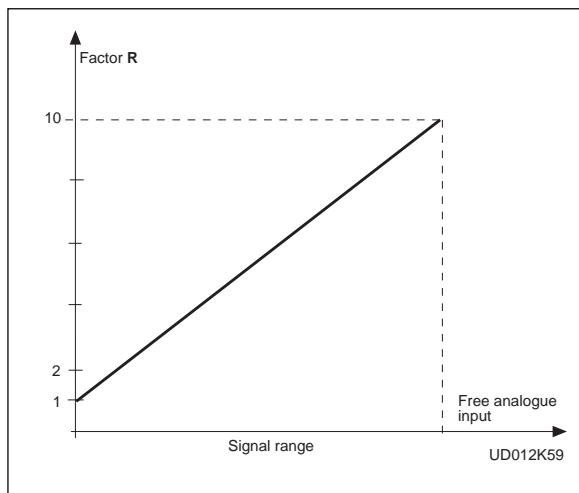

4 Reducing torque supervision limit.

The set torque supervision limit can be reduced with the free analogue input signal between 0 and set supervision limit (par. 3. 14), see figure 6-12.

Figure 6-12 Reducing torque supervision limit.

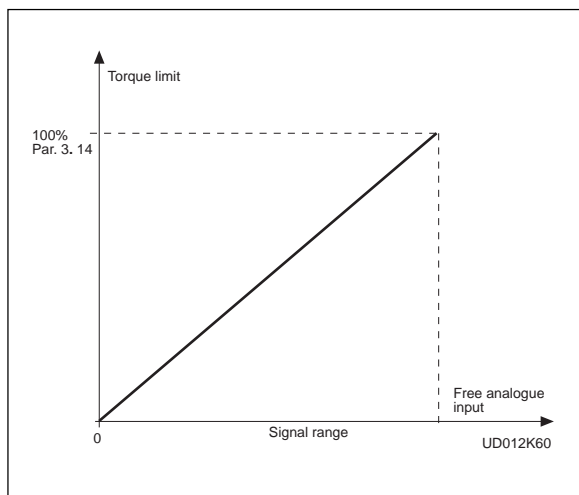

2.22 Motor potentiometer ramp time

Defines how fast the electronic motor potentiometer value changes.

2.23 Ain1 signal inversion (I/O-Expander)

Parameter 2.23 = 0, no inversion

2.24 Ain1 signal filter time

Filters out disturbances from the incoming analogue Ain1 signal. Long filtering time makes regulation response slower.

2.25 Ain2 input (I/O-Expander) signal range

- 0 = 0—20 mA
- 1 = 4—20 mA
- 2 = 0—10 V (must be used with 102 OPT)

2.26 Ain2 signal inversion (I/O-Expander)

Parameter 2.26 = 0, no inversion

2.27 Ain2 signal filter time (I/O-Expander)

Filters out disturbances from the incoming analogue Ain2 signal. Long filtering time makes regulation response slower.

2.28 Adjust Input

Range: 0 - 5

Step: 1

Default: 0

Description:

0 = Not Used

1 = Voltage Input

2 = Current Input

3 = AIN1 I/O-expand

4 = AIN2 I/O-expand

5 = FB signal

2.29 Adjust Percentage

Range: 0.0% - 200.0%

Step: 0.1%

Default: 0.0%

2.30 Adjust Offset

Range: 0.0% - 100.0%

Step: 0.1%

Default: 0.0%

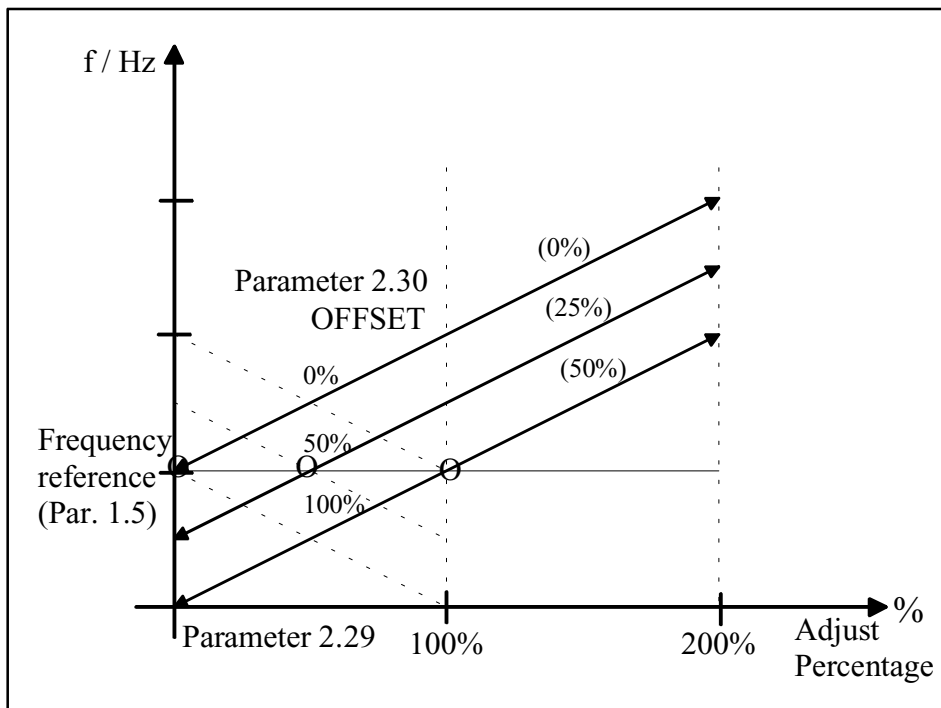

Figure 6-13. parameter 2.29 and 2.30 settings.

3.1 Analogue output function

See table on page 12.

3.2 Analogue output filter time

Filters the analogue output signal. See figure 6-13.

Figure 6-13 Analogue output filtering.

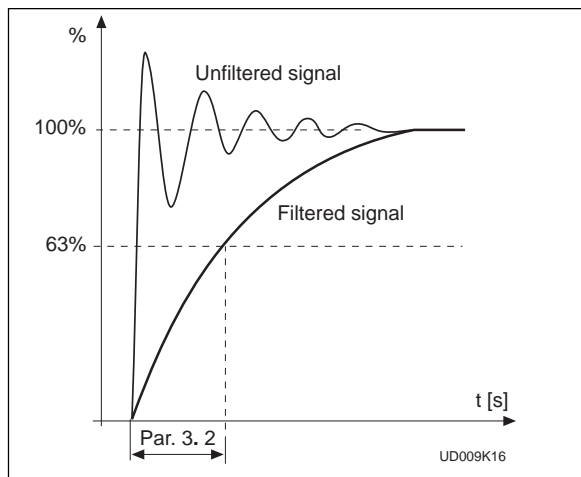

3.3 Analogue output invert

Inverts analogue output signal:
 max. output signal = minimum set value
 min. output signal = maximum set value

Figure 6-14 Analogue output invert.

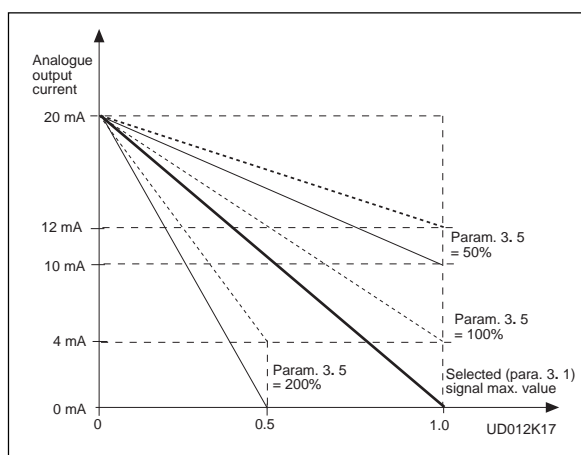

3.4 Analogue output minimum

Defines the signal minimum to be either 0 mA or 4 mA (living zero). See figure 6-15.

3.5 Analogue output scale

Scaling factor for analogue output. See figure 6-15.

Signal	Max. value of the signal
Output frequency	Max. frequency (p. 1. 2)
Motor speed	Max. speed ($n_n \times f_{max} / f_n$)
Output current	$2 \times I_{nCX}$
Motor torque	$2 \times T_{nCX}$
Motor power	$2 \times P_{nCX}$
Motor voltage	$100\% \times U_{nmotor}$
DC-link volt.	1000 V
Uin signal	Max Uin
Iin signal	Max Iin

Figure 6-15 Analogue output scale.

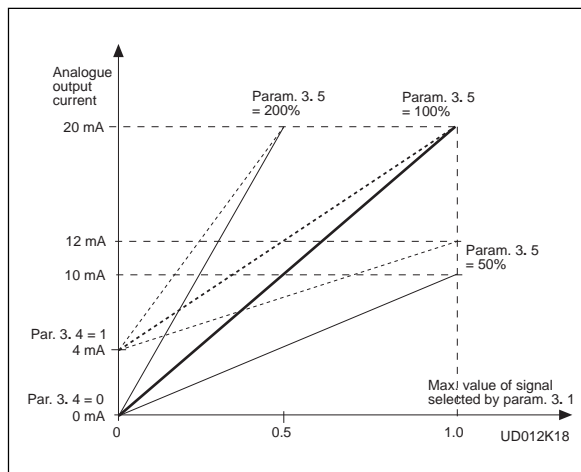

- 3.6 Digital output function**
3.7 Relay output 1 function
3.8 Relay output 2 function

Setting value	Signal content
0 = Not used	Out of operation Digital output DO1 sinks the current and programmable relay (RO1, RO2) is activated when:
1 = Ready	The frequency converter is ready to operate
2 = Run	The frequency converter operates (motor is running)
3 = Fault	A fault trip has occurred
4 = Fault inverted	A fault trip <u>has not</u> occurred
5 = Vacon overheat warning	The heat-sink temperature exceeds +70°C
6 = External fault or warning	Fault or warning depending on parameter 7. 2
7 = Reference fault or warning	Fault or warning depending on parameter 7. 1 - if analogue reference is 4—20 mA and signal is <4mA
8 = Warning	Always if a warning exists
9 = Reversed	The reverse command has been selected
10= Jogging speed	Jogging speed has been selected with digital input
11= At speed	The output frequency has reached the set reference
12= Motor regulator activated	Overvoltage or overcurrent regulator was activated
13= Output frequency supervision 1	The output frequency goes outside of the set supervision Low limit/ High limit (par. 3. 9 and 3. 10)
14= Output frequency supervision 2	The output frequency goes outside of the set supervision Low limit/ High limit (par. 3. 11 and 3. 12)
15= Torque limit supervision	The motor torque goes outside of the set supervision Low limit/ High limit (par. 3. 13 and 3. 14)
16= Reference limit supervision	Reference goes outside of the set supervision Low limit/ High limit (par. 3. 15 and 3. 16)
17= External brake control	External brake ON/OFF control with programmable delay (par 3. 17 and 3. 18)
18= Control from I/O terminals	External control mode selected with progr. push-button #2
19= Frequency converter temperature limit supervision	Temperature on frequency converter goes outside the set supervision limits (par. 3. 19 and 3. 20)
20= Unrequested rotation direction	Rotation direction of the motor shaft is different from the requested one
21 = External brake control inverted	External brake ON/OFF control (par. 3.17 and 3.18), output active when brake control is OFF
22 = Termistor fault or warning	The termistor input of option board indicates overtemperature. Fault or warning depending on parameter 7.19

Table 6-2 Output signals via DO1 and output relays RO1 and RO2.

- 3.9 Output frequency limit 1, supervision function**
3.11 Output frequency limit 2, supervision function

0 = No supervision

1 = Low limit supervision

2 = High limit supervision

If the output frequency goes under/over the set limit (3. 10, 3. 12) this function generates a warning message via the digital output DO1 and via a relay output RO1 or RO2 depending on the settings of the parameters 3. 6—3. 8.

- 3.10 Output frequency limit 1, supervision value**
3.12 Output frequency limit 2, supervision value

The frequency value to be supervised by the parameter 3. 9 (3. 11).

See figure 6-16.

3. 13 Torque limit , supervision function

0 = No supervision
 1 = Low limit supervision
 2 = High limit supervision
 If the calculated torque value goes under/over the set limit (3. 14) this function generates a warning message via the digital output DO1, via a relay output RO1 or RO2 depending on the settings of the parameters 3. 6—3. 8.

Figure 6-16 Output frequency supervision.

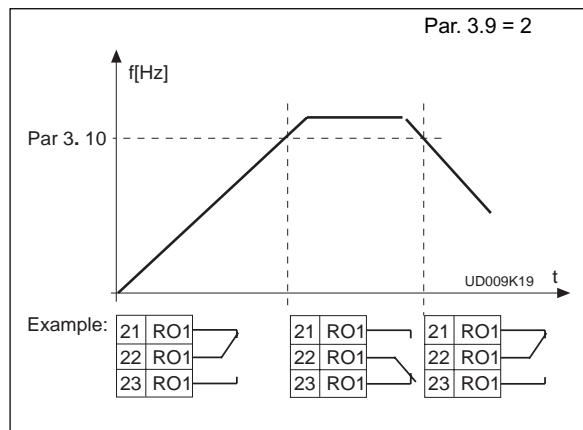

3. 14 Torque limit , supervision value

The calculated torque value to be supervised by the parameter 3. 13.

3. 15 Reference limit , supervision function

0 = No supervision
 1 = Low limit supervision
 2 = High limit supervision
 If the reference value goes under/over the set limit (3. 16) this function generates a warning message via the digital output DO1 or via a relay output RO1 or RO2 depending on the settings of the parameters 3. 6—3. 8. The supervised reference is the currently active reference. It can be source A or B reference depending on DIB6 input or the panel reference if panel is the active control source.

3. 16 Reference limit , supervision value

The frequency value to be supervised by the parameter 3. 15.

3. 17 External brake-off delay

3. 18 External brake-on delay

With these parameters the timing of external brake can be linked to the Start and Stop control signals, see Figure 6-18.
 The brake control signal can be programmed via the digital output DO1 or via one of relay outputs RO1 and RO2, see parameters 3. 6—3. 8.

3. 19 Frequency converter temperature limit supervision function

0 = No supervision
 1 = Low limit supervision
 2 = High limit supervision
 If the temperature of the frequency converter goes under/over the set limit (3. 20) this function generates a warning message via the digital output DO1 or via the relay outputs RO1 or RO2 depending on the settings of the parameters 3. 6—3. 8.

3. 20 Frequency converter temperature limit value

The temperature value to be supervised by the parameter 3. 19.

3.21 I/O-expander board (opt.) analogue output content

0 = Not used	Scale 100%
1 = O/P frequency	$(0—f_{max})$
2 = Motor speed	$(0—max. speed)$
3 = O/P current	$(0—2.0 \times I_{nCX})$
4 = Motor torque	$(0—2 \times T_{nCX})$
5 = Motor power	$(0—2 \times P_{nCX})$
6 = Motor voltage	$(0—100\% \times U_{nM})$
7 = DC-link volt.	$(0—1000 V)$
8 = Input signal U_{in}	
9 = Input signal I_{in}	
10 = Refer. freq.	
11 = Refer. torque	
12 = Motor±torque	$(-2—+2 \times T_{nMOT})$
13 = Motor±power	$(-2—+2 \times T_{nMOT})$
14 = O/P freq.	$(f_{min}—f_{max})$

3.22 I/O-expander board (opt.) analogue output filter time

Range is 0.01 - 10 s

Step: 0.01

Default: 1.00

3.23 I/O-expander board (opt.) analogue output inversion

0 = No inverted

1 = Inverted

Default: 0 = no inverted

3.24 I/O-expander board (opt.) analogue output minimum

0 = 0 mA

1 = 4 mA

Default: 0 = 0 mA

3.25 I/O-expander board (opt.) analogue output scale

Range is 10% - 1000%

Step: 1%

Default: 100%

3.26 Analogue output offset
3.27 I/O-Expander analogue output offset

With these parameters the offsets of the basic control board and I/O-Expander analogue outputs can be set. See figure 6-17.

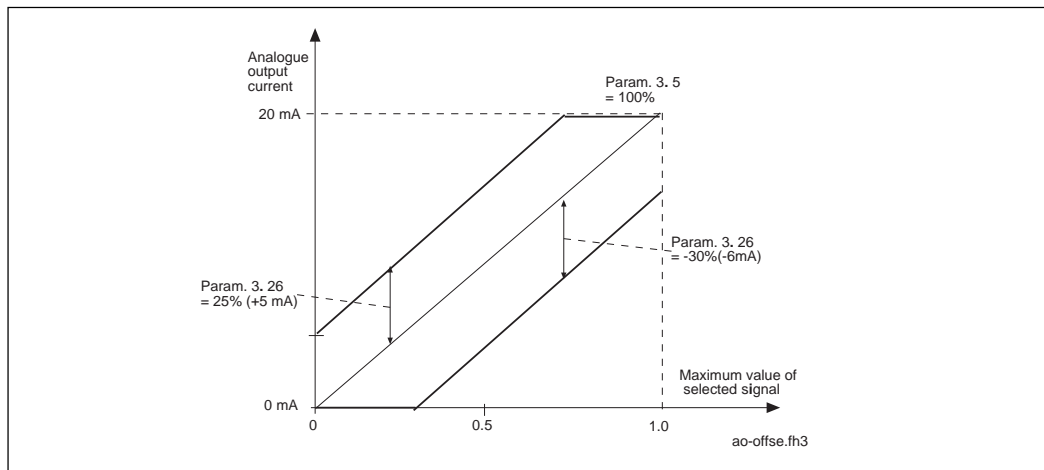

Figure 6-17. Analogue output offset

- 3.28 Digital output DO1 on-delay**
- 3.29 Digital output DO1 off-delay**
- 3.30 Relay output RO1 on-delay**
- 3.31 Relay output RO1 off-delay**
- 3.32 Relay output RO2 on-delay**
- 3.33 Relay output RO2 off-delay**

With these parameters it is possible to set on- and off-delays to digital and relay outputs. See figure 6-18.

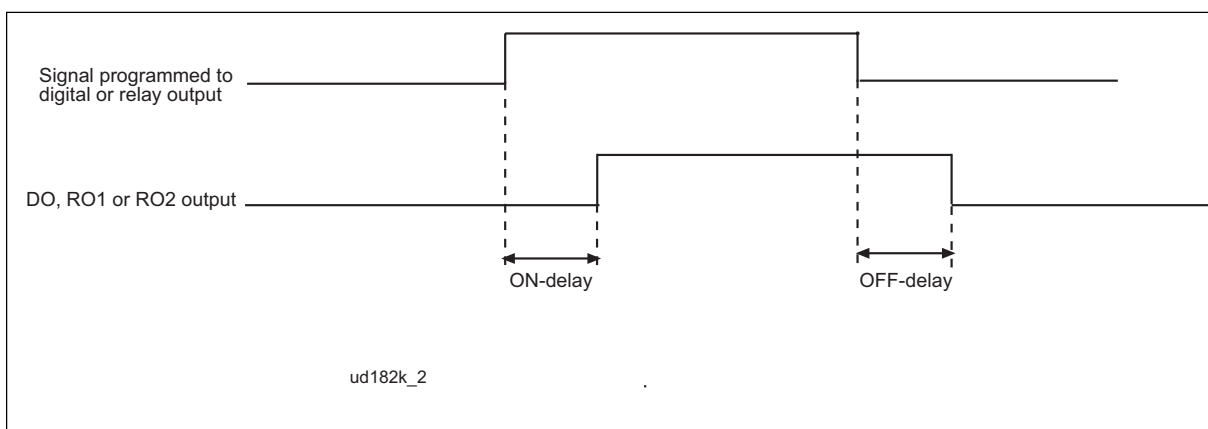

Figure 6-18. Digital and relay outputs. On- and off-delays

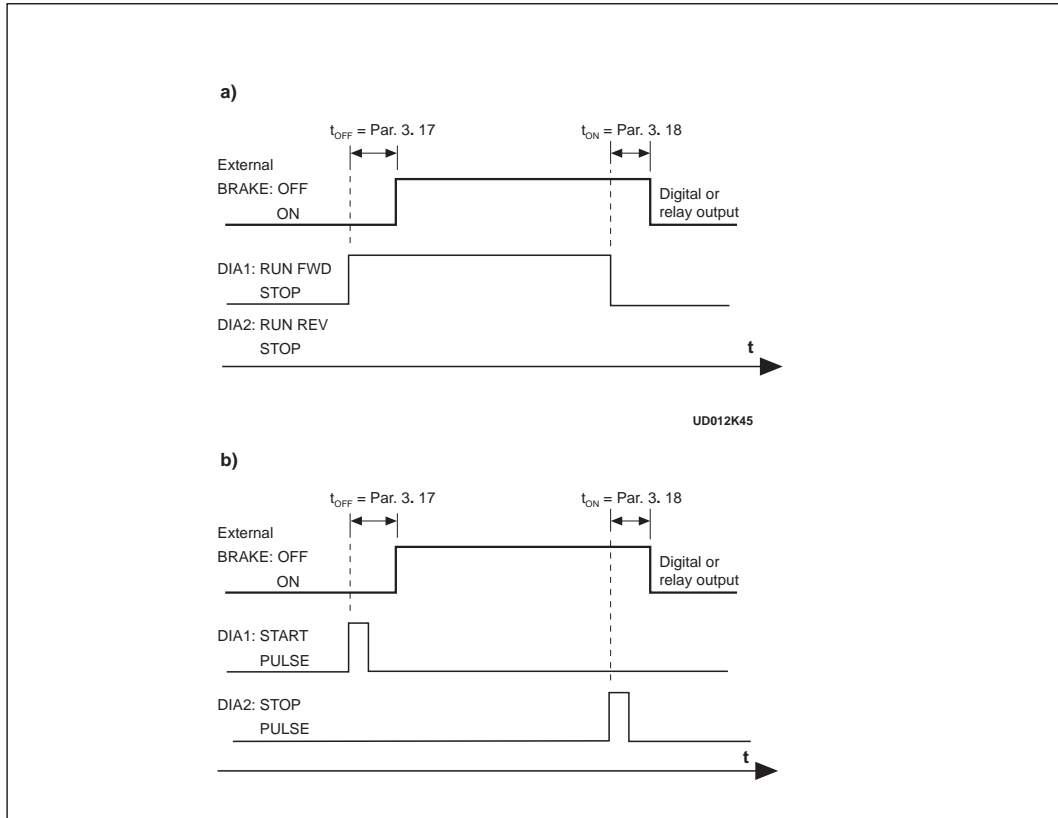

Figure 6-19 External brake control: a) Start/Stop logic selection par. 2. 1 = 0, 1 or 2
 b) Start/Stop logic selection par. 2. 1 = 3.

4. 1 Acc/Dec ramp 1 shape
4. 2 Acc/Dec ramp 2 shape

The start and end of the acceleration and deceleration ramps can be smoothed with these parameters. Setting value 0 gives linear ramp shape which causes acceleration and deceleration to act immediately to the changes in the reference signal with the time constant set by the parameter 1. 3 and 1. 4 (4. 3 and 4. 4).

Setting value 0.1—10 seconds for 4. 1 (4. 2) causes linear acceleration/deceleration to adopt an S-shape. Parameter 1. 3 and 1. 4 (4. 3 and 4. 4) determines the time constant of acceleration/deceleration in the middle of the curve. See figure 6-20.

Figure 6-20 S-shaped acceleration/ deceleration.

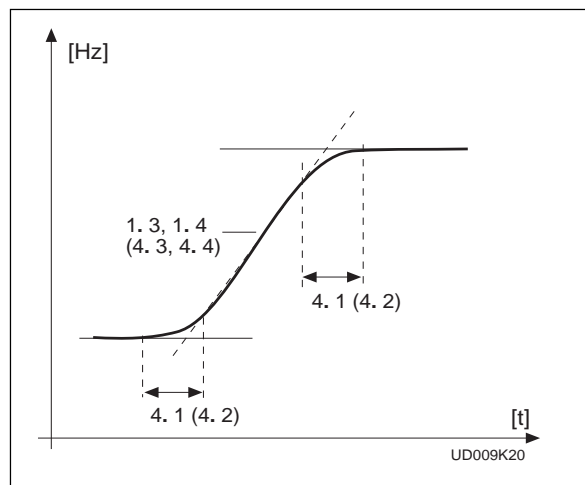

4.3 Acceleration time 2**4.4 Deceleration time 2**

These values correspond to the time required for the output frequency to accelerate from the set minimum frequency (par. 1. 1) to the set maximum frequency (par. 1. 2). These times give the possibility to set two different acceleration/ deceleration time sets for one application. The active set can be selected with the programmable signal DIA3 of this application, see parameter 2. 2.

Acceleration/deceleration times can be reduced with an external free analogue input signal, see parameters 2. 18 and 2. 19.

4.5 Brake chopper

0 = No brake chopper

1 = Brake chopper and brake resistor installed

2 = External brake chopper

When the frequency converter is decelerating the motor, the inertia of the motor and the load are fed into the external brake resistor. This enables the frequency converter to decelerate the load with the torque equal to that of acceleration, if the brake resistor is selected correctly. See separate Brake resistor installation manual.

4.6 Start function

Ramp:

- 0** The frequency converter starts from 0 Hz and accelerates to the set reference frequency within the set acceleration time. (Load inertia or starting friction may cause prolonged acceleration times).

Flying start:

- 1** The frequency converter is able to start into running motor by applying a small torque to motor and searching for frequency corresponding to the speed the motor is running at. Searching starts from the maximum frequency towards the actual frequency until the correct value is detected. Thereafter the output frequency will be accelerated/decelerated to the set reference value according to the set acceleration/deceleration parameters.

Use this mode if the motor is coasting when the start command is given.

With the flying start it is possible to ride through short mains voltage interruptions.

4.7 Stop function

Coasting:

- 0** The motor coasts to a halt without any control from the frequency converter, after the Stop command.

Ramp:

- 1** After the Stop command, the speed of the motor is decelerated according to the set deceleration parameters.

If the regenerated energy is high it may be necessary to use an external braking resistor for faster deceleration.

4.8 DC braking current

Defines the current injected into the motor during the DC braking.

4.9 DC braking time at stop

Defines if braking is ON or OFF and the braking time of the DC-brake when the motor is stopping. The function of the DC-brake depends on the stop function, parameter 4.7. See figure 6-21.

- 0** DC-brake is not used
- >0** DC-brake is in use and its function depends on the Stop function, (param. 4.7), and the time depends on the value of parameter 4.9:

Stop-function = 0 (coasting):

After the stop command, the motor coast to a stop without any control from the frequency converter.

With DC-injection, the motor can be electrically stopped in the shortest possible time, without using an optional external braking resistor.

The braking time is scaled according to the frequency when the DC-braking starts. If the frequency is \geq nominal frequency of the motor (par. 1.11), setting value of parameter 4.9 determines the braking time. When the frequency is $\leq 10\%$ of the nominal, the braking time is 10% of the set value of parameter 4.9.

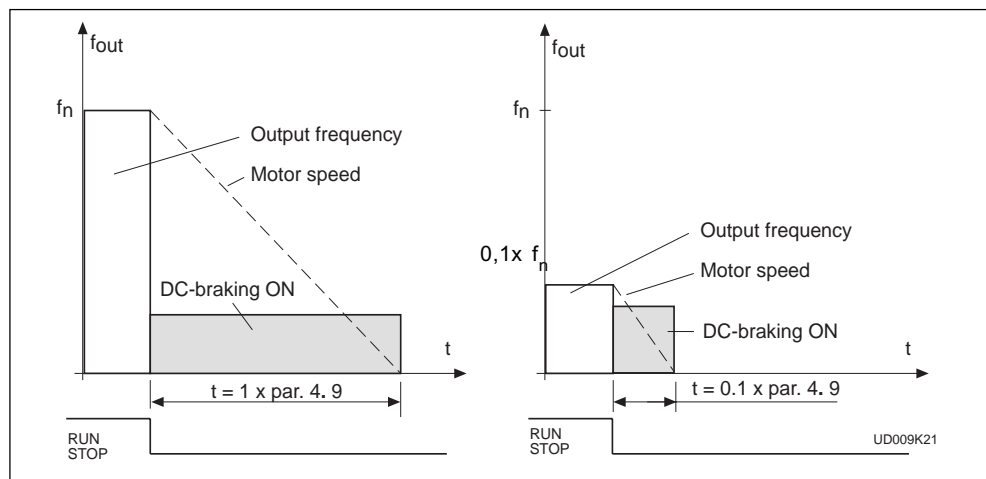

Figure 6-21 DC-braking time when stop = coasting.

Stop-function = 1 (ramp):

After the Stop command, the speed of the motor is reduced according to the set deceleration parameters, as fast as possible, to a speed defined with the parameter 4.10, where the DC-braking starts.

The braking time is defined with parameter 4.9. If high inertia exists, it is recommended to use an external braking resistor for faster deceleration. See figure 6-22.

Figure 6-22 DC-braking time when stop function = ramp.

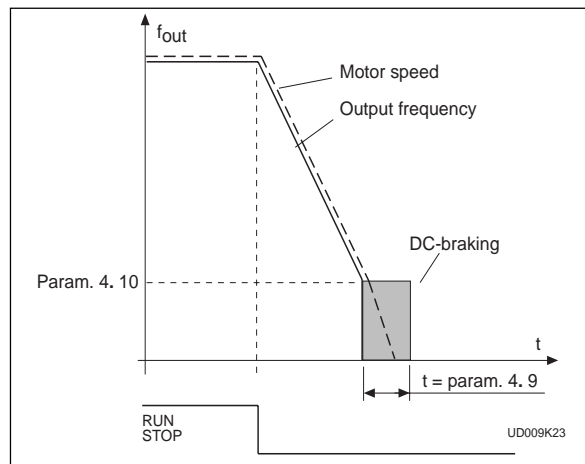

4. 10 Execute frequency of DC-brake during ramp Stop

See figure 6-22.

4. 11 DC-brake time at start

- 0** DC-brake is not used
- >0** DC-brake is activated when the start command is given and this parameter defines the time before the brake is released. After the brake is released, the output frequency increases according to the set start function parameter 4. 6 and acceleration parameters (1. 3, 4. 1 or 4. 2, 4. 3), see figure 6-23.

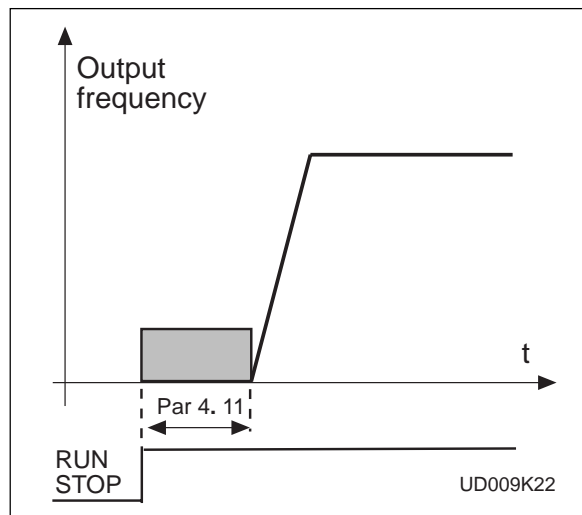

Figure 6-23 DC-braking at start

4. 12 - 4. 18 Multi-Step speed references 1-7

Parameter value defines the Multi-Step speeds selected with the digital inputs.

- 5. 1 Prohibit frequency area**
- 5. 2 Low limit/High limit**
- 5. 3**
- 5. 4**
- 5. 5**
- 5. 6**

In some systems it may be necessary to avoid certain frequencies because of mechanical resonance problems. With these parameters it is possible to set limits for three "skip frequency" regions.

Figure 6-24 Example of prohibit frequency area setting.

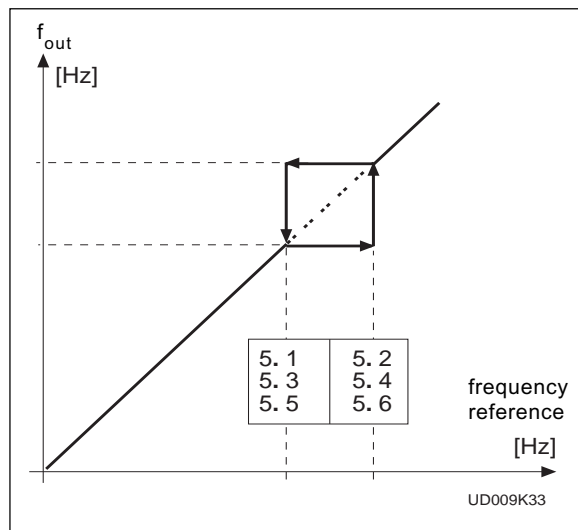

6. 1 Motor control mode

- 0 = Frequency control: The I/O terminal and panel references are frequency references and the frequency converter controls the output frequency (output frequency resolution = 0.01 Hz)
- 1 = Speed control: The I/O terminal and panel references are speed references and the frequency converter controls the motor speed (regulation accuracy $\pm 0,5\%$).
- 2 = Torque control: The I/O terminal and panel references are torque references and the frequency converter controls the motor torque (regulation accuracy $\pm 3\%$; proper tuning required: motor nameplate values, U/f -setting).

6.2 Switching frequency

Motor noise can be minimized using a high switching frequency. Increasing the switching frequency reduces the capacity of the frequency converter unit.

Before changing the frequency from the factory default 10 kHz (3.6 kHz from 30 kW upwards), check the allowed capacity from the curve in the figure 5.2-3 of chapter 5.2 of the User's Manual.

6.3 Field weakening point

6.4 Voltage at the field weakening point

The field weakening point is the output frequency at which the output voltage reaches the set maximum value (par. 6. 4). Above that frequency the output voltage remains at the set maximum value.

Below that frequency the output voltage depends on the setting of the U/f curve parameters 1. 8, 1. 9, 6. 5, 6. 6 and 6. 7. See figure 6-25.

When the parameters 1. 10 and 1. 11, nominal voltage and nominal frequency of the motor, are set, also parameters 6. 3 and 6. 4 are set automatically to the corresponding values. If different values for the field weakening point and the maximum output voltage are required, change these parameters after setting the parameters 1. 10 and 1. 11.

6.5 U/f curve, middle point frequency

If the programmable U/f curve has been selected with the parameter 1. 8 this parameter defines the middle point frequency of the curve. See figure 6-25.

6.6 U/f curve, middle point voltage

If the programmable U/f curve has been selected with the parameter 1. 8 this parameter defines the middle point voltage of the curve. See figure 6-25.

6.7 Output voltage at zero frequency

If the programmable U/f curve has been selected with the parameter 1. 8 this parameter defines the zero frequency voltage of the curve. See figure 6-25.

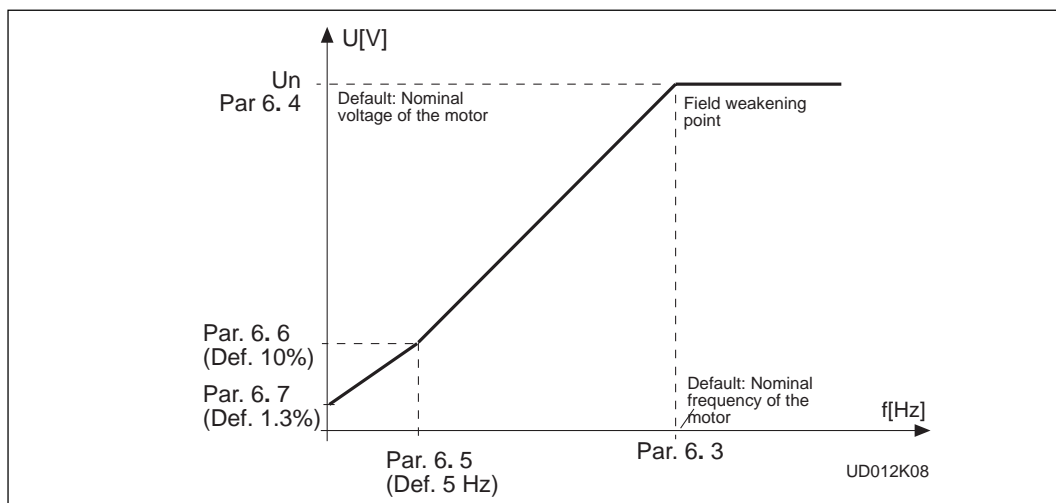

Figure 6-25 Programmable U/f curve.

6.8 Overvoltage controller**6.9 Undervoltage controller**

These parameters allow the over/undervoltage controllers to be switched out of operation. This may be useful, for example, if the mains supply voltage varies more than -15%—+10% and the application will not tolerate this over-/undervoltage, the regulator controls the output frequency according to the supply fluctuations. Over/undervoltage trips may occur when controllers are switched out of operation.

7.1 Response to the reference fault

0 = No response

1 = Warning

2 = Fault, stop mode after fault according to parameter 4.7

3 = Fault, stop mode after fault always by coasting

A warning or a fault action and message is generated if 4—20 mA reference signal is used and the signal falls below 4 mA. The information can also be programmed via digital output DO1 and via relay outputs RO1 and RO2.

7.2 Response to external fault

0 = No response

1 = Warning

2 = Fault, stop mode after fault according to parameter 4.7

3 = Fault, stop mode after fault always by coasting

A warning or a fault action and message is generated from the external fault signal in the digital input DIA3. The information can also be programmed into digital output DO1 and into relay outputs RO1 and RO2.

7.3 Phase supervision of the motor

0 = No action

1 = Warning

2 = Fault

Phase supervision of the motor ensures that the motor phases have approximately equal current.

7.4 Earth fault protection

0 = No action

1 = Warning

2 = Fault

Earth fault protection ensures that the sum of the motor phase currents is zero.

The overcurrent protection is always working and protects the frequency converter from earth faults with high currents.

Parameters 7.5—7.9 Motor thermal protection**General**

Motor thermal protection is to protect the motor from overheating. Vacon CX/CXL/CXS drive is capable of supplying higher than nominal current to the motor. If the load requires this high current there is a risk that motor will be thermally overloaded. This is true especially at low frequencies. At low frequencies the cooling effect of the motor is reduced as well as is the capacity of the motor. If the motor is equipped with an external fan the load reduction on low speeds is small.

Motor thermal protection is based on a calculated model and it uses the output current of the drive to determine the load on the motor. When the power of the drive is turned on, the calculated model uses the heatsink temperature to determine the initial thermal stage for the motor. The calculated model assumes that the ambient temperature of the motor is 40°C.

Motor thermal protection can be adjusted by setting the parameters. The thermal current I_T specifies the load current above which the motor is overloaded. This current limit is a function of the output frequency. The curve for I_T is set with parameters 7. 6, 7. 7 and 7. 9, refer to the figure 6-26. The parameters have their default values taken from the motor name plate data.

With the output current at I_T the thermal stage will reach the nominal value (100%). The thermal stage changes by the square of the current. With output current at 75% from I_T the thermal stage will reach 56% value and with output current at 120% from I_T the thermal stage would reach 144% value. The function will trip the device (refer par. 7. 5) if the thermal stage will reach a value of 105%. The speed of change in thermal stage is determined with the time constant parameter 7. 8. The bigger the motor the longer it takes to reach the final temperature.

The thermal stage of the motor can be monitored through the display. Refer to the table for monitoring items. (User's Manual, table 7.3-1).



CAUTION!

The calculated model does not protect the motor if the airflow to the motor is reduced by blocked air intake grill.

7. 5 Motor thermal protection

Operation:

0 = Not in use

1 = Warning

2 = Trip function

Tripping and warning will display the same message code. If tripping is selected the drive will stop and activate the fault stage.

Deactivating the protection, setting parameter to 0, will reset the thermal stage of the motor to 0%.

7. 6 Motor thermal protection, break point current

The current can be set between 50.0—150.0% x I_{nMotor} .

This parameter sets the value for thermal current at frequencies above the break point on the thermal current curve. Refer to the figure 6-26.

The value is set in percentage which refers to the name plate data of the motor, parameter 1. 13, nominal current of the motor, not the drive's nominal output current.

The motor's nominal current is the current which the motor can withstand in direct on-line use without being overheated.

If parameter 1. 13 is adjusted, this parameter is automatically restored to the default value.

Setting this parameter (or parameter 1. 13) does not affect the maximum output current of the drive. Parameter 1. 7 alone determines the maximum output current of the drive.

Figure 6-26 Motor thermal current I_T curve.

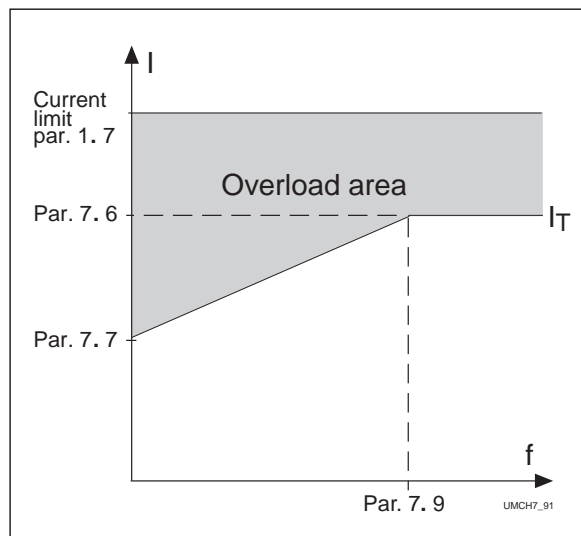

7.7 Motor thermal protection, zero frequency current

The current can be set between 10.0—150.0% $\times I_{nMotor}$. This parameter sets the value for thermal current at zero frequency. Refer to figure 6-26.

The default value is set assuming that there is no external fan cooling the motor. If an external fan is used this parameter can be set to 90% (or even higher).

The value is set as a percentage of the motor name plate data, parameter 1. 13, motor's nominal current, not the drive's nominal output current. Motor's nominal current is the current which the motor can stand in direct on-line use without being overheated.

If you change the parameter 1. 13 this parameter is automatically restored to the default value.

Setting this parameter (or parameter 1. 13) does not affect to the maximum output current of the drive. Parameter 1. 7 alone determines the maximum output current of the drive.

7.8 Motor thermal protection, time constant

This time can be set between 0.5—300 minutes.

This is the thermal time constant of the motor. The bigger the motor the bigger the time constant. The time constant is the time within which the calculated thermal stage has reached 63% of its final value.

The motor thermal time is specific for the motor design and it varies between different motor manufacturers.

The default value for the time constant is calculated basing on the motor name plate data given with parameters 1. 12 and 1. 13. If either of these parameters is set, this parameter is set to default value.

If the motor's t_6 -time is known (given by the motor manufacturer) the time constant

parameter could be set basing on t_6 -time. As a rule of thumb, the motor thermal time constant in minutes equals to $2 \times t_6$ (t_6 in seconds is the time a motor can safely operate at six times the rated current). If the drive is in stop stage the time constant is internally increased to three times the set parameter value. The cooling in the stop stage is based on convection and the time constant is increased.

7.9 Motor thermal protection, breakpoint frequency

The frequency can be set between 10—500 Hz.

This is the breakpoint of thermal current curve. With frequencies above this point the thermal capacity of the motor is assumed to be constant. Refer to the figure 6-26.

The default value is based on the motor's name plate data, parameter 1. 11. It is 35 Hz for a 50 Hz motor and 42 Hz for a 60 Hz motor. More generally it is 70% of the frequency at field weakening point (parameter 6. 3). Changing either parameter 1. 11 or 6. 3 will restore this parameter to its default value.

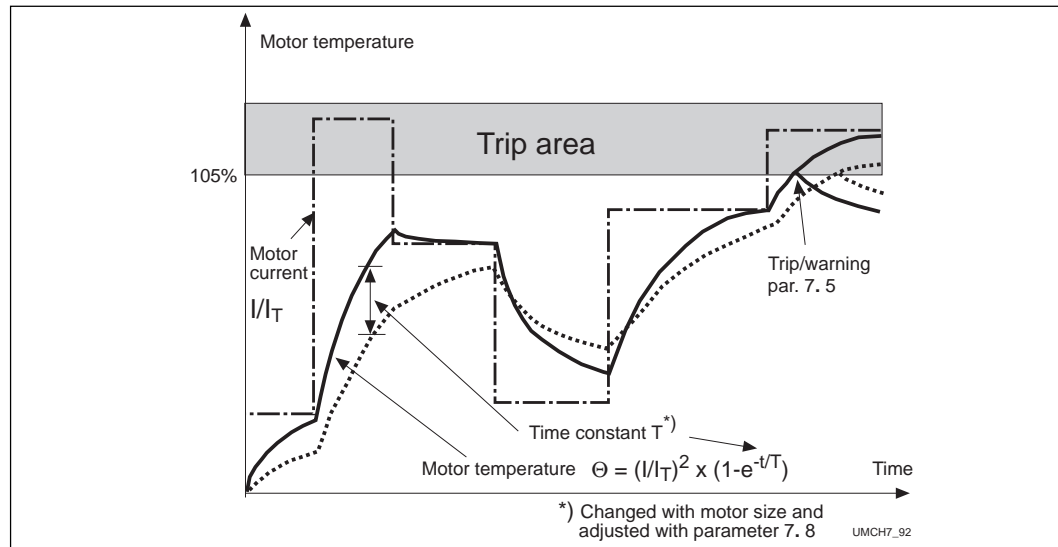

Figure 6-27 Calculating motor temperature.

Parameters 7. 10— 7. 13, Stall protection

General

Motor stall protection protects the motor from short time overload situations like a stalled shaft. The reaction time of stall protection can be set shorter than with motor thermal protection. The stall state is defined with two parameters, 7.11. Stall Current and 7.13. Stall Frequency. If the current is higher than the set limit and output frequency is lower than the set limit, the stall state is true. There is actually no real indication of the shaft rotation. Stall protection is a type of overcurrent protection.

7. 10 Stall protection

Operation:

0 = Not in use

1 = Warning

2 = Trip function

Tripping and warning will display the same message code. If tripping is set on, the drive will stop and activate the fault stage.

Setting the parameter to 0 will deactivate the protection and will reset the stall time counter to zero.

7. 11 Stall current limit

The current can be set to 0.0—200% x I_{nMotor} . In a stall stage the current has to be above this limit. Refer to figure 6-28. The value is set as a percentage of the motor's name plate data, parameter 1. 13, motor's nominal current. If parameter 1.13 is adjusted, this parameter is automatically restored to the default value.

Figure 6-28 Setting the stall characteristics.

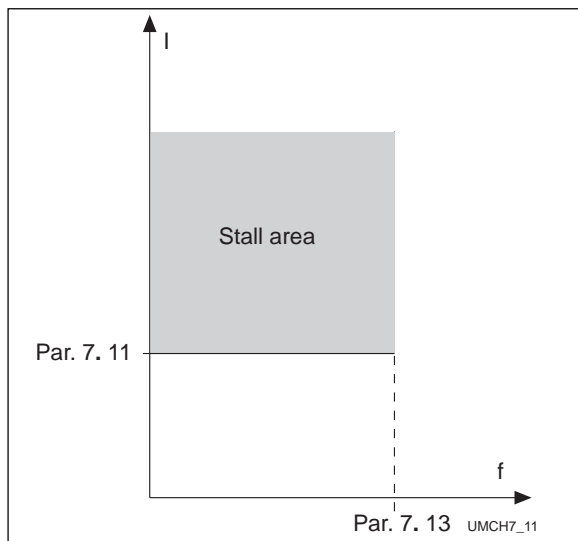

7. 12 Stall time

The time can be set between 2.0—120 s. This is the maximum allowed time for a stall stage. There is an internal up/down counter to count the stall time. Refer to figure 6-29. If the stall time counter value goes above this limit the protection will cause a trip (refer to parameter 7. 10).

7. 13 Maximum stall frequency

The frequency can be set between 1— f_{max} (par. 1. 2). In a stall state, the output frequency has to be smaller than this limit. Refer to figure 6-28.

Figure 6-29 Counting the stall time.

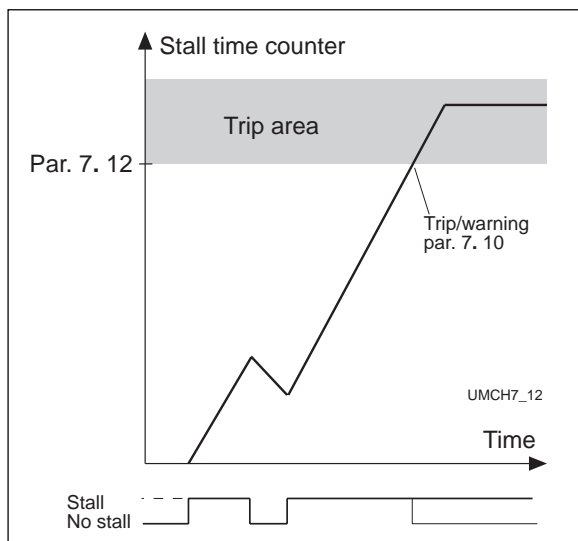

Parameters 7. 14— 7. 17, Underload protection General

The purpose of motor underload protection is to ensure that there is load on the motor when the drive is running. If the motor loses its load there might be a problem in the process, e.g. a broken belt or dry pump.

Motor underload protection can be adjusted by setting the underload curve with parameters 7. 15 and 7. 16. The underload curve is a squared curve set between zero frequency and the field

weakening point. The protection is not active below 5Hz (the underload counter value is stopped). Refer to figure 6-30.

The torque values for setting the underload curve are set in percentage which refer to the nominal torque of the motor. The motor's name plate data, parameter 1. 13, the motor's nominal current and

the drive's nominal current I_{CT} are used to find the scaling ratio for the internal torque value. If other than nominal motor is used with the drive, the accuracy of the torque calculation decreases.

7. 14 Underload protection

Operation:

- 0 = Not in use
- 1 = Warning
- 2 = Fault

Tripping and warning will display the same message code. If tripping is set active the drive will stop and activate the fault stage.

Deactivating the protection by setting the parameter to 0 will reset the underload time counter to zero.

7. 15 Underload protection, field weakening area load

The torque limit can be set between 20.0—150 % $\times T_{nMotor}$.

This parameter gives the value for the minimum torque allowed when the output frequency is above the field weakening point.

Refer to figure 4.5-22.

If parameter 1. 13 is adjusted, this parameter is automatically restored to the default value.

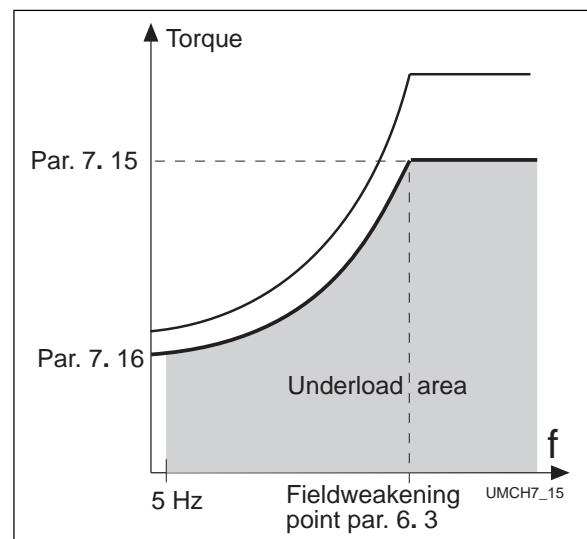

Figure 6-30 Setting of minimum load.

7. 16 Underload protection, zero frequency load

The torque limit can be set between 10.0—150 % $\times T_{nMotor}$.

This parameter gives value for the minimum torque allowed with zero frequency. Refer to figure 6-30. If parameter 1. 13 is adjusted this parameter is automatically restored to the default value.

7. 17 Underload time

This time can be set between 2.0—600.0 s.

This is the maximum allowed time for an underload state. There is an internal up/down counter to accumulate the underload time. Refer to figure 6-31.

If the underload counter value goes above this limit the protection will cause a trip (refer to the parameter 7. 14). If the drive is stopped the underload counter is reset to zero.

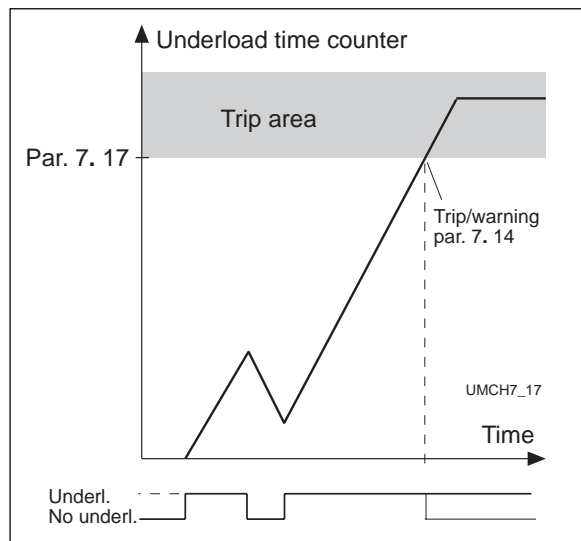

Figure 6-31 Counting the underload time.

7. 18 Phase supervision of the supply voltage

0 = No action

1 = Warning

2 = Fault

By setting the parameter value to zero, the phase supervision of the supply voltage will not cause tripping

7. 19 Thermistor input of IO-Expander

0 = No action

1 = Warning

2 = Fault

The thermistor connected to the thermistor input of the I/O-expander board supervises the temperature of the motor. With parameter 7.19 the response of the frequency converter can be programmed when the thermistor indicates overtemperature.

7. 20 Response to the fieldbus fault

0 = No response

1 = Warning message

2 = Fault message, stop mode after fault according to parameter 4.7

A warning or a fault action and message is generated from the fieldbus card if the error occurs of the bus system physical layer.

8. 1 Automatic restart: number of tries

8. 2 Automatic restart: trial time

The Automatic restart function restarts the frequency converter after the faults selected with parameters 8. 4—8. 8. The Start function for Automatic restart is selected with parameter 8. 3.

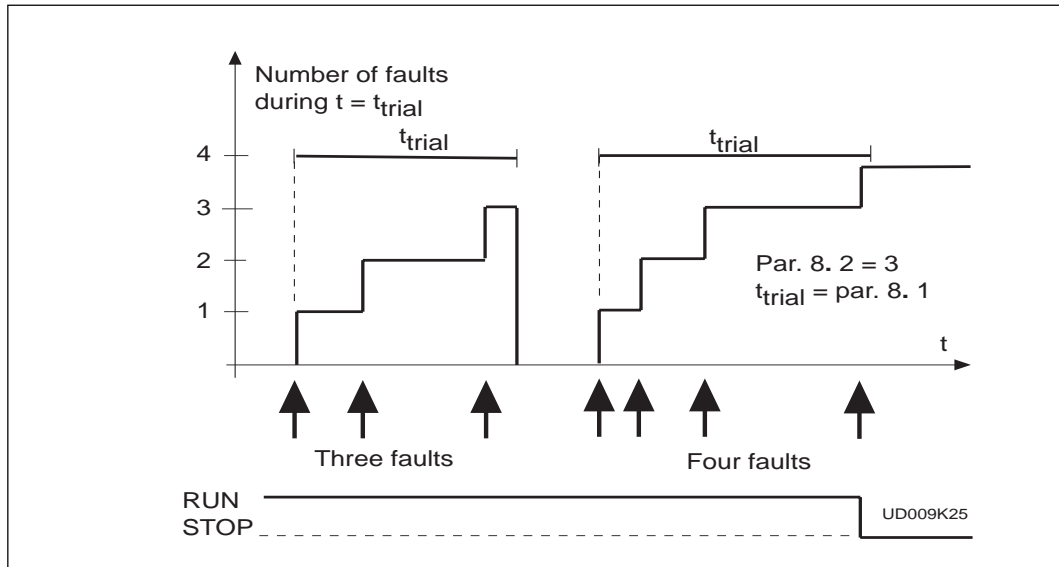

Figure 6-32 Automatic restart

Parameter 8. 1 determines how many automatic restarts can be made during the trial time set by the parameter 8. 2.

The time counting starts from the first autorestart. If the number of restarts does not exceed the value of the parameter 8. 1 during the trial time, the counting is cleared after the time is elapsed and next fault starts the counting again.

8. 3 Automatic restart, start function

The parameter defines the start mode:

- 0 = Start with ramp
- 1 = Flying start, see parameter 4. 6.

8. 4 Automatic restart after undervoltage trip

- 0 = No automatic restart after undervoltage fault trip
- 1 = Automatic restart after undervoltage fault condition returns to normal condition (DC-link voltage returns to the normal level)

8. 5 Automatic restart after overvoltage trip

- 0 = No automatic restart after overvoltage fault trip
- 1 = Automatic restart after overvoltage fault condition returns to the normal condition (DC-link voltage returns to the normal level)

8. 6 Automatic restart after overcurrent trip

- 0 = No automatic restart after overcurrent fault trip
- 1 = Automatic restart after overcurrent faults

8. 7 Automatic restart after reference fault trip

- 0 = No automatic restart after reference fault trip
- 1 = Automatic restart after analog current reference signal (4—20 mA) returns to the normal level (≥ 4 mA)

8. 8 Automatic restart after over-/undertemperature fault trip

- 0 = No automatic restart after temperature fault trip
- 1 = Automatic restart after heatsink temperature has returned to its normal level between -10°C — $+75^{\circ}\text{C}$.

Torque control

Torque control can be activated either by setting parameter 6.1 to torque control or with digital input DIA3 (parameter 2.2=10). Torque reference source is selected with parameter 9.1 and reference scaling with parameters 9.2 and 9.3.

9.1 Torque reference selection

Defines the source for torque reference value:

0 = None

1 = U_{in}

2 = I_{in}

3 = Panel torque reference r2

4 = Ain1 (option board)

5 = Ain2 (option board)

6 = Fieldbus control

9.2 Torque reference scaling bias

9.3 Torque reference scaling gain

The additional scaling function can be used for scaling the torque reference. The torque reference is always fed to the torque controller even if it is not activated.

$$T_{ref. out} = gain \times T_{ref. in} + bias$$

9.4 TC time constant

Defines the time constant for the torque controller. A short time constant means fast response.

9.5 TC min. control limit

Defines frequency limit below which the frequency converter operates normally in frequency control mode.

The internal torque calculation is inaccurate at low speeds (< nominal slip of the motor). It is recommended to operate in frequency control operation mode at low speeds.

The reference value in frequency controlled operation mode is selected with parameter 1. 5.

Fieldbus control

Fieldbus control can be activated with parameter 10.1. Then the frequency or speed reference comes from the fieldbus as well as the Start/Stop and Reverse control.

First two parameters in group 10 concern all fieldbuses. Parameters 10.3 - 10.6 are only for Modbus, parameters 10.7 - 10.13 only for Profibus and 10.14 only for LonWorks.

10.1 Fieldbus control

Defines the active control source:

- 0:** control via I/O terminals
- 1:** control via Fieldbus board

10.2 DIC1 function

- 0:** Fieldbus control, contact open = Active control source are I/O terminals
contact closed = Active control source is the Fieldbus board
- 1:** External Fault, closing contact = Fault is shown and motor is stopped when the input is active

Parameters 10.3 - 10.6 only for Modbus protocol

10.3 Slave address

Defines slave device address. Maximum value for this parameter is 247 and minimum is 1.

10.4 Baud Rate

- 1:** 300 baud
- 2:** 600 baud
- 3:** 1200 baud
- 4:** 2400 baud
- 5:** 4800 baud
- 6:** 9600 baud
- 7:** 19200 baud

10.5 Parity type

- 0:** None
- 1:** Even
- 2:** Odd

10.6 Modbus time-out

The Modbus time-out determines how long the Fieldbus board waits for a message from a master device and is specified in seconds. Time can be set between 0 - 3600 s. Time 0 s = No time-out

Parameters 10.7 to 10.13 only for Profibus DP protocol

10.7 Profibus slave address

Defines slave device address. Maximum value for this parameter is 126 and minimum 2.

10.8 Profibus baud rate

1:	9.6	kbaud
2:	19.2	kbaud
3:	93.75	kbaud
4:	187.5	kbaud
5:	500	kbaud
6:	1.5	Mbaud
7:	3	Mbaud
8:	6	Mbaud
9:	12	Mbaud
10:	AUTO	(Automatic baud rate select)

10.9 Profibus PPO Type

Selection of profibus PPO type.

1:	PPO 1	(Parameter data 8 bytes, Control data 4 bytes)
2:	PPO 2	(Parameter data 8 bytes, Control data 12 bytes)
3:	PPO 3	(Control data 4 bytes)
4:	PPO 4	(Control data 12 bytes)

10.10 Profibus process Data 1**10.11 Profibus process Data 2****10.12 Profibus process Data 3****10.13 Profibus process Data 4**

Selection of profibus process data source.

Value 1...22 Number of actual value (= V1...V22 in Monitoring Menu)
99 Active fault code

Parameter 10.14 only for LonWorks protocol**10.14 LonWorks service button**

Changing the value of this parameter from 0 to 1 or vice versa and pressing the Enter button causes the unique LonWorks ID number to be sent to the network.

7 FAULT CODE

The Multipurpose Application II has an extra fault code:

Fault number	Fault	Possible cause	Checking
27	Fieldbus communication error	Fieldbus board has detected the reset or error of the Bus system (physical layer)	Reset the fault and restart again. If the fault comes again: - check the host system - check the cables

8 MONITORING DATA

The Multipurpose Application II has extra items for monitoring (V1 - V24). See table 8-1

Data number	Data name	Unit	Description
V1	Output frequency	Hz	Frequency to the motor
V2	Motor speed	rpm	Calculated motor speed
V3	Motor current	A	Measured motor current
V4	Motor torque	%	Calculated actual torque/nominal torque of the unit
V5	Motor power	%	Calculated actual power/nominal power of the unit
V6	Motor voltage	V	Calculated motor voltage
V7	DC-link voltage	V	Measured DC-link voltage
V8	Temperature	°C	Temperature of the heat sink
V9	Operating day counter	DD.dd	Operating days ¹⁾ , not resettable
V10	Operating hours, "trip counter"	HH.hh	Operating hours ²⁾ , can be reset with programmable button #3
V11	MW-hours	MWh	Total MW-hours, not resettable
V12	MW-hours, "trip counter"	MWh	MW-hours, can be reset with programmable button #4
V13	Voltage/analogue input	V	Voltage of the terminal U _{in+} (term. #2)
V14	Current/analogue input	mA	Current of terminals I _{in+} and I _{in-} (term. #4, #5)
V15	Digital input status, gr. A		
V16	Digital input status, gr. B		
V17	Digital and relay output status		
V18	Control program		Version number of the control software
V19	Unit nominal power	kW	Shows the power size of the unit
V20	Motor temperature rise	%	100%= temperature of motor has risen to nominal
V21	Reference frequency	Hz	Frequency reference
V22	Torque reference	%	Torque reference when torque control in use
V23	Digital inputs (opt. board)		
V24	Fieldbus status		Used with Profibus option board only. 0 = Master-Slave communication not started 1 = Master-Slave communication is starting up 2 = Master-Slave communication started and OK.

¹⁾ DD = full days, dd = decimal part of a day

²⁾ HH = full hours, hh = decimal part of an hour

Table 8-1 Monitoring items

Ud00182d
09.10.2000

Author: Jaana Kukkonen
email: jaana.kukkonen@vacon.com
fax: +358-(0)201-212 205
phone: +358-(0)201-212 331



Vacon Plc
P.O.Box 25
Runsorintie 7
65381 VAASA
FINLAND
Tel: +358-(0)201-2121
Fax: +358-(0)201-212 205
Service: +358-40-8371 150
E-mail: vacon@vacon.com