

Motion Controller

**GM1 Series**

# Reference Manual

---

Analog I/O Unit Edition

[Applicable models]

AGM1AD8

AGM1DA4

(MEMO)

## Introduction

Thank you for purchasing a Panasonic product. Before you use the product, please carefully read through the installation instructions and the manuals, and understand them in detail to use the product properly.

## Types of Manual

- There are different types of manuals for the GM1 series, as listed below. Please refer to a relevant manual for the unit and purpose of your use.
- The manuals can be downloaded from our website: <https://industrial.panasonic.com/ac/e/motor/motion-controller/mc/gm1/index.jsp>.

### Manuals for GM1 series

Manual name	Manual code	Description
GM1 Controller RTEX User's Manual (Setup Edition)	WUME-GM1RTXSU	Explains wiring between the GM1 and its peripheral devices, installation method, and operation check method.
GM1 Controller EtherCAT User's Manual (Setup Edition)	WUME-GM1ETCSU	
GM1 Controller RTEX User's Manual (Operation Edition)	WUME-GM1RTXOP	Explains how to use GM Programmer and PANATERM Lite for GM, set up each function, create projects, and perform other operations.
GM1 Controller EtherCAT User's Manual (Operation Edition)	WUME-GM1ETCOP	
GM1 Series Reference Manual (Hardware Edition)	WUME-GM1H	Explains the functions and performance of each GM1 unit.
GM1 Series Reference Manual (Instruction Edition)	WUME-GM1PGR	Explains the specifications of each instruction that can be used with the GM1 Series.
GM1 Series Reference Manual (Analog I/O Unit)	WUME-GM1AIO	Explains the functions and performance of the GM1 Analog Expansion Unit.
GM1 Series Reference Manual (Pulse Output Unit)	WUME-GM1PG	Explains the functions and performance of the GM1 Pulse Output Unit.

## Copyright / Trademarks

- The copyright of this manual is owned by **Panasonic Industry Co., Ltd.**
- Unauthorized reproduction of this manual is strictly prohibited.
- Windows is a registered trademark of Microsoft Corporation in the U.S. and other countries.
- EtherCAT is a registered trademark of and patented technology licensed by Beckhoff Automation GmbH, Germany.
- Other company and product names are trademarks or registered trademarks of their respective companies.

(MEMO)

# Table of Contents

<b>1 Before Using This Product.....</b>	<b>1-1</b>
1.1 Safety Precautions.....	1-2
1.2 Handling Precautions.....	1-3
<b>2 Outline.....</b>	<b>2-1</b>
2.1 Unit Type.....	2-2
2.1.1 Analog Input Unit .....	2-2
2.1.2 Analog Output Unit.....	2-3
2.2 Names and Functions of Components of the GM1 Analog I/O Unit ...	2-4
2.3 Restrictions on Units Combination.....	2-5
2.3.1 Applicable Versions of Unit and Software .....	2-5
2.3.2 Restriction by Power Consumption .....	2-5
<b>3 Wiring.....</b>	<b>3-1</b>
3.1 Connecting Analog Input .....	3-2
3.1.1 Precautions When Connecting Analog Signal .....	3-2
3.1.2 Terminal Layout Diagram of the GM1 Analog Input Unit.....	3-2
3.1.3 Analog Input Circuit and Wiring .....	3-2
3.2 Analog Output Connections .....	3-4
3.2.1 Precautions When Connecting Analog Signal .....	3-4
3.2.2 Terminal Layout Diagram of the GM1 Analog Output Unit.....	3-4
3.2.3 Analog Output Circuit and Wiring (For the Voltage Output) .....	3-4
3.2.4 Analog Output Circuit and Wiring (For the Current Output) .....	3-5
3.3 Wiring to the Connector .....	3-6
3.3.1 Suitable Parts and Tools .....	3-6
3.3.2 Wire Connection Method .....	3-6
<b>4 Project Creation .....</b>	<b>4-1</b>
4.1 Adding Expansion Units.....	4-2
4.2 Setting Parameters and Performing I/O Mapping.....	4-5
4.3 Setting the Analog Input Unit .....	4-7
4.3.1 List of Analog_8IN Parameters .....	4-7
4.3.2 List of Analog_8IN I/O Mapping .....	4-8
4.4 Setting the Analog Output Unit .....	4-10
4.4.1 List of Analog_4OUT Parameters .....	4-10
4.4.2 List of Analog_4OUT I/O Mapping .....	4-11
<b>5 Functions of the Analog Input Unit .....</b>	<b>5-1</b>
5.1 Basic Operation .....	5-2
5.1.1 Reading Analog Input Data.....	5-2
5.1.2 Input Setting and Conversion Processing Time .....	5-3
5.2 Average Processing Settings.....	5-5
5.2.1 Count-based Average .....	5-5
5.2.2 Time-based Average.....	5-6

5.2.3 Moving Average .....	5-6
5.3 Offset / Gain Processing Function .....	5-8
5.4 Scale Conversion Function .....	5-10
5.5 Upper Limit / Lower Limit Comparison Function .....	5-11
5.6 Max. / Min. Hold Function .....	5-14
5.7 Disconnection Detection Function .....	5-17
<b>6 Functions of the Analog Output Unit .....</b>	<b>6-1</b>
6.1 Basic Operation .....	6-2
6.1.1 Writing Analog Output Data .....	6-2
6.1.2 Timing Chart of Output Processing .....	6-3
6.2 Offset / Gain Processing Function .....	6-4
6.3 Scale Conversion Function .....	6-6
6.4 Clipping Function .....	6-7
6.5 Analog Output Hold Function in STOP Mode .....	6-9
<b>7 Conversion Characteristics of Analog Input Unit .....</b>	<b>7-1</b>
7.1 Voltage Range .....	7-2
7.1.1 Voltage Input Range: -10 to +10 V (Resolution: 1/64,000) .....	7-2
7.1.2 Voltage Input Range: 0 to +10 V (Resolution: 1/32,000) .....	7-3
7.1.3 Voltage Input Range: -5 to +5 V (Resolution: 1/64,000) .....	7-3
7.1.4 Voltage Input Range: 0 to +5 V (Resolution: 1/32,000) .....	7-4
7.1.5 Voltage Input Range: +1 to +5 V (Resolution: 1/25,600) .....	7-5
7.2 Current Range .....	7-6
7.2.1 Current Input Range: 0 to +20 mA (Resolution: 1/32,000) .....	7-6
7.2.2 Current Input Range: +4 to +20 mA (Resolution: 1/25,600) .....	7-6
<b>8 Conversion Characteristics of Analog Output .....</b>	<b>8-1</b>
8.1 Voltage Range .....	8-2
8.1.1 Voltage Output Range: -10 to +10 V (Resolution: 1/64,000) .....	8-2
8.1.2 Voltage Output Range: 0 to +10 V (Resolution: 1/32,000) .....	8-3
8.1.3 Voltage Output Range: -5 to +5 V (Resolution: 1/64,000) .....	8-3
8.1.4 Voltage Output Range: 0 to +5 V (Resolution: 1/32,000) .....	8-4
8.1.5 Voltage Output Range: +1 to +5 V (Resolution: 1/25,600) .....	8-4
8.2 Current Range .....	8-6
8.2.1 Current Output Range: 0 to +20 mA (Resolution: 1/32,000) .....	8-6
8.2.2 Current Output Range: +4 to +20 mA (Resolution: 1/25,600) .....	8-6
<b>9 What to Do If an Error Occurs .....</b>	<b>9-1</b>
9.1 What to Do If an Error Occurs (Analog Input) .....	9-2
9.1.1 Failure in Reading Analog Input Data .....	9-2
9.1.2 Unstable Analog Input Values .....	9-2
9.1.3 No Proper Conversion Values Obtained with Current Input .....	9-2
9.2 What to Do If an Error Occurs (Analog Output) .....	9-3
9.2.1 Unstable Analog Output Value .....	9-3
9.2.2 Unchanged Analog Output Value .....	9-3

<b>10 Specifications</b> .....	<b>10-1</b>
10.1 General Specifications .....	10-2
10.2 Performance Specifications .....	10-3
10.2.1 Input Specifications of the Analog Input Unit .....	10-3
10.2.2 Output Specifications of the Analog Output Unit.....	10-4
10.3 Dimensions .....	10-6
10.3.1 Analog I/O Unit.....	10-6
<b>Appendix Warranty / Cautions for Proper Use</b> .....	<b>App-1</b>
Warranty .....	App-2
Warranty Period .....	App-2
Warranty Scope .....	App-2
Cautions for Proper Use .....	App-3

(MEMO)



# 1 Before Using This Product

---



1.1 Safety Precautions.....	1-2
1.2 Handling Precautions.....	1-3



## 1.1 Safety Precautions





### 1.1 Safety Precautions









This section explains important rules that must be observed to prevent personal injury and property damage.

- Injuries and damages that may occur as a result of incorrect use are classified into the following levels and safety precautions are explained according to the level.

 <b>WARNING</b>	Indicates that there is a risk of death or serious injury
 <b>CAUTION</b>	Indicates that there is a risk of minor injury or property damage





	Indicates an action that is prohibited
	Indicates an action that must be taken

 <b>WARNING</b>	
	<ul style="list-style-type: none"> <li>• Take safety measures outside this product to ensure the safety of the entire system even if this product fails or an error occurs due to external factors.</li> </ul>
	<ul style="list-style-type: none"> <li>• Do not use this product in atmospheres that contain flammable gases. Doing so may result in explosion.</li> </ul>
	<ul style="list-style-type: none"> <li>• Do not throw this product into the fire. Doing so may cause the batteries or other electronic parts to explode.</li> </ul>

 <b>CAUTION</b>	
	<ul style="list-style-type: none"> <li>• To prevent abnormal heat generation or smoke generation, use this product with some leeway from the guaranteed characteristics and performance values of the product.</li> </ul>
	<ul style="list-style-type: none"> <li>• Do not disassemble or modify this product. Doing so may result in abnormal heat generation or smoke generation.</li> </ul>
	<ul style="list-style-type: none"> <li>• Do not touch any terminals while the power is on. Doing so may result in electrical shock.</li> </ul>
	<ul style="list-style-type: none"> <li>• Configure emergency stop and interlock circuits outside this product.</li> </ul>
	<ul style="list-style-type: none"> <li>• Connect wires and connectors properly. Failure to do so may result in abnormal heat generation or smoke generation.</li> </ul>
	<ul style="list-style-type: none"> <li>• Do not perform work (such as connection or removal) with the power turned on. Doing so may result in electrical shock.</li> </ul>
	<ul style="list-style-type: none"> <li>• If this product is used in any way that is not specified by Panasonic, its protection function may be impaired.</li> </ul>
	<ul style="list-style-type: none"> <li>• This product has been developed and manufactured for industrial use only.</li> </ul>

## 1.2 Handling Precautions

- In this manual, the following symbols are used to indicate safety information that must be observed.

	Indicates an action that is prohibited or a matter that requires caution.
	Indicates an action that must be taken.
 <b>Info.</b>	Indicates supplemental information.
 <b>Note</b>	Indicates details about the subject in question or information useful to remember.
 <b>Procedure</b>	Indicates operation procedures.

(MEMO)

## 2 Outline

---

2.1 Unit Type.....	2-2
2.1.1 Analog Input Unit .....	2-2
2.1.2 Analog Output Unit.....	2-3
2.2 Names and Functions of Components of the GM1 Analog I/O Unit ...	2-4
2.3 Restrictions on Units Combination.....	2-5
2.3.1 Applicable Versions of Unit and Software .....	2-5
2.3.2 Restriction by Power Consumption .....	2-5

## 2.1 Unit Type

### 2.1 Unit Type

Name	Specifications	Product No.
GM1 Analog Input Unit	Input 8ch	AGM1AD8
GM1 Analog Output Unit	Output 4ch	AGM1DA4

#### 2.1.1 Analog Input Unit

##### ■ Features of the Analog Input Unit

The analog input unit receives various analog values (i.e., voltage, current, and temperature values) from laser analog sensors and pressure sensors and converts them internally into digital values.

- The number of channels is eight.
- The input range can be selected from the following seven types.  
Voltage input: -10 to +10 V, 0 to +10 V, -5 to +5 V, 0 to +5 V, +1 to +5 V  
Current input: 0 to +20 mA, +4 to +20 mA
- The analog conversion speed is 50 µs/channel.
- The resolution is 1/25,600 to 1/64,000.  
Input analog signals are converted into a maximum of 16-bit digital data.

##### ■ Optional Functions

This product is provided with the following option setting functions.

Function	Specifications
Average processing settings function	Selects average processing for the analog values taken in by sampling.
Offset / Gain processing function	Performs the correction of offset values (addition correction) or gain values (magnification correction).
Scale conversion function	This function is to scale-convert values to an easy-to-use data range.
Upper limit / lower limit comparison function	This function compares acquired analog input data with the preset upper limit and lower limit.
Max. / Min. hold function	This function maintains the maximum and minimum values of acquired data.
Disconnection detection function	Turns ON the disconnection detection status when input is disconnected or unconnected, and warns of the error state.

## 2.1.2 Analog Output Unit

### ■ Features of the Analog Output Unit

The analog output unit converts its internal data into analog values to be output to inverters or other analog-driven equipment.

- The number of channels is four.
- The output range can be selected from the following seven types.
  - Voltage output: -10 to +10 V, 0 to +10 V, -5 to +5 V, 0 to +5 V, +1 to +5 V
  - Current output: 0 to +20 mA, +4 to +20 mA
- The digital conversion processing speed is 50  $\mu$ s.
- The resolution is 1/25,600 to 1/ 64,000.
  - Digital values set for conversion are converted into a maximum of 16-bit analog data.

### ■ Optional Functions

This product is provided with the following option setting functions.

Function	Specifications
Offset / Gain processing function	Performs the correction of offset values (addition correction) or gain values (magnification correction).
Scale conversion function	This function is to scale-convert values to an easy-to-use analog output range.
Clipping function	Sets in advance the upper limit and lower limit for the analog output value.
Analog output hold function in STOP mode	Holds the analog output when the operation mode of the GM1 Controller changes from RUN to STOP.

## 2.2 Names and Functions of Components of the GM1 Analog I/O Unit

### 2.2 Names and Functions of Components of the GM1 Analog I/O Unit

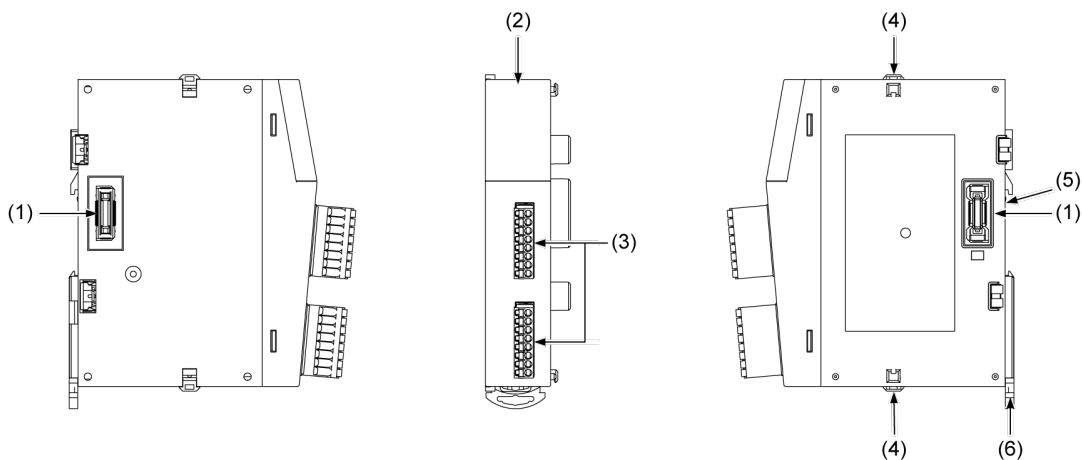

No.	Name	Function
(1)	Unit connector	This is a connector to which each expansion unit is connected.
(2)	Operation monitor LEDs	These LEDs indicate the status of expansion units.
(3)	I/O connector	Used to connect input devices or output devices.
(4)	Expansion hook	This is a hook used to fix each expansion unit to another.
(5)	DIN rail attachment part	This is the part which is attached to the DIN rail.
(6)	DIN hook	Used to fix the Controller to a DIN rail

#### ■ Names and functions of each operation monitor LED

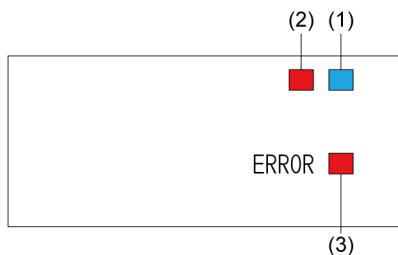

No.	Name	LED color	Function
(1)	Power	Blue	Indicates the completion of power processing of the unit. Lit: Power supply of the unit is started normally. Unlit: Power is not supplied. Or, there is an error in the power supply to the system.
(2)	Alarm	Red	Indicates that an alarm has occurred in the unit. Lit: Unit error Unlit: Normal
(3)	ERROR	Red	Indicates that an error has occurred in the unit. Lit: Error occurred. Unlit: Normal



## 2.3 Restrictions on Units Combination

### 2.3.1 Applicable Versions of Unit and Software

For using the GM1 Analog I/O Unit, the GM1 Controller and GM Programmer with the following versions are required.

Name		Applicable version
RTEX-compatible GM1 Controller (Sink type)	AGM1CSRX16T	Ver.1.2.0.0 or later
EtherCAT-compatible GM1 Controller (Sink type)	AGM1CSEC16T	Ver.1.2.0.0 or later
EtherCAT-compatible GM1 Controller (Source type)	AGM1CSEC16P	
GM Programmer		Ver.1.2.0.0 or later

### 2.3.2 Restriction by Power Consumption

The unit has the following internal current consumption. Make sure that the total current consumption is within the capacity of the power supply with consideration of all other units used in combination with this unit.

Name	Product No.	Consumption current
GM1 Analog Input Unit	AGM1AD8	130 mA or less
GM1 Analog Output Unit	AGM1DA4	160 mA or less

(MEMO)

# 3 Wiring

---

3.1	Connecting Analog Input .....	3-2
3.1.1	Precautions When Connecting Analog Signal .....	3-2
3.1.2	Terminal Layout Diagram of the GM1 Analog Input Unit.....	3-2
3.1.3	Analog Input Circuit and Wiring .....	3-2
3.2	Analog Output Connections .....	3-4
3.2.1	Precautions When Connecting Analog Signal .....	3-4
3.2.2	Terminal Layout Diagram of the GM1 Analog Output Unit.....	3-4
3.2.3	Analog Output Circuit and Wiring (For the Voltage Output) .....	3-4
3.2.4	Analog Output Circuit and Wiring (For the Current Output) .....	3-5
3.3	Wiring to the Connector .....	3-6
3.3.1	Suitable Parts and Tools .....	3-6
3.3.2	Wire Connection Method .....	3-6

## 3.1 Connecting Analog Input

### 3.1 Connecting Analog Input

#### 3.1.1 Precautions When Connecting Analog Signal



- Use double-core twisted-pair shielded wires for connecting analog signals.
- Connect the shield of the shielded cable to the ground on the load device side.  
However, depending on the conditions of the external noise, it may be better to ground externally or not to ground the shield.
- Do not have the analog input wiring close to AC wires, power wires, or load line from a device other than the Motion Controller. Also, do not bundle it with them.
- The NC terminals on the terminal block are unused. Do not use these terminals to relay wires because the terminals include those connected internally.

#### 3.1.2 Terminal Layout Diagram of the GM1 Analog Input Unit

The terminal used by the analog voltage input is common to that used by the analog current input.

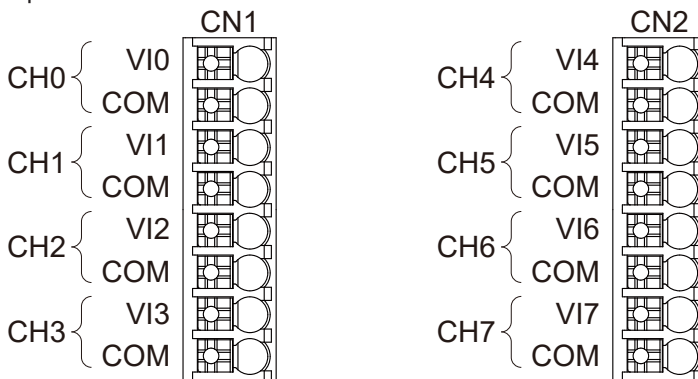

#### 3.1.3 Analog Input Circuit and Wiring

This section describes the input circuit and wiring of the analog input unit. The circuit for the voltage input is the same as that for the current input.

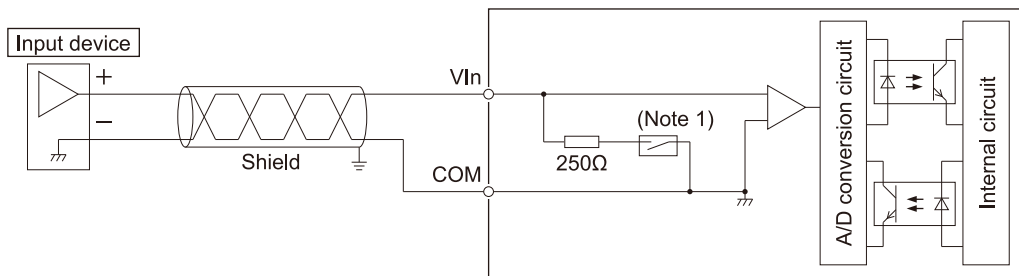

## 3.1 Connecting Analog Input

---

(Note 1) The circuit connection varies depending on parameter settings.

(Note 2) "n" indicates the channel number. (0 to 7)

## 3.2 Analog Output Connections

### 3.2 Analog Output Connections

#### 3.2.1 Precautions When Connecting Analog Signal



- Use double-core twisted-pair shielded wires for connecting analog signals.
- Connect the shield of the shielded cable to the ground on the load device side.  
However, depending on the conditions of the external noise, it may be better to ground externally or not to ground the shield.
- Do not have the analog input wiring close to AC wires, power wires, or load line from a device other than the Motion Controller. Also, do not bundle it with them.
- The NC terminals on the terminal block are unused. Do not use these terminals to relay wires because the terminals include those connected internally.

#### 3.2.2 Terminal Layout Diagram of the GM1 Analog Output Unit

The terminals used when the output range is set to the voltage output are different from those used for the current output.

- For the voltage output: Vn
  - For the current output: In
- "n" indicates the channel number. (0 to 3)

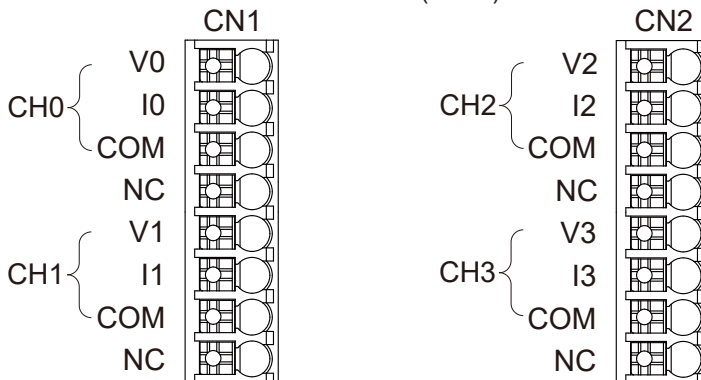

#### 3.2.3 Analog Output Circuit and Wiring (For the Voltage Output)

This section describes the output circuit and wiring of the analog output unit when the output range is set to the voltage output (-10 to +10 V, 0 to +10 V, -5 to +5 V, 0 to +5 V, +1 to +5 V).

### Internal circuit diagram and connection diagram

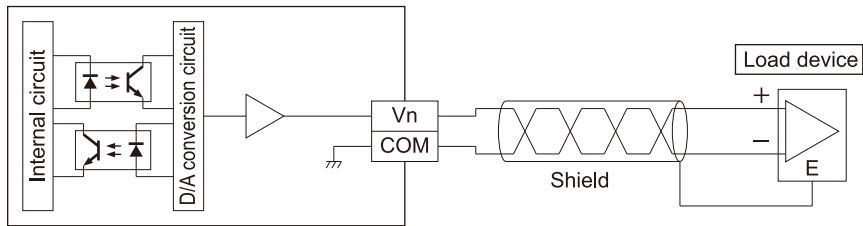

(Note 1) "n" indicates the channel number. (0 to 3)

### 3.2.4 Analog Output Circuit and Wiring (For the Current Output)

This section describes the output circuit and wiring of the analog output unit when the output range is set to the current output (0 to +20 mA, +4 to +20 mA).

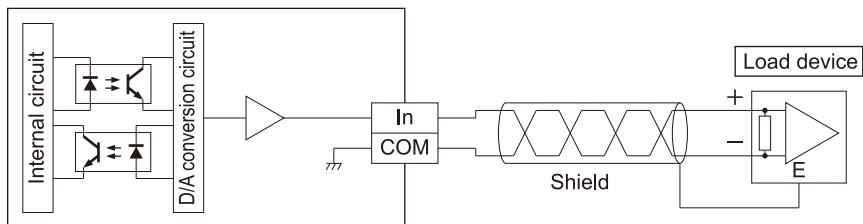

(Note 1) "n" indicates the channel number. (0 to 3)

### 3.3 Wiring to the Connector

#### 3.3 Wiring to the Connector

##### 3.3.1 Suitable Parts and Tools

A spring connection type is used for the terminal block of the analog I/O section. Perform wire connection properly by referring to the compatible products listed in the following tables.

##### Compatible wires (stranded wire)

Size	Nominal cross-sectional area
AWG#24 to 16	0.2 mm <sup>2</sup> to 1.5 mm <sup>2</sup>

##### Rod terminals with compatible insulation sleeve

Manufacturer	Cross-sectional area	Size	Model number
Phoenix Contact Co., Ltd.	0.25 mm <sup>2</sup>	AWG#24	AI 0.25-8 YE
	0.50 mm <sup>2</sup>	AWG#20	AI 0.5-8 WH AI 0.5-10 WH
	0.75 mm <sup>2</sup>	AWG#18	AI 0.75-8 GY AI 0.75-10 GY

##### Crimping tool dedicated to rod terminals

Manufacturer	Model number	Product No.
Phoenix Contact Co., Ltd.	CRIMPFOX 6	1212034

##### 3.3.2 Wire Connection Method

Perform wire connection of the terminal block according to the following procedure.

#### 1<sub>2</sub> Procedure

1. Strip the sheath from the electric wire.

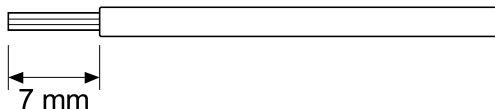

2. While pressing the tab on the terminal block using a flat-blade screwdriver, insert the wire all the way until it stops. Confirm that the electric wire is fixed in place when the screwdriver is released.



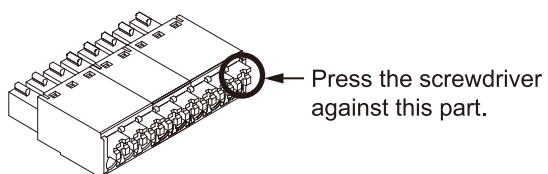

(Note 1) The above illustration shows an eight-pin type when it is removed from the unit.

(Note 2) Use a screwdriver listed in the following table as a dedicated tool or equivalent (blade width: 0.4 x 2.5).

Manufacturer	Model number	Production number
Phoenix Contact Co., Ltd	SZS 0, 4x2, 5	1205037



- The following precautions should be observed to avoid broken or disconnected wires.
  - When removing the wire's sheath, be careful not to scratch the core wire.
  - Do not twist the wires to connect them.
  - Do not solder the wires to connect them. The solder may break due to vibration.
  - After wiring, make sure stress is not applied to the wire.

(MEMO)

# 4 Project Creation

---

4.1 Adding Expansion Units.....	4-2
4.2 Setting Parameters and Performing I/O Mapping.....	4-5
4.3 Setting the Analog Input Unit.....	4-7
4.3.1 List of Analog_8IN Parameters.....	4-7
4.3.2 List of Analog_8IN I/O Mapping.....	4-8
4.4 Setting the Analog Output Unit.....	4-10
4.4.1 List of Analog_4OUT Parameters.....	4-10
4.4.2 List of Analog_4OUT I/O Mapping.....	4-11

## 4.1 Adding Expansion Units

### 4.1 Adding Expansion Units

This section explains how to add device objects for expansion units to a project. After the addition, the parameters and I/O mapping can be checked or changed.

The following explanation is provided for a case where a digital input unit (product number: AGM1X64D2) is added to Empty1.

The procedure is as follows:

#### 1 2 Procedure

1. Right-click the [Empty1] object in the navigation pane and then select "Unit Management" from the context-sensitive menu that is displayed.

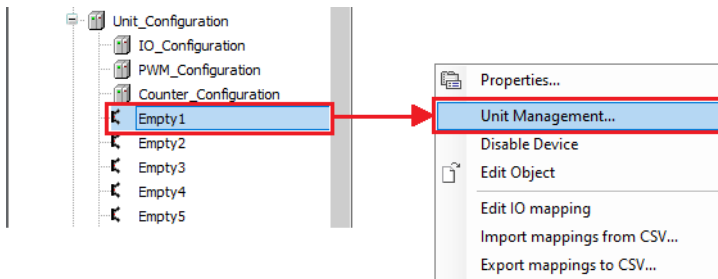

The "Unit Management" dialog box will be displayed.

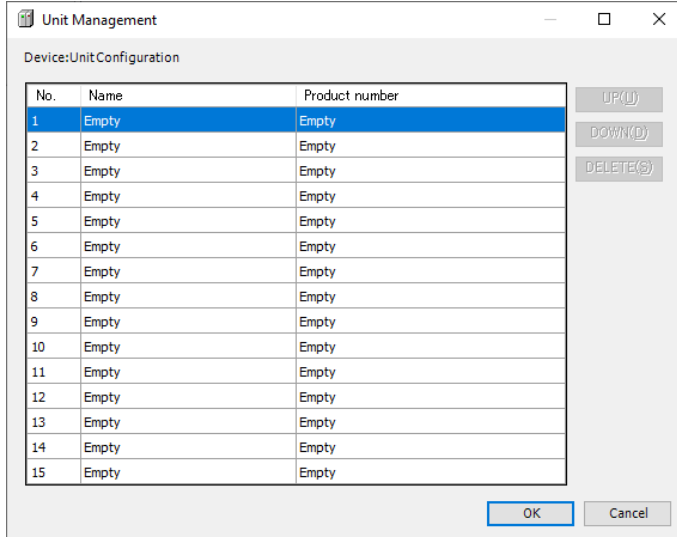

2. Double-click the first row in the "Device: Unit\_Configuration" table. The "Select Device" dialog box will be displayed.

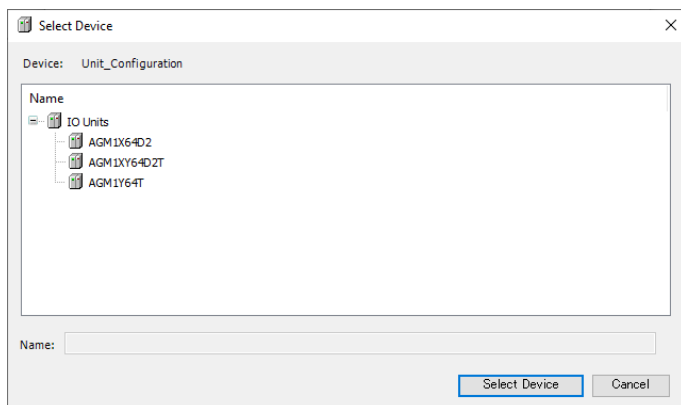

3. Select a device object for the expansion unit to be added.

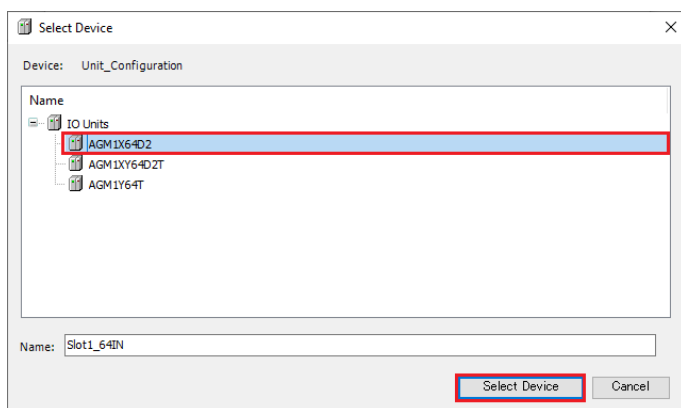

4. Click the [Select Device] button.  
The selected device object of the expansion unit will be added.

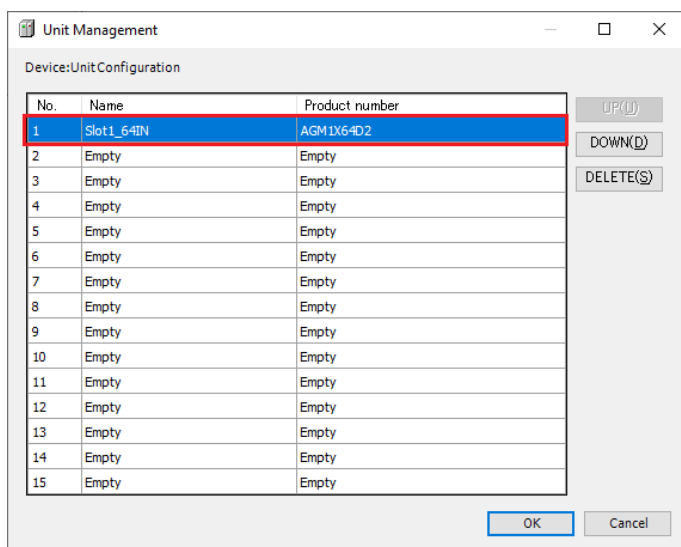

5. Click the [OK] button.

## 4.1 Adding Expansion Units

---

The selected device object of the expansion unit will be added to the navigation pane.

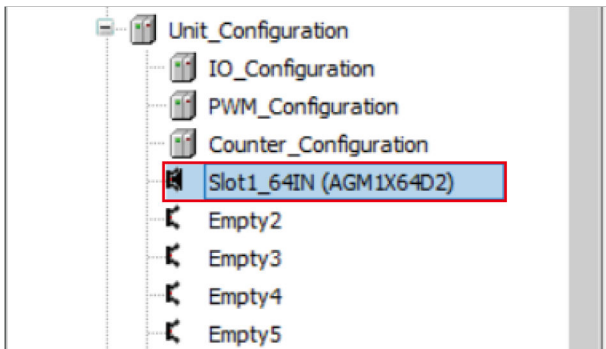

6. Double-click the added object.

The setting pane will be displayed in the main pane. Specify settings related to the expansion unit.

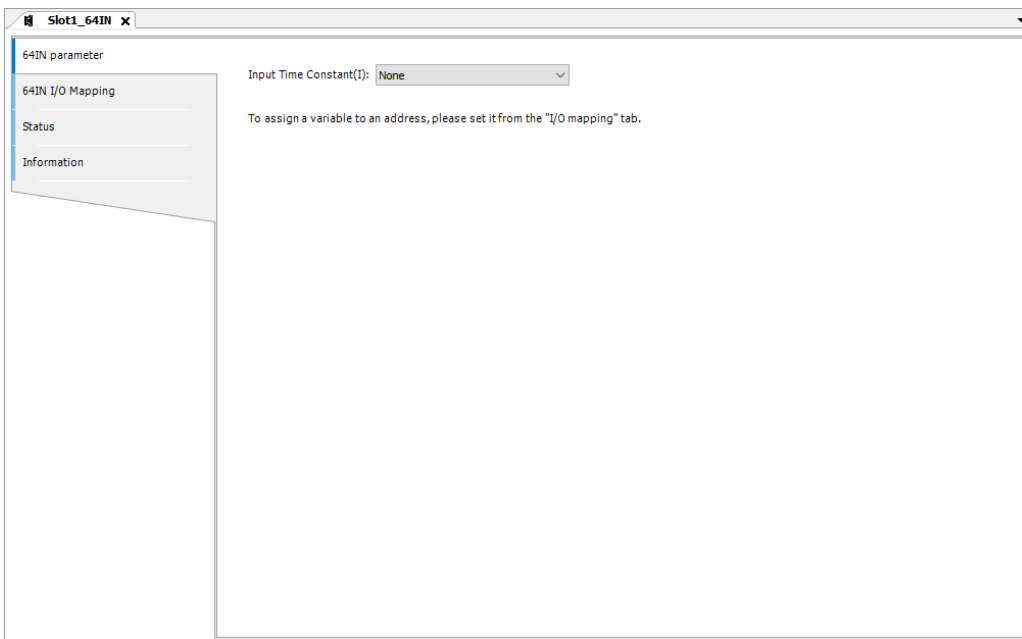

### **i** Info.

- To remove the device object of an expansion unit that has been added, select the expansion unit to be removed in the "Unit Management" dialog box and press the "Delete" key or click the [Delete] button.

## 4.2 Setting Parameters and Performing I/O Mapping

- Specify operations of analog input units and analog output units by setting parameters.
- Perform the following using I/O mapping.
  - You can create variables for each channel and use them in the control program.
  - Map them to existing variables so that variables correspond to channels.

### ■ Overview

- After adding analog I/O units to the project, select them from the device pane to change its parameters and to perform I/O.
- The analog I/O units are displayed as follows in the device pane.
  - The segments indicated by \* differ according to the expansion location.

Analog input unit	Slot*_Analog_8IN (AGM1AD8)
Analog output unit	Slot*_Analog_4OUT (AGM1DA4)

## 1 2 Procedure

Setting parameters of the analog input unit connected to the 1st unit

1. Double-click "Slot1\_Analog\_8IN(AGM1AD8)" in the device pane.

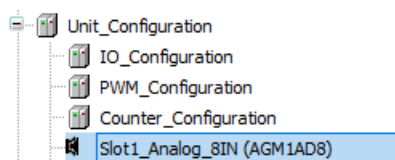

2. Click the "Analog\_8IN Parameters" tab.
3. Set parameters for each channel.

### Parameter setting example

Category Selection(T)

- [-] Unit specific configuration settings
  - Ch0\_Unit specific configuration settings
  - Ch1\_Unit specific configuration settings
  - Ch2\_Unit specific configuration settings
  - Ch3\_Unit specific configuration settings
  - Ch4\_Unit specific configuration settings
  - Ch5\_Unit specific configuration settings
  - Ch6\_Unit specific configuration settings
  - Ch7\_Unit specific configuration settings

Parameter Setting (R)

Parameter	Value
ConversionProcess	Execute
RangeSetting	0 ~ 20mA ▾
AveragingProcess	Time-based average
AverageConstant	200
OffsetGainProcess	Not Execute
OffsetValue	0
GainValue	1000

(Note 1) In this example, the analog input range for channel 3 is set to "0 to 20 mA".

4. Click the "Analog\_8IN I/O Mapping" tab.
5. Individually map variables that can be used for the program to the channel to be used.







## 4.2 Setting Parameters and Performing I/O Mapping

---

- By directly inputting a variable name, you can create a new variable in the "I/O Mapping" window.
- Click  to map to an existing variable.

### I/O mapping input example

 Application.PRG_Sample.iCh0_ConversionValue	 Ch0_ConversionValue
 iCh0_MaxHoldingValue	 Ch0_MaxHoldingValue

(Note 1) In this example, variables are registered as shown in the following table.

Channel	Variables
Ch0_ConversionValue	Map to the variable "iCh0_MaxHoldingValue" created in the program "PRG_Sample".
Ch0_MaxHoldingValue	Create a new variable "iCh0_MaxHoldingValue".

### Note

- For the description of parameters to be set and channels, see the next page.



## 4.3 Setting the Analog Input Unit

### 4.3.1 List of Analog\_8IN Parameters

The following table shows a list of changeable parameters for the GM1 Analog Input Unit. Set parameter for each channel.

Setting item	Default	Description
ConversionProcess	Execute	Select "Execute / Not Execute" of the analog input.
RangeSetting	-10 to +10 V	Select the input range. -10 to +10 V 0 to +10 V -5 to +5 V 0 to +5 V +1 to +5 V 0 to +20 mA +4 to +20 mA
AveragingProcess	Not execute	Select the operation for input average processing. No averaging / Count-based average / Time-based average / Moving average
AverageConstant	200	Specify the constant for input average processing <b>Count-based average</b> Average count: 2 to 60,000 [times] <b>Time-based average</b> Average time: 1 to 1,500 [ms] <b>Moving average</b> Average count: 2 to 2,000 [times]
OffsetGainProcess	Not Execute	Select "Execute / Not Execute" for the Offset / Gain processing.
OffsetValue	0	Specify the offset value for when the Offset / Gain processing is executed. -3000 to +3000
Gain value	10000 (multiplied by 1.0)	Specify the gain value for when the Offset / Gain processing is executed. +9000 to +11000 (multiplied by 0.9 to 1.1)
ScaleConversion	Not execute	Select "Execute / Not execute" for the scale conversion.
ScaleConversionMaxValue	10000	Specify the maximum value after scale conversion is executed. -32768 to +32767
ScaleConversionMinValue	0	Specify the minimum value after scale conversion is executed. -32768 to +32767
UpperAndLowerLimitComparison	Not Execute	Select "Execute / Not Execute" for the upper limit / lower limit comparison.

## 4.3 Setting the Analog Input Unit

Setting item	Default	Description
UpperLimitComparisonONLevel	1000	Specify the upper limit comparison ON level. -32768 to +32767
UpperLimitComparisonOFFLevel	1000	Specify the upper limit comparison OFF level. -32768 to +32767
LowerLimitComparisonONLevel	0	Specify the lower limit comparison ON level. -32768 to +32767
LowerLimitComparisonOFFLevel	0	Specify the lower limit comparison OFF level. -32768 to +32767
MaxMinValueRetention	Not execute	Select "Not execute / Execute" for the Max. / Min. hold.
DisconnectionDetection	Not execute	Select "Not execute / Execute" for the disconnection detection.
DisconnectionDetectionReset	Automatic reset	Select reset operation when disconnection detection is executed. Automatic reset / Manual reset

### 4.3.2 List of Analog\_8IN I/O Mapping

This section explains operations of channels used by the GM1 Analog Input Unit.

#### ■ InputArea (input area)

- The asterisk "\*" represents the channel number. (0 to 7)

Channel	Type	Description	Operation
Ch*_InputValue	INT	Ch*_Analog Input Value	Stores a digital value equivalent to the analog input signal. Stores a value before "Offset / Gain processing" and "scale conversion" are executed.
Ch*_ConversionValue	INT	Ch*_Analog Conversion Value	Stores a digital conversion value equivalent to the analog input signal. Stores a value after "Offset / Gain processing" and "scale conversion" are executed.
Ch*_MaxHoldingValue	INT	Ch*_Max Holding Value	Holds the maximum value of the digital conversion value while the Max. / Min. hold is executed.
Ch*_MinHoldingValue	INT	Ch*_Min Holding Value	Holds the minimum value of the digital conversion value while the Max. / Min. hold is executed.
Ch*_StatusRegister	WORD	Ch*_Status Register	Sets the following statuses in bulk in units of WORD.
Ch*_DisconnectionDetection Status	BOOL	Ch*_Disconnection Detection Status	When disconnection is detected: ON, when disconnection is restored: OFF Enabled only when 1-5 V, 4-20 mA range is selected.

Channel	Type	Description	Operation
Ch*_UpperLimitComparisonStatus	BOOL	Ch*_Upper Limit Comparison Status	Turns ON when the comparison value exceeds the preset upper limit while the upper limit / lower limit comparison function is executed.
Ch*_LowerLimitComparisonStatus	BOOL	Ch*_Lower Limit Comparison Status	Turns ON when the comparison value falls below the preset lower limit while the upper limit / lower limit comparison function is executed.
Ch*_UpperLowerLimitComparisonStatus	BOOL	Ch*_Upper /Lower Limit Value Comparison Status	While the upper limit / lower limit comparison function is executed: ON
Ch*_MaxMinHoldingStatus	BOOL	Ch*_Max/Min. Holding Value Status	While the Max. / Min. hold is executed: ON While the Max. / Min. hold is stopped: OFF
Ch*_SettingErrorStatus	BOOL	Ch*_Error Status	Turns ON when an error occurs.

### ■ OutputArea (output area)

- The asterisk "\*" represents the channel number. (0 to 7)

Channel	Type	Description	Operation
Ch*_RequestRegister	WORD	Ch*_Request Register	Sets the following request in bulk in units of WORD.
Ch*_DisconnectionDetectionExecutionRequest	BOOL	Ch*_Disconnection Detection Request	ON: Disconnection detection is executed. OFF: Disconnection detection is stopped. Validity condition: Level
Ch*_UpperLowerLimitComparisonRequest	BOOL	Ch*_Upper /Lower Limit Value Comparison Request	ON: Upper limit / lower limit comparison is executed. OFF: Upper limit / lower limit comparison is stopped. Validity condition: Level
Ch*_MaxMinHoldingRequest	BOOL	Ch*_Max/Min Holding Value Request	ON: Max. / Min. hold is executed. OFF: Max. / Min. hold is stopped. Validity condition: Level

## 4.4 Setting the Analog Output Unit

### 4.4 Setting the Analog Output Unit

#### 4.4.1 List of Analog\_4OUT Parameters

The following table shows a list of changeable parameters for the GM1 Analog Output Unit. Set parameter for each channel.

Parameter	Default	Settings
OutputProcess	Output	Select "Output / No output" of the analog output.
RangeSetting	-10 V to +10 V	Select the output range. -10 to +10 V 0 to +10 V -5 to +5 V 0 to +5 V +1 to +5 V 0 to +20 mA +4 to +20 mA
OutputValueSettingAtStop	Hold with user-specified value	Select the operation of the analog output hold function in the STOP mode. Hold with user-specified value / Hold at current value
OutputValueAtStop	0	Specify the output value when OutputValueAtStop is set to "Desired output value". <b>-32640 to +32640</b> (For -10 to +10 V, -5 to +5 V range) <b>0 to +32640</b> (For 0 to +10 V, 0 to +5 V, 0 to +20 mA) <b>0 to +25600</b> (For +1 to +5 V, +4 to +20 mA)
OffsetGainProcess	No output	Select "Output / No output" for the Offset / Gain processing.
OffsetValue	0	Specify the offset value for when the Offset / Gain processing is executed. -3000 to +3000
GainValue	10000 (multiplied by 1.0)	Specify the gain value for when the Offset / Gain processing is executed. +9000 to +11000 (multiplied by 0.9 to 1.1)
ScaleConversion	No output	Select "Output / No output" of the scale conversion.
ScaleConversionMaxValue	10000	Specify the maximum value after scale conversion is executed. -32768 to +32767
ScaleConversionMinValue	0	Specify the minimum value after scale conversion is executed. -32768 to +32767
UpperAndLowerOutputClipping	No output	Select "Output / No output" of the clipping function.

Parameter	Default	Settings
UpperAndLowerOutputClippingUpperLimit	0	Specify the upper limit of the clipping function. -32640 to +32640
UpperAndLowerOutputClippingLowerLimit	0	Specify the lower limit of the clipping function. -32640 to +32640

### 4.4.2 List of Analog\_4OUT I/O Mapping

The analog output unit is controlled by reading from and writing to the applicable channel using the user program.

#### ■ InputArea (input area)

- The asterisk "\*" represents the channel number. (0 to 3)

Channel type	Type	Description	Remarks
Ch*_StatusRegister	WORD	Ch*_Status Register	Sets the following statuses in bulk in units of WORD.
Ch*_SettingErrorStatus	BOOL	Ch*_Setting Error Status	Turns ON when an error occurs.
Ch*_ClippingUpperLimitStatus	BOOL	Ch*_Clipping Upper Limit Status	Turns ON when the value exceeds the output clipping upper limit while the clipping function is executed.
Ch*_ClippingLowerLimitStatus	BOOL	Ch*_Upper and lower output clipping Lower limit	Turns ON when the value falls below the output clipping lower limit while the clipping function is executed.

#### ■ OutputArea (output area)

- The asterisk "\*" represents the channel number. (0 to 3)

Channel	Type	Description	Remarks
Ch*_OutputValue	INT	Ch*_Analog Output Value	Stores the digital value for the analog output. The range of the stored value varies depending on the setting range and scale.
Ch*_RequestRegister	WORD	Ch*_Request Register	Sets the following request in bulk in units of WORD.
Ch*_ClippingFunctionExecutionRequest	BOOL	Ch*_Upper and lower output clipping Function execution relay	ON: The clipping function is executed. OFF: "Ch*_ClippingUpperLimit" and "Ch*_ClippingLowerLimit" are turned OFF. Validity condition: Level

(MEMO)

# 5 Functions of the Analog Input Unit

---

5.1 Basic Operation .....	5-2
5.1.1 Reading Analog Input Data .....	5-2
5.1.2 Input Setting and Conversion Processing Time .....	5-3
5.2 Average Processing Settings .....	5-5
5.2.1 Count-based Average .....	5-5
5.2.2 Time-based Average .....	5-6
5.2.3 Moving Average .....	5-6
5.3 Offset / Gain Processing Function .....	5-8
5.4 Scale Conversion Function .....	5-10
5.5 Upper Limit / Lower Limit Comparison Function .....	5-11
5.6 Max. / Min. Hold Function .....	5-14
5.7 Disconnection Detection Function .....	5-17

**5.1 Basic Operation**

**5.1.1 Reading Analog Input Data**

Analog input is processed as explained below.

■ **Operation of the analog input unit**

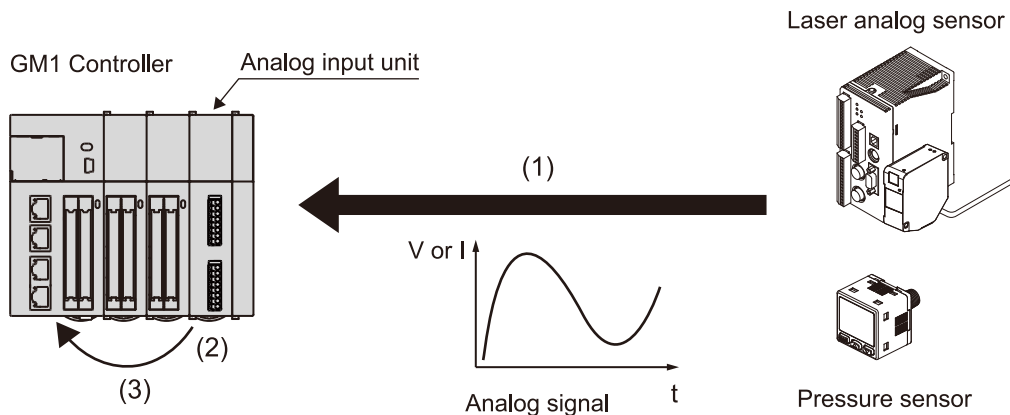

**(1) Receiving analog input**

The analog input unit receives analog input signal from analog devices, such as laser analog sensors and pressure sensors

**(2) Digital conversion processing**

Analog input signal received by the unit is converted into digital values in sequence automatically.

**(3) Storage of digital values**

The converted digital values are stored in the channel next to "Analog\_8IN I/O Mapping".

- The asterisk "\*" represents the channel number. (0 to 7)

Channel	Remarks
Ch*_InputValue	Stores a value before "Offset / Gain processing" and "scale conversion" are executed.
Ch*_ConversionValue	Stores a value after "Offset / Gain processing" and "scale conversion" are executed.

■ **Sample program**

The following program reads analog input data of ch0 into the variable "iLocal".

**Declaration section**

```
PROGRAM PRG_AIO1
VAR
    iCh0_ConversionValue: INT;
    iLocal: INT;
END_VAR
```



## Implementation section

```
iLocal := iCh0_ConversionValue; // Read Analog data
```

(Note 1) Separately link corresponding channels in "Analog\_8IN I/O Mapping".



## REFERENCE

### 4.2 Setting Parameters and Performing I/O Mapping

### 5.1.2 Input Setting and Conversion Processing Time

The conversion processing time varies with the "Input setting" of the Analog\_8IN parameter.

Select "Not execute / Execute" for the analog input conversion processing on a channel-by-channel basis.

This can save the conversion time for channels that do not execute conversion processing. The conversion time per channel is 50  $\mu$ s.

#### Example: Conversion time for converting one channel (when channels other than CH0 are set to "Disable")

Converts only ch0 repeatedly.

1 cycle = 50  $\mu$ s

#### Example: Conversion time for converting four channels (when CH4 to CH7 are set to "Disable")

Conversion is executed in the order of ch0→ch1→ch2→ch3→ch0→ch1→ch2→ch3→... And the conversion time for CH4 to CH7, which are set to non-execution, is saved.

1 cycle = 200  $\mu$ s

## Timing Chart of Input Processing

The conversion processing of the analog input unit is not synchronized with the I/O refresh of the GM1 Controller. Therefore, it is necessary to consider the I/O refresh of the GM1 Controller in addition to the conversion processing time.

### ■ Timing chart

- The data converted by the analog input unit is retrieved into the GM1 Controller at the I/O refresh timing.
- At the time when the GM1 Controller performs an I/O refresh, the latest data is retrieved into the "Ch0 input value" of the GM1 Controller.

# 5.1 Basic Operation

## For 1 channel (Conversion processing time: 50 us)

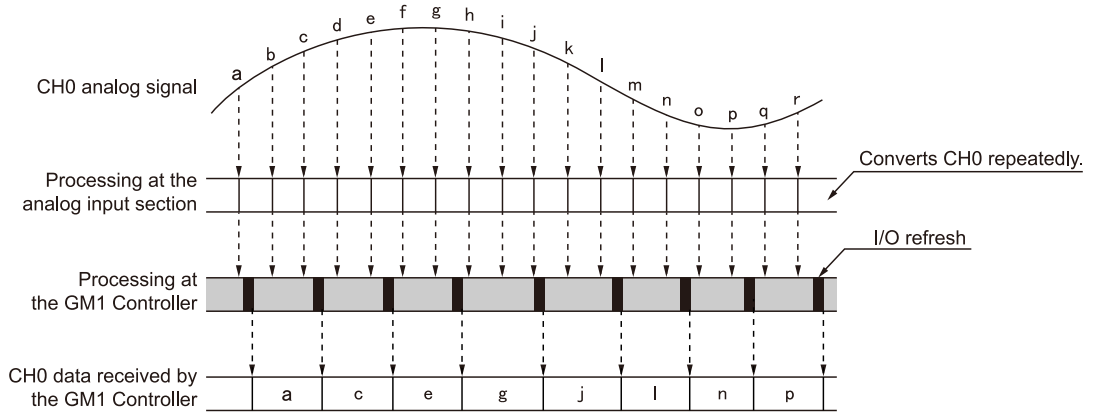

## For 4 channels (Conversion processing time: 200 us)

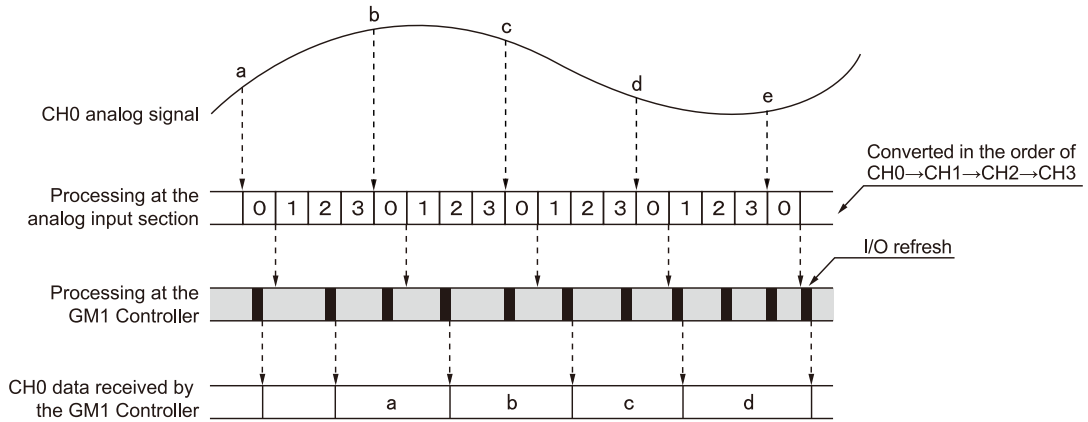

## 5.2 Average Processing Settings

Average processing is selected for the analog values taken in by sampling.

### 5.2.1 Count-based Average

#### ■ Overview of the function

- If the average processing is set to "Count-based average", analog input data acquired will be processed to find an average for the number of times and stored as digital values when the number of analog input data items reaches the number of averaging times.
- If the number of data items acquired is less than the number of averaging times, the data acquired for the first time will be stored in the I/O area.
- In processing the number of averaging times, obtain the number of averaging from the following input.

Input: The sum of analog input data for the number of averaging times set as averaging setting

Output: Number of averaging times value

#### ■ Processing during the count-based average

Average processing example: "Count-based average" is set to 5 for the number of sampling times.

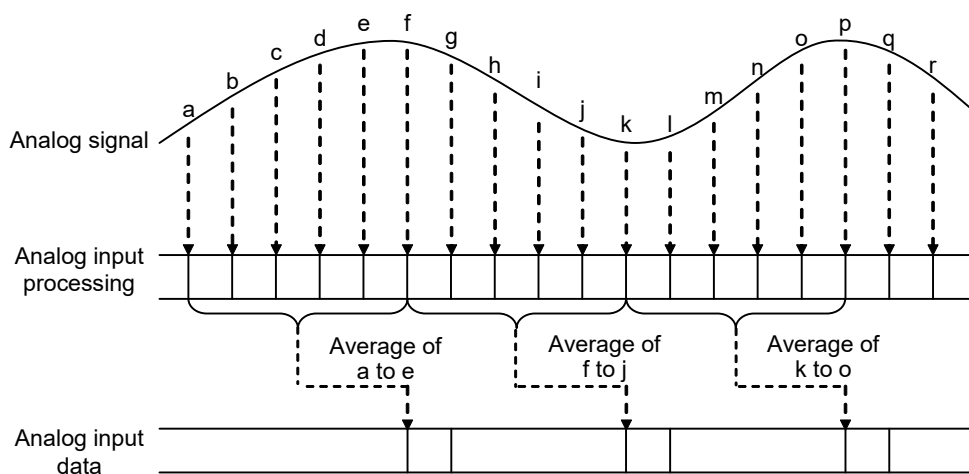

#### ■ Analog\_8IN parameters

Name	Default	Description
Averaging process	Not execute	Select "Count-based average".
Average constant	200	Specify the number of averaging times. Count: 2 to 60,000 [times]

## 5.2 Average Processing Settings

### 5.2.2 Time-based Average

#### ■ Overview of the function

- If the average processing is set to "Time-based average", analog input data acquired will be processed to find an average time and stored as digital values when the acquisition period of the analog input data items reaches the set averaging time
- In processing the time average, obtain the time average from the following input.  
Input: The sum of analog input data for the time set as averaging setting  
Output: Time average value

#### ■ Processing during time average

Average processing example: "Time-based average" is set to an averaging time of 5 ms

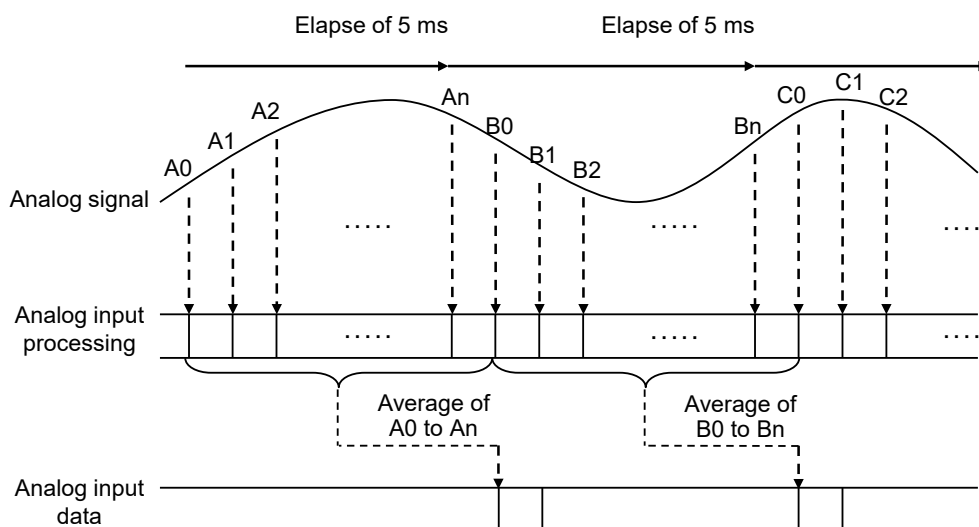

#### ■ Analog\_8IN parameters

Name	Default	Description
Averaging process	Not execute	Select "Time-based average".
Average constant	200	Specify the averaging time. Time: 1 to 1,500 [ms]

### 5.2.3 Moving Average

#### ■ Overview of the function

- If the average processing is set to "Moving average", analog input data acquired will be processed to a moving average and stored as digital values when the number of analog input data items reaches the number of averaging times.

- In the moving average, obtain output (moving average value) from the following input.  
 Input: The number of average times, analog input data for the number of average times, the latest analog input data, and old analog input data  
 Output: Moving average value

### ■ Processing during moving average

Average processing example: "Moving average" is set to 15 for the number of average times.

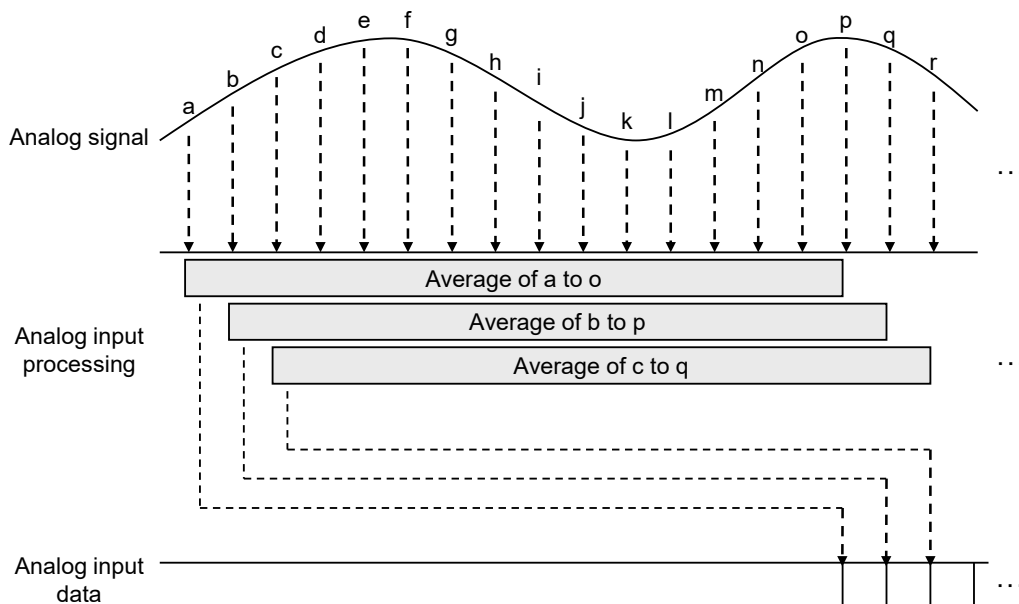

### ■ Analog\_8IN parameters

Name	Default	Description
Averaging process	Not execute	Select "Moving average".
Average constant	200	Specify the number of averaging times. Count: 2 to 2,000 [times]

## 5.3 Offset / Gain Processing Function

### 5.3 Offset / Gain Processing Function

#### ■ Overview of the function

- This function performs the correction of offset values (addition correction) or gain values (magnification correction).
- Stores the data after offset processing and gain processing in the I/O mapping.
- Offset / Gain processing is executed on a channel-by-channel basis.

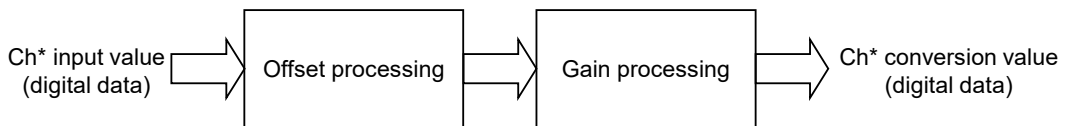

#### ■ Offset value setting

- Offset value settings are used as a function (zero-point adjustment) to make offset error adjustments between load devices.
- If the analog input value is "50" when the analog input signal is "0 V", the analog conversion data is corrected to "0" based on "-50" as an offset value.

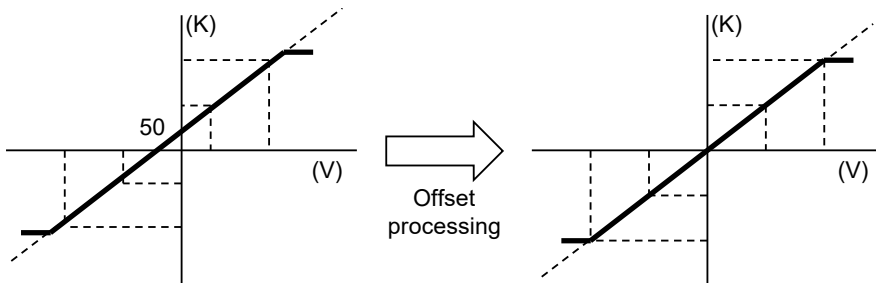

#### ■ Gain value setting

- Gain value settings are used as a function to adjust scale errors between load devices.
- The gain value slope can be changed in a range of x0.9 to x1.1.

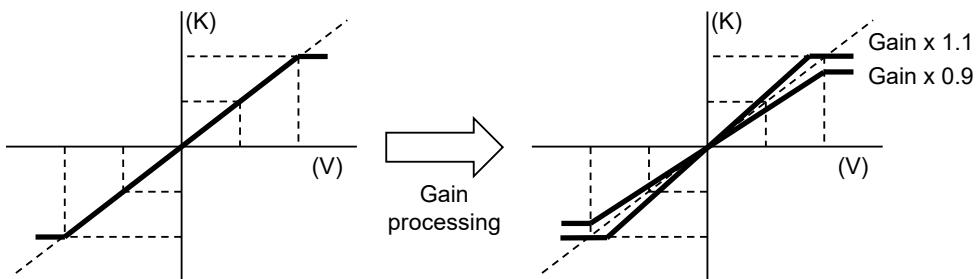

## ■ Analog\_8IN parameters

Name	Default	Description
Offset / Gain process	Not execute	Select "Execute".
Offset value	0	Set the offset value. Setting range: -3000 to +3000
Gain value	10000	Set the gain value. Setting range: +9000 to +11000 (multiplied by 0.9 to 1.1)

 Info.

- The offset value is corrected to a value corresponding to the resolution of the output range before scale conversion regardless of whether scale conversion is set or not.

## 5.4 Scale Conversion Function

### 5.4 Scale Conversion Function

#### ■ Overview of the function

- This function is to scale-convert analog input values to an easy-to-use data range.
- When the minimum value and the maximum value are set, analog input values are converted to digital values in the range between the minimum and maximum values as the full scale.
- The data after scale conversion is stored in the I/O mapping.
- The function can be used for unit conversion, etc.
- Scale conversion processing is executed on a channel-by-channel basis.

#### **i** Info.

- Conversion values read from the analog input unit are numbers including fractions. Therefore, convert the values to easy-to-handle figures if needed.

#### ■ Scale conversion processing

Voltage input range: Scale conversion when the input range of 1 to +5 V is converted to a scale between the minimum value of 0 and the maximum value of +10000

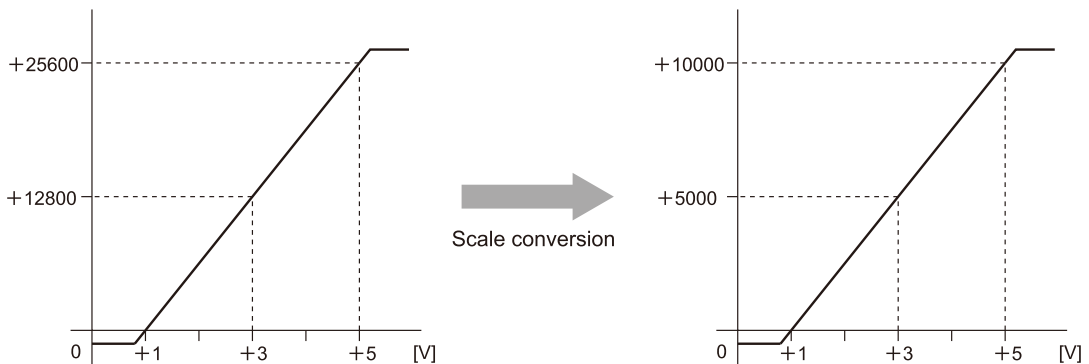

#### **i** Info.

- The input value ranges from the minimum scale value -2% to the maximum scale value +2%.
- If data outside this range is input, scale conversion will be disabled. The the minimum scale value -2% or the maximum scale value +2% will be stored as a converted value.

#### ■ Analog\_8IN parameters

Name	Default	Setting range and description
Scale conversion	Not execute	Select "Execute".
Scale conversion max value	+10000	Set the maximum value after scale conversion is executed. Setting range: -32768 to +32767
Scale conversion min value	0	Set the minimum value after scale conversion is executed. Setting range: -32768 to +32767



## 5.5 Upper Limit / Lower Limit Comparison Function

### ■ Overview of the function

- This function compares acquired analog input data with the preset upper limit and lower limit.

**When the acquired data exceeds the upper limit (digital conversion value is larger than the upper limit comparison ON level)**

Turns ON the "Ch\* upper limit comparison status".

**When the acquired data exceeds the lower limit (digital conversion value is smaller than the lower limit comparison ON level)**

Turns ON the "Ch\* lower limit comparison status".

- When **Analog\_8IN parameters>Upper and lower limit comparison** is set to "Execute", turn ON "Ch\* upper limit/lower limit comparison request" to execute the function.
- The upper limit / lower limit comparison processing is executed on a channel-by-channel basis.

### ■ Upper limit / lower limit comparison processing

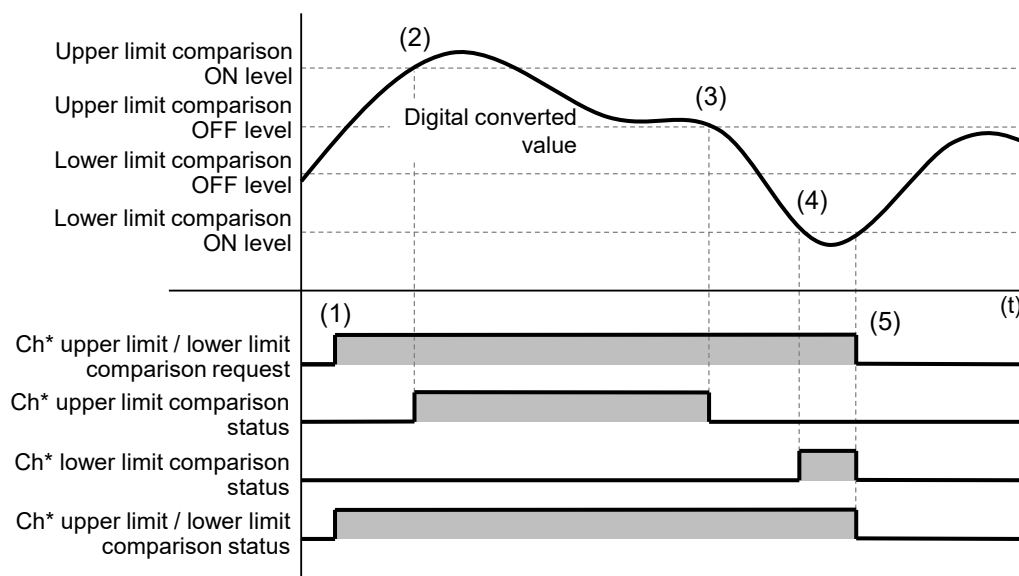

(1)	Turn ON "Ch* upper limit / lower limit comparison request" to execute the function.
(2)	When a value that is equal to or larger than the upper limit comparison ON level is detected, "Ch* upper limit comparison status" will turn ON.
(3)	When a value that is equal to or smaller than the upper limit comparison OFF level is detected, "Ch* upper limit comparison status" will turn OFF.
(4)	When a value that is equal to or smaller than the lower limit comparison ON level is detected, "Ch* lower limit comparison status" will turn ON.
(5)	The following I/O will be forcibly turned OFF if "Ch* upper limit / lower limit comparison request" is turned OFF. "Ch* upper limit comparison status" "Ch* lower limit comparison status"

## 5.5 Upper Limit / Lower Limit Comparison Function

	"Ch* upper limit / lower limit comparison status"
--	---

### ■ Analog\_8IN parameters

Setting item	Default	Description
Upper and lower limit comparison	Not execute	Select "Execute".
Upper limit comparison ON level	1000	Specify the upper limit comparison ON level. -32768 to +32767
Upper limit comparison OFF level	1000	Specify the upper limit comparison OFF level. -32768 to +32767
Lower limit comparison ON level	0	Specify the lower limit comparison ON level. -32768 to +32767
Lower limit comparison OFF level	0	Specify the lower limit comparison OFF level. -32768 to +32767

### ■ Analog\_8IN I/O Mapping

Channel	Description	Remarks
Ch*_UpperLowerLimitComparisonRequest	Ch* upper limit / lower limit comparison request	ON: Upper limit / lower limit comparison is executed. OFF: Upper limit / lower limit comparison is stopped. Validity condition: Level
Ch*_UpperLimitComparisonStatus	Ch* upper limit comparison status	Turns ON when the value exceeds the set upper limit.
Ch*_LowerLimitComparisonStatus	Ch* lower limit comparison status	Turns ON when the value exceeds the set lower limit.
Ch*_UpperLowerLimitComparisonStatus	Ch* upper limit / lower limit comparison status	Turns ON when the upper limit / lower limit comparison function is executed.

### ■ Sample program

The following program executes the upper limit / lower limit comparison function of the ch0. Specify a desired operation when the upper limit is detected or when the lower limit is detected.

#### Declaration section

```
PROGRAM PRG_AIO1
VAR
    bCh0_UpperLimitComparisonStatus: BOOL;
    bCh0_LowerLimitComparisonStatus: BOOL;
    bCh0_UpperLowerLimitComparisonRequest: BOOL;
    bCh0_UpperLowerLimitComparisonStatus: BOOL;
END_VAR
```

#### Implementation section

```
bCh0_UpperLowerLimitComparisonRequest := TRUE; // Start detection
IF bCh0_UpperLowerLimitComparisonStatus = TRUE THEN //Detection enabled
```

## 5.5 Upper Limit / Lower Limit Comparison Function

---

```
IF bCh0_UpperLimitComparisonStatus = TRUE THEN //Exceeded the upper limit
;
END_IF
IF bCh0_LowerLimitComparisonStatus = TRUE THEN //Below the lower limit
;
END_IF
END_IF
```

(Note 1) Separately link corresponding channels in "Analog\_8IN I/O Mapping".

 Application.PRG_AIO1.bCh0_UpperLimitComparisonStatus		Ch0_UpperLimitComparisonStatus
 Application.PRG_AIO1.bCh0_LowerLimitComparisonStatus		Ch0_LowerLimitComparisonStatus
 Application.PRG_AIO1.bCh0_UpperLowerLimitComparisonStatus		Ch0_UpperLowerLimitComparisonStatus
 Application.PRG_AIO1.bCh0_UpperLowerLimitComparisonRequest		Ch0_UpperLowerLimitComparisonRequest

---

### REFERENCE

#### 4.2 Setting Parameters and Performing I/O Mapping

---

## 5.6 Max. / Min. Hold Function

### ■ Overview of the function

- This function maintains the maximum and minimum values of acquired analog input data.
- When **Analog\_8IN parameters>Max. / Min. value retention** is set to "Execute", turn ON "Ch\* Max. / Min. hold request" to execute the function.
- The maximum value and the minimum value stored in the input area of the I/O mapping are held even in the following cases.
  - When "Ch\* Max. / Min. hold request" is turned OFF
  - When the GM1 Controller is set to the STOP mode
- The Max. / Min. hold is executed on a channel-by-channel basis.

### ■ Max. / Min. hold processing

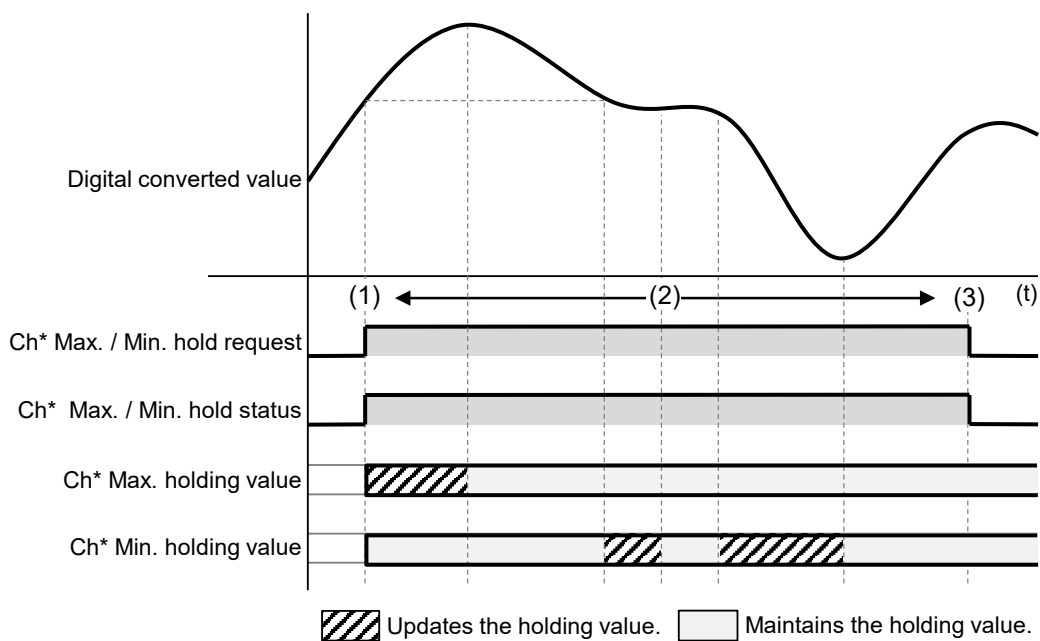

(1)	Turn ON "Ch* Max. / Min. hold request". The function is executed and "Ch* Max. / Min. hold status" is turned ON. The digital conversion values when the status is turned ON are preset into "Ch* Max. holding value" and "Ch* Min. holding value".
(2)	While "Ch* Max. / Min. hold status" is ON The maximum value and the minimum value of the digital conversion values are held and updated to "Ch* Max. holding value" and "Ch* Min. holding value".
(3)	Turn OFF "Ch* Max. / Min. hold request". "Ch* Max. / Min. hold status" is turned OFF. The maximum value and the minimum value stored in "Ch*Max. holding value" and "Ch* Min. holding value" are held.

### ■ Analog\_8IN parameters

Setting item	Default	Description
Max. / Min. value retention	Not execute	Select "Execute".

### ■ Analog\_8IN I/O Mapping

Channel	Description	Remarks
Ch*_MaxMinHoldingRequest	Ch* Max. / Min. hold request	ON: Max. / Min. hold is executed. OFF: Max. / Min. hold is stopped. Validity condition: Level
Ch*_MaxHoldingValue	Ch* Max. holding value	Holds the maximum value of the digital conversion value.
Ch*_MinHoldingValue	Ch* Min. holding value	Holds the minimum value of the digital conversion value.
Ch*_MaxMinHoldingStatus	Ch* Max. / Min. hold status	While the Max. / Min. hold is executed: ON While the Max. / Min. hold is stopped: OFF

### ■ Sample program

The following program executes the Max. / Min. hold function of the ch0 Specify a desired operation when "Ch0\_MaxHoldingValue" exceeds 10000 or when "Ch0\_MinHoldingValue" becomes less than 10000.









#### Declaration section

```
PROGRAM PRG_AIO1
VAR
  iCh0_MaxHoldingValue: INT;
  iCh0_MinHoldingValue: INT;
  bCh0_MaxMinHoldingRequest: BOOL;
  bCh0_MaxMinHoldingStatus: BOOL;
END_VAR
```

#### Implementation section

```
bCh0_MaxMinHoldingRequest := TRUE; // Start detection
IF bCh0_MaxMinHoldingStatus = TRUE THEN //Detection enabled
  IF iCh0_MaxHoldingValue > 10000 OR iCh0_MinHoldingValue < -10000 THEN //Check holding value
    ;
  END_IF
END_IF
```

(Note 1) Separately link corresponding channels in "Analog\_8IN I/O Mapping".

 Application.PRG_AIO1.iCh0_MaxHoldingValue		Ch0_MaxHoldingValue
 Application.PRG_AIO1.iCh0_MinHoldingValue		Ch0_MinHoldingValue
 Application.PRG_AIO1.bCh0_MaxMinHoldingStatus		Ch0_MaxMinHoldingStatus
 Application.PRG_AIO1.bCh0_MaxMinHoldingRequest		Ch0_MaxMinHoldingRequest

## 5.6 Max. / Min. Hold Function

---

---

### REFERENCE

---

4.2 Setting Parameters and Performing I/O Mapping

---

## 5.7 Disconnection Detection Function

### ■ Overview of the function

- This function turns ON the disconnection detection status when input is disconnected or unconnected, and warns of the error state.
- The disconnection detection function operates only in the following ranges.

Range	Detecting level
1 to 5 V	0.7 V or less
4 to 20 mA	2.8 mA or less

- When **Analog\_8IN parameters>Disconnection detection** is set to "Execute", turn ON "Ch\* disconnection detection request" to execute the function.

### ■ Operation when "Disconnection detection reset" is set to "Auto"

When the input value exceeds the detection level while "Ch\* disconnection detection request" is ON, "Ch\* disconnection detection status" automatically turns OFF.

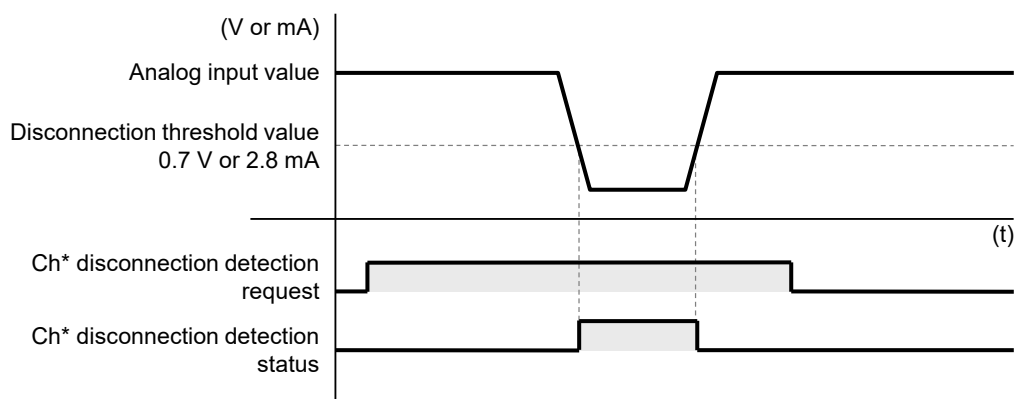

### ■ Operation when "Disconnection detection reset" is set to "Manual"

In the manual setting, turn OFF "Ch\* disconnection detection request" using the user program, and "Ch\* disconnection detection status" will be turned OFF.

## 5.7 Disconnection Detection Function

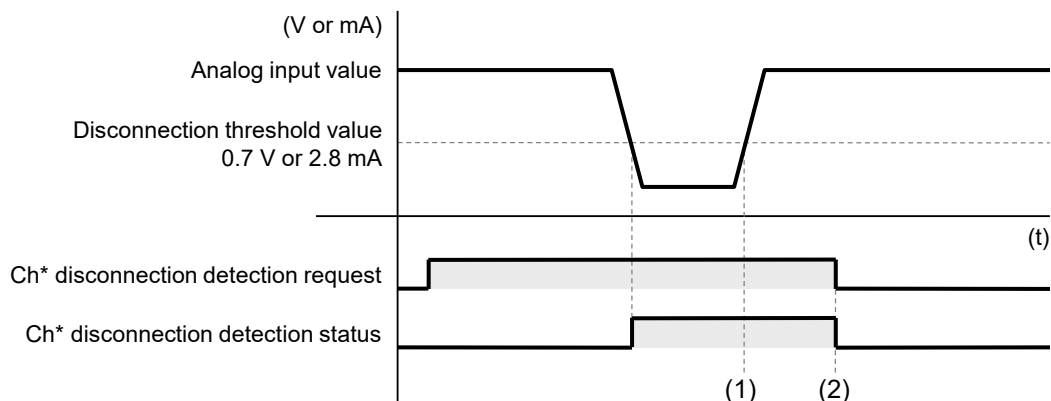

(1)	"Ch* disconnection detection status" does not turn OFF automatically even when the disconnection is restored.
(2)	When "Ch* disconnection detection request" is set to OFF, "Ch* disconnection detection status" turns OFF.

### ■ Analog\_8IN parameters

Setting item	Default	Description
Disconnection detection	Not execute	Select "Execute".
Disconnection detection reset	Auto reset	Select reset operation when disconnection detection is executed. Auto reset / manual reset

### ■ Analog\_8IN I/O Mapping

Channel	Description	Remarks
Ch*_DisconnectionDetectionExecutionRequest	Ch* disconnection detection request	ON: Disconnection detection is executed. OFF: Disconnection detection is stopped. Validity condition: Level
Ch*_DisconnectionDetectionStatus	Ch* disconnection detection status	When disconnection is detected: ON, when disconnection is restored: OFF Enabled only when the 1 to 5 V or 4 to 20 mA range is selected.

### ■ Sample program

The following program executes the disconnection detection function of the ch0. Specify a desired operation when a disconnection is detected.

#### Declaration section





```
PROGRAM PRG_AI01
VAR
    bCh0_DisconnectionDetectionExecutionRequest: BOOL;
    bCh0_DisconnectionDetectionStatus: BOOL;
END_VAR
```



### Implementation section

```
bCh0_DisconnectionDetectionExecutionRequest := TRUE; // Start detection
IF bCh0_DisconnectionDetectionStatus = TRUE THEN //Disconnection occurred
;
END_IF
```

(Note 1) Separately link corresponding channels in "Analog\_8IN I/O Mapping".

 Application.PRG_AIO1.bCh0_DisconnectionDetectionStatus		Ch0_DisconnectionDetectionStatus
 Application.PRG_AIO1.bCh0_DisconnectionDetectionExecutionRequest		Ch0_DisconnectionDetectionExecutionRequest

---

### REFERENCE

[4.2 Setting Parameters and Performing I/O Mapping](#)

---

(MEMO)

# 6 Functions of the Analog Output Unit

---

6.1 Basic Operation .....	6-2
6.1.1 Writing Analog Output Data .....	6-2
6.1.2 Timing Chart of Output Processing .....	6-3
6.2 Offset / Gain Processing Function .....	6-4
6.3 Scale Conversion Function .....	6-6
6.4 Clipping Function .....	6-7
6.5 Analog Output Hold Function in STOP Mode .....	6-9

**6.1 Basic Operation**

**6.1.1 Writing Analog Output Data**

■ **Basic operation of analog output**

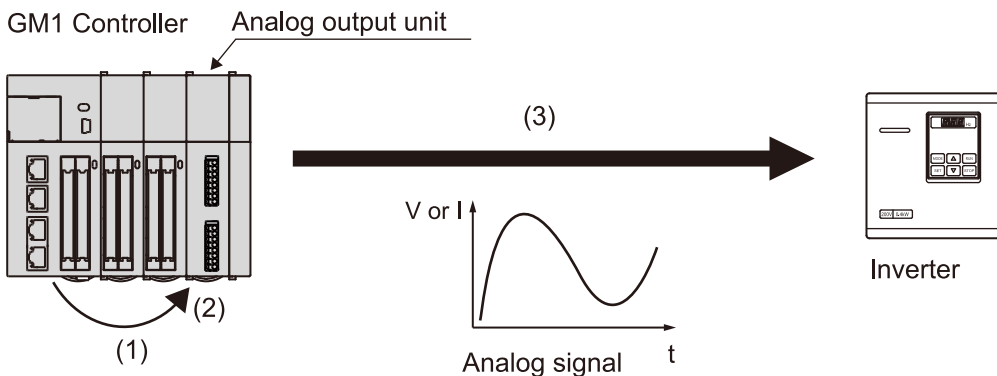

**(1) Writing digital data**

A user program is used to write digital data to the variable that corresponds to the analog output unit channel "Ch\*\_OutputValue".

The converted analog signal varies with the setting of the range.

**(2) Analog conversion processing**

Data written to the unit is converted to an analog signal in sequence automatically.

**(3) Output to analog-driven equipment**

Converted analog signal are output to inverters or other analog-driven equipment.

■ **Sample program**

In the following program, analog output data of ch0 "1000" of the analog output unit is written.

**Declaration section**

```
PROGRAM PRG_DAO1
VAR
    iCh0_OutputValue: INT;
END_VAR
```

**Implementation section**

```
iCh0_OutputValue := 10000;
```

(Note 1) Separately link corresponding channels in "Analog\_4OUT I/O Mapping".

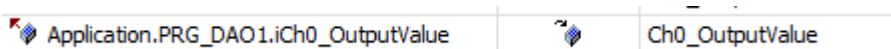

---

**REFERENCE**

---

## 4.2 Setting Parameters and Performing I/O Mapping

**6.1.2 Timing Chart of Output Processing**

The processing of the analog output unit is not synchronized with the processing of the GM1 Controller. Therefore, it is necessary to consider the I/O refresh of the GM1 Controller in addition to the conversion time of 50  $\mu$ s.

**■ Timing chart**

- The "Ch0 output value" written to the GM1 Controller is received by the analog output unit at the I/O refresh timing.
- The analog output unit converts the latest data received from the GM1 Controller into analog values and outputs the converted values.

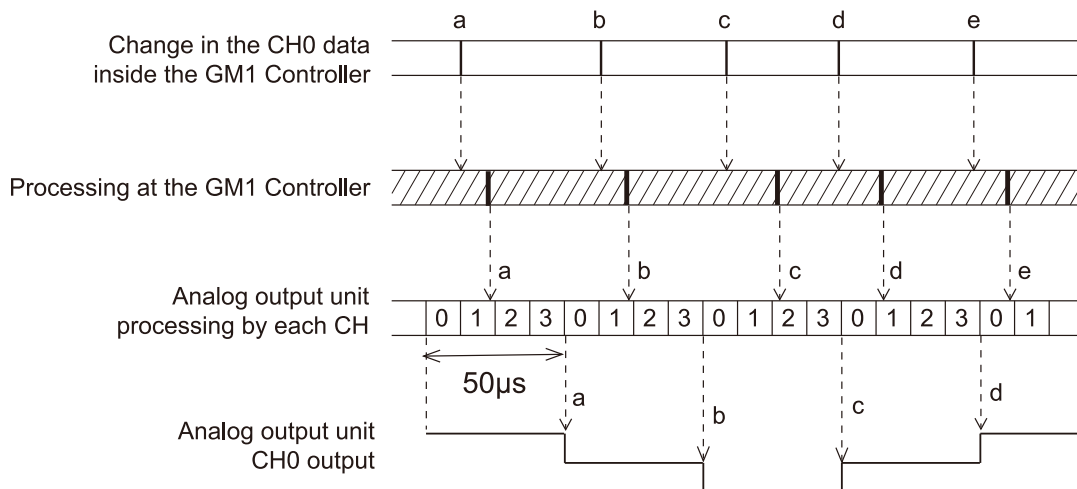

(Note 1) The processing time of the analog output unit is 50  $\mu$ s regardless of the number of channels.

(Note 2) The unit outputs converted values when all processing is completed for CH0 to CH3.

## 6.2 Offset / Gain Processing Function

### 6.2 Offset / Gain Processing Function

#### ■ Overview of the function

- This function performs the correction of offset values (addition correction) or gain values (magnification correction).
- Offset / Gain processing is executed on a channel-by-channel basis.

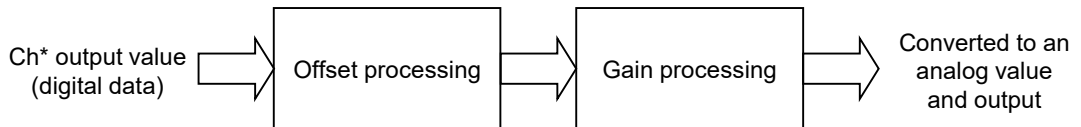

#### ■ Offset value setting

- Offset value settings are used as a function (zero-point adjustment) to make offset error adjustments between load devices.
- If the analog output signal is "0 V" when "-50" is stored as the analog output value:  
When the offset value is set to "50", the analog output signal is corrected to "0 V".

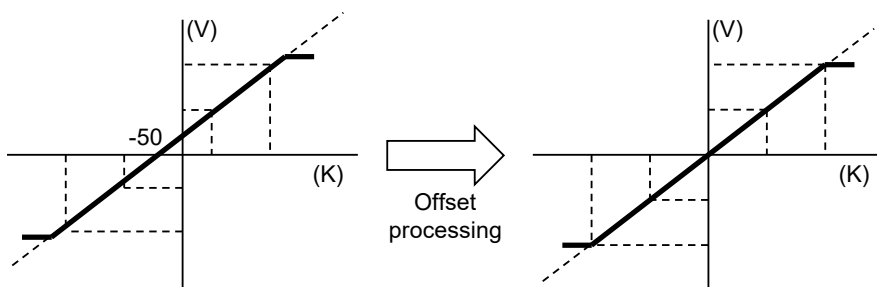

#### ■ Gain value setting

- Gain value settings are used as a function to adjust scale errors between load devices.
- The gain value slope can be changed in a range of x0.9 to x1.1.

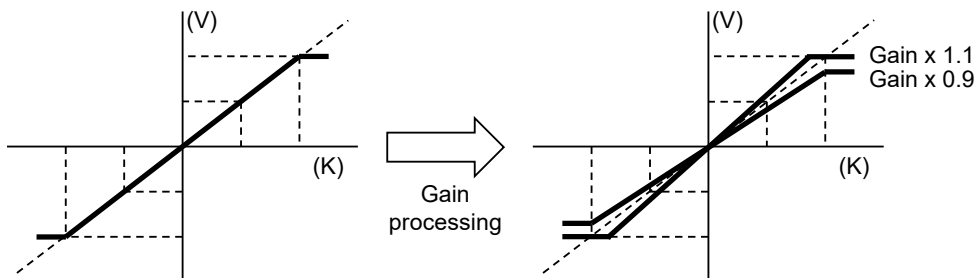

#### ■ Analog\_4OUT parameters

Name	Default	Description
Offset / Gain process	Disable	Select "Enable".
Offset value	0	Set the offset value.

Name	Default	Description
		Setting range: -3000 to +3000
Gain value	10000	Set the gain value. Setting range: +9000 to +11000 (multiplied by 0.9 to 1.1)

### **i** Info.

- The offset value is corrected to a value corresponding to the resolution of the output range before scale conversion regardless of whether scale conversion is set or not.

## 6.3 Scale Conversion Function

### 6.3 Scale Conversion Function

#### ■ Overview of the function

- This function is to scale-convert values to an easy-to-use analog output range.
- When the minimum value and the maximum value are set in advance, D/A conversion is made in the range between the minimum and maximum values as the full scale.
- Scale conversion processing is executed on a channel-by-channel basis.

#### ■ Scale conversion processing

Voltage output range: Scale conversion when the input range of 0 to +5 V is converted to a scale between the minimum value of 0 and the maximum value of +10,000

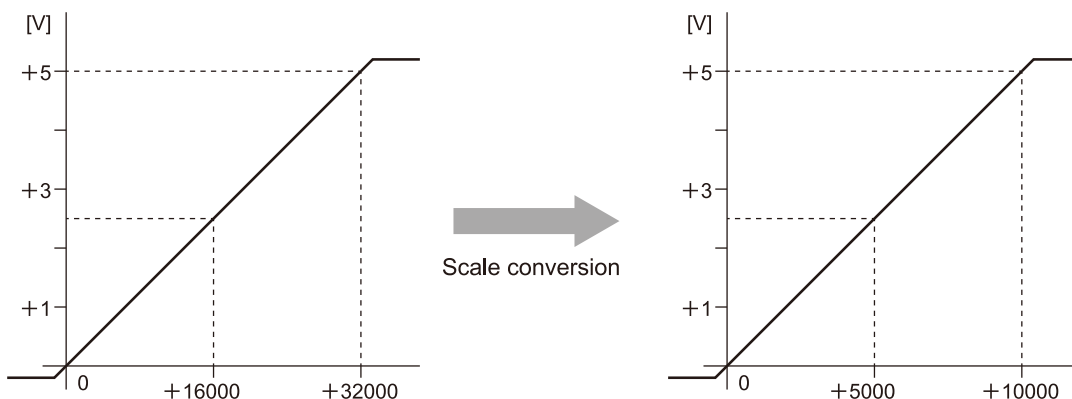

#### **i** Info.

- The output value ranges from the minimum scale value -2% to the maximum scale value +2%.
- If data is outside this range, scale conversion will be disabled. The value equivalent to the minimum scale value -2% or the value equivalent to the maximum scale value +2% will be converted and output as an analog value.

#### ■ Analog\_4OUT parameters

Name	Default	Setting range and description
Scale conversion	Disable	Select "Enable".
Scale conversion max value	10000	Set the maximum value after scale conversion is executed. -32768 to +32767
Scale conversion min value	0	Set the minimum value after scale conversion is executed. -32768 to +32767



## 6.4 Clipping Function

### ■ Overview of the function

- This function sets in advance the upper limit and lower limit for the analog output value.
- When a numerical value that exceeds the upper limit or lower limit is stored in the analog output value, the output is clipped by the preset values.
- This function makes it possible to prevent the wrong application of voltages or currents out of the specifications to equipment to be connected.
- When **Analog\_4OUT parameters>Upper and lower output clipping** is set to "Execute", turn ON "Ch\* clipping function execution request" to execute the function.
- The clipping function is set on a channel-by-channel basis.

### ■ Upper limit / lower limit clipping processing

#### For [Digital output value > Upper limit]

"Ch\* clipping upper limit status" turns ON.

#### For [Digital output value < Lower limit]

"Ch\* clipping lower limit status" turns ON.

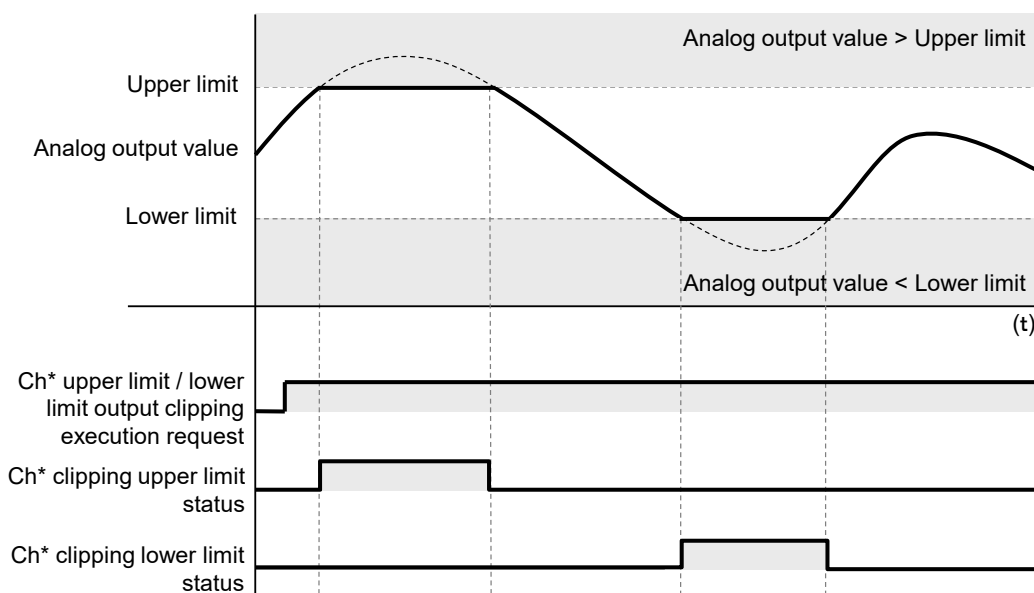

### ■ Analog\_4OUT parameters

Setting item	Default	Settings
Upper and lower output clipping	Not execute	Select "Execute".
Upper and lower output clipping upper limit	0	Specify the upper limit of the clipping function. -32640 to +32640
Upper and lower output clipping lower limit	0	Specify the lower limit of the clipping function. -32640 to +32640

## 6.4 Clipping Function

### ■ Analog\_4OUT I/O Mapping

Channel	Description	Remarks
Ch*_ClippingFunctionExecutionRequest	Ch* clipping function execution request	ON: The clipping function is executed. OFF: "Ch* clipping function upper limit" and "Ch* clipping function lower limit" are turned OFF. Validity condition: Level
Ch*_ClippingUpperLimitStatus	Ch* clipping function upper limit status	Turns ON when the value exceeds the output clipping upper limit while the clipping function is executed.
Ch*_ClippingLowerLimitStatus	Ch* clipping function lower limit status	Turns ON when the value falls below the output clipping lower limit while the clipping function is executed.

### Info.

- The upper limit and lower limit clip the output at the original output range resolution regardless of whether scale conversion is executed or not.

### ■ Sample program

The following program executes the clipping function of the ch0. Specify a desired operation when the upper limit is detected or when the lower limit is detected.







#### Declaration section

```
PROGRAM PRG_DAO1
VAR
    bCh0_ClipppingFunctionExecutionRequest: BOOL;
    bCh0_ClipppingUpperLimitStatus: BOOL;
    bCh0_ClipppingLowerLimitStatus: BOOL;
END_VAR
```

#### Implementation section

```
bCh0_ClipppingFunctionExecutionRequest := TRUE; // Start detection
IF bCh0_ClipppingUpperLimitStatus = TRUE THEN //Exceeded the upper limit
;
END_IF
IF bCh0_ClipppingLowerLimitStatus = TRUE THEN //Below the lower limit
;
END_IF
```

(Note 1) Separately link corresponding channels in "Analog\_4OUT I/O Mapping".

 Application.PRG_DAO1.bCh0_ClipppingUpperLimitStatus	 Ch0_ClipppingUpperLimitStatus
 Application.PRG_DAO1.bCh0_ClipppingLowerLimitStatus	 Ch0_ClipppingLowerLimitStatus
 Application.PRG_DAO1.bCh0_ClipppingFunctionExecutionRequest	 Ch0_ClipppingFunctionExecutionRequest

## REFERENCE

### 4.2 Setting Parameters and Performing I/O Mapping

## 6.5 Analog Output Hold Function in STOP Mode

### ■ Overview of the function

This function holds the analog output when the operation mode of the GM1 Controller changes from RUN to STOP.

- The analog output hold is set on a channel-by-channel basis.
- The analog output value can be set to "Desired output value" or "Current output value" for each channel.

### Info.

- The analog signal to be output varies with the setting of the range if "Desired output value" is selected.

### ■ Analog\_4OUT parameters

Name	Default	Setting range and description
Output value at STOP	Desired output value	Select the operation of the analog output hold function in the STOP mode. Desired output value / current output value
Output value at STOP <sup>(Note 1)</sup>	0	Specify the output value when the output setting in the STOP mode is set to "Desired output value". <b>-32640 to +32640</b> (For -10 to +10 V, -5 to +5 V range) <b>0 to +32640</b> (For 0 to +10 V, 0 to +5 V, 0 to +20 mA) <b>0 to +25600</b> (For +1 to +5 V, +4 to +20 mA)

(Note 1) This is enabled when the output setting in the STOP mode is set to "Desired output value".

### Info.

- The output will be turned OFF (0 V or 0 mA) if an error occurs.

(MEMO)

# 7 Conversion Characteristics of Analog Input Unit

---

7.1 Voltage Range .....	7-2
7.1.1 Voltage Input Range: -10 to +10 V (Resolution: 1/64,000) .....	7-2
7.1.2 Voltage Input Range: 0 to +10 V (Resolution: 1/32,000).....	7-3
7.1.3 Voltage Input Range: -5 to +5 V (Resolution: 1/64,000) .....	7-3
7.1.4 Voltage Input Range: 0 to +5 V (Resolution: 1/32,000).....	7-4
7.1.5 Voltage Input Range: +1 to +5 V (Resolution: 1/25,600) .....	7-5
7.2 Current Range .....	7-6
7.2.1 Current Input Range: 0 to +20 mA (Resolution: 1/32,000).....	7-6
7.2.2 Current Input Range: +4 to +20 mA (Resolution: 1/25,600) .....	7-6

## 7.1 Voltage Range

### 7.1 Voltage Range

#### 7.1.1 Voltage Input Range: -10 to +10 V (Resolution: 1/64,000)

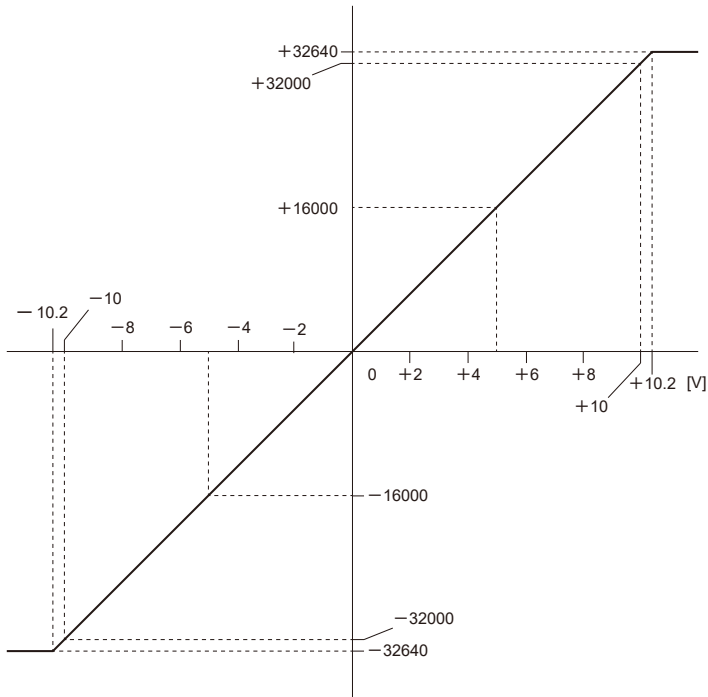

#### Input range: -10 to +10 V

Analog input value (V)	Digital converted value
+10	+32000
+8	+25600
+6	+19200
+4	+12800
+2	+6400
0	0
-2	-6400
-4	-12800
-6	-19200
-8	-25600
-10	-32000

#### When exceeding the rated range

Analog input value	Converted value
+10.2 V or more	+32640
-10.2 V or less	-32640

**7.1.2 Voltage Input Range: 0 to +10 V (Resolution: 1/32,000)**

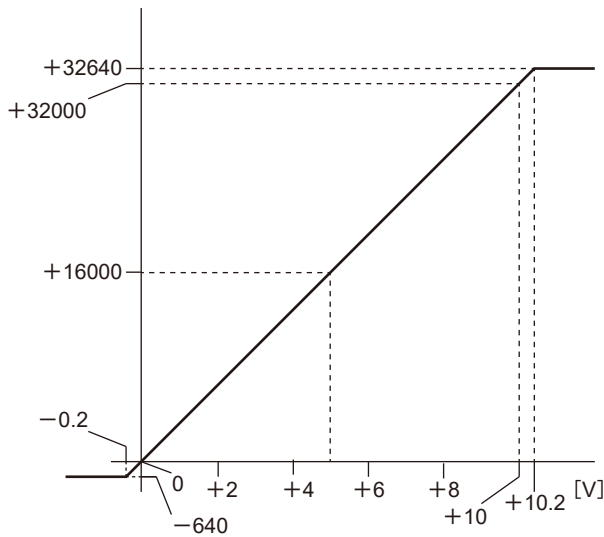

**Input range: 0 to +10 V**

Analog input value (V)	Digital converted value
+10	+32000
+8	+25600
+6	+19200
+4	+12800
+2	+6400
0	0

**When exceeding the rated range**

Analog input value	Converted value
+10.2 V or more	+32640
-0.2 V or less	-640

**7.1.3 Voltage Input Range: -5 to +5 V (Resolution: 1/64,000)**

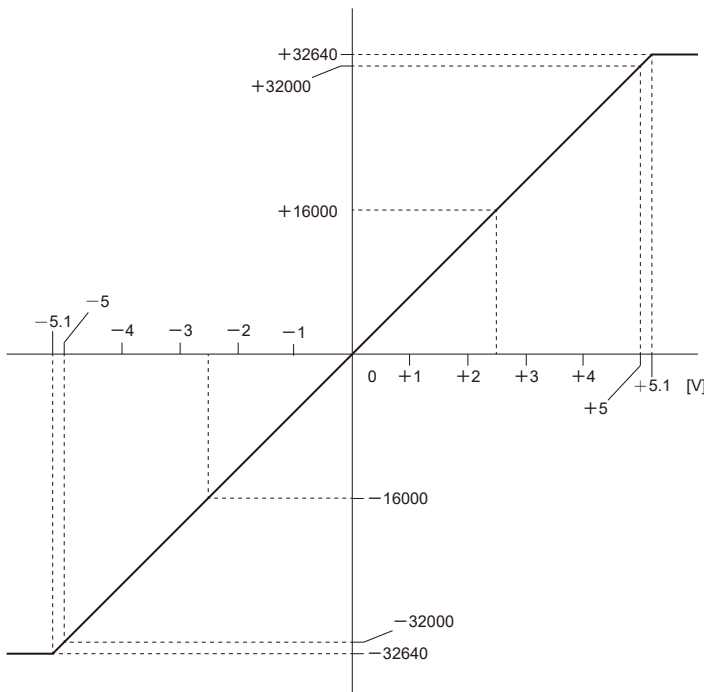

**Input range: -5 to +5 V**

Analog input value (V)	Digital converted value
+5	+32000
+4	+25600
+3	+19200
+2	+12800
+1	+6400
0	0
-1	-6400
-2	-12800
-3	-19200
-4	-25600
-5	-32000

## 7.1 Voltage Range

### When exceeding the rated range

Analog input value	Converted value
+5.1 V or more	+32640
-5.1 V or less	-32640

### 7.1.4 Voltage Input Range: 0 to +5 V (Resolution: 1/32,000)

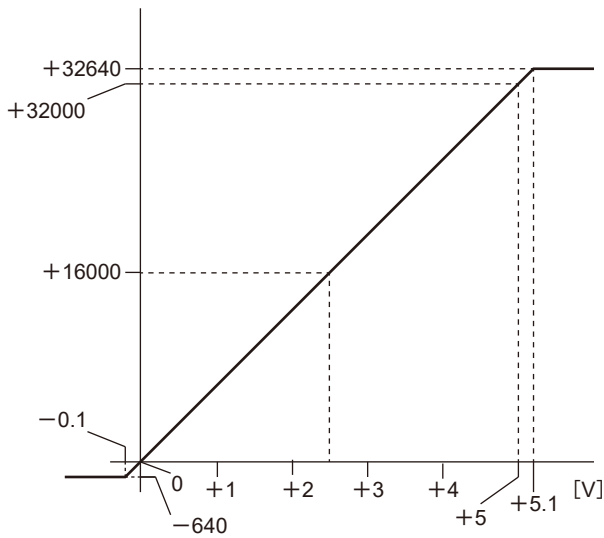

### Input range: 0 to +5 V

Analog input value (V)	Digital converted value
+5	+32000
+4	+25600
+3	+19200
+2	+12800
+1	+6400
0	0

### When exceeding the rated range

Analog input value	Converted value
+5.1 V or more	+32640
-0.1 V or less	-640

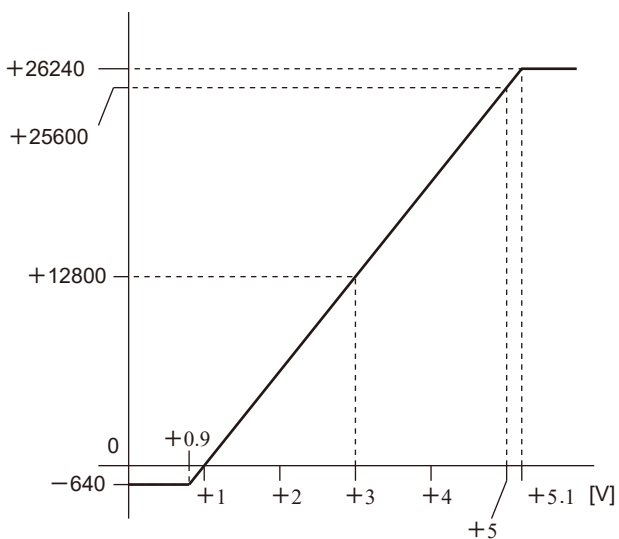

**7.1.5 Voltage Input Range: +1 to +5 V (Resolution: 1/25,600)**

**Input range: +1 to +5 V**

Analog input value (V)	Digital converted value
+5	+25600
+4	+19200
+3	+12800
+2	+6400
+1	0

**When exceeding the rated range**

Analog input value	Converted value
+5.1 V or more	+26240
+0.9 V or less	-640

## 7.2 Current Range

### 7.2 Current Range

#### 7.2.1 Current Input Range: 0 to +20 mA (Resolution: 1/32,000)

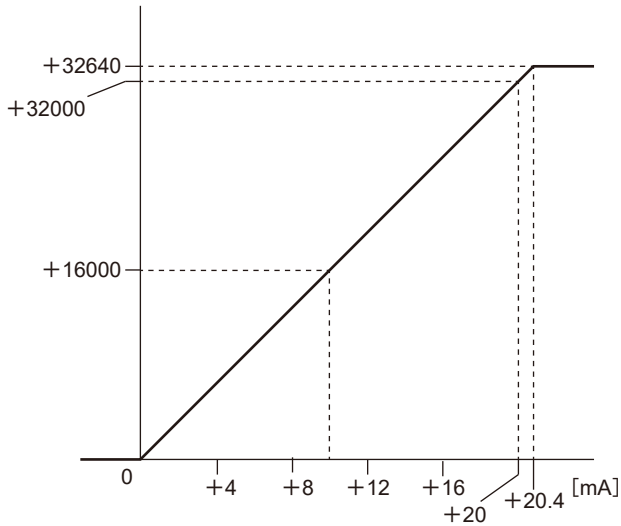

Input range: 0 to +20 mA

Analog input value (mA)	Digital converted value
+20	+32000
+16	+25600
+12	+19200
+8	+12800
+4	+6400
0	0

When exceeding the rated range

Analog input value	Converted value
+20.4 mA or more	+32640
0 mA or less	0

#### 7.2.2 Current Input Range: +4 to +20 mA (Resolution: 1/25,600)

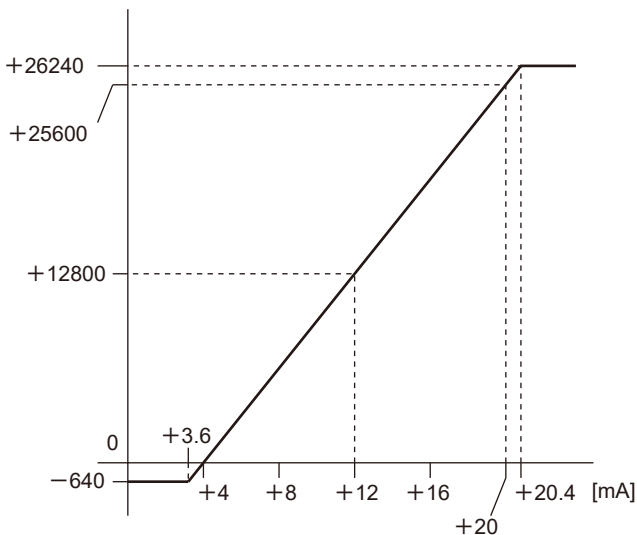

Input range: +4 to +20 mA

Analog input value (mA)	Digital converted value
+20	+25600
+16	+19200
+12	+12800
+8	+6400
+4	0

When exceeding the rated range

Analog input value	Converted value
+20.4 mA or more	+26240
+3.6 mA or less	-640

# 8 Conversion Characteristics of Analog Output

---

8.1 Voltage Range .....	8-2
8.1.1 Voltage Output Range: -10 to +10 V (Resolution: 1/64,000).....	8-2
8.1.2 Voltage Output Range: 0 to +10 V (Resolution: 1/32,000).....	8-3
8.1.3 Voltage Output Range: -5 to +5 V (Resolution: 1/64,000).....	8-3
8.1.4 Voltage Output Range: 0 to +5 V (Resolution: 1/32,000).....	8-4
8.1.5 Voltage Output Range: +1 to +5 V (Resolution: 1/25,600).....	8-4
8.2 Current Range .....	8-6
8.2.1 Current Output Range: 0 to +20 mA (Resolution: 1/32,000).....	8-6
8.2.2 Current Output Range: +4 to +20 mA (Resolution: 1/25,600).....	8-6

## 8.1 Voltage Range

### 8.1 Voltage Range

#### 8.1.1 Voltage Output Range: -10 to +10 V (Resolution: 1/64,000)

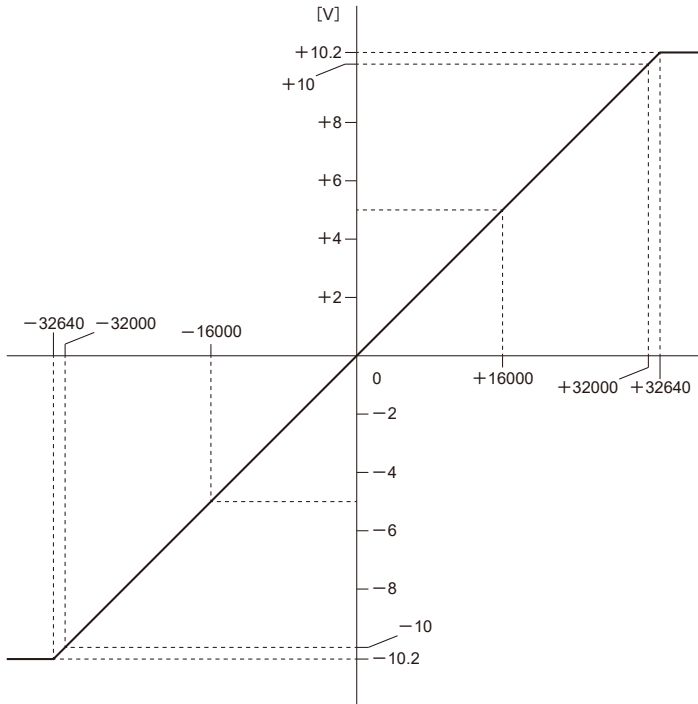

#### Output range: -10 to +10 V

Digital input value	Analog output value (V)
+32000	+10
+25600	+8
+19200	+6
+12800	+4
+6400	+2
0	0
-6400	-2
-12800	-4
-19200	-6
-25600	-8
-32000	-10

#### When exceeding the rated range

Digital input value	Analog output value
+32,640 or more	+10.2 V
-32,640 or less	-10.2 V

**8.1.2 Voltage Output Range: 0 to +10 V (Resolution: 1/32,000)**

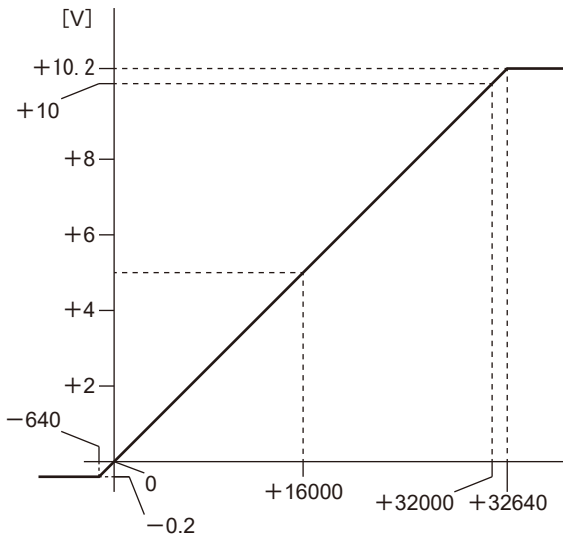

**Output range: 0 to +10 V**

Digital input value	Analog output value (V)
+32000	+10
+25600	+8
+19200	+6
+12800	+4
+6400	+2
0	0

**When exceeding the rated range**

Digital input value	Analog output value
+32640 or more	+10.2 V
-640 or less	-0.2 V

**8.1.3 Voltage Output Range: -5 to +5 V (Resolution: 1/64,000)**

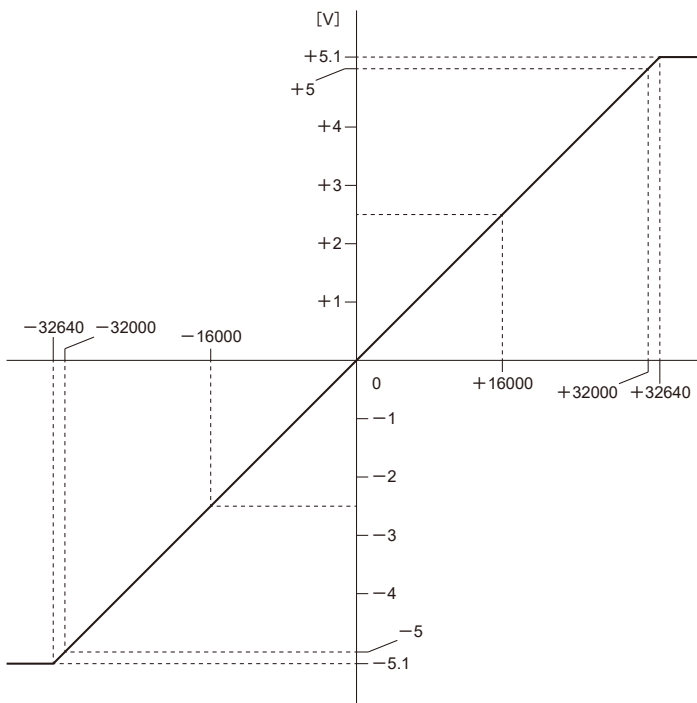

**Output range: -5 to +5 V**

Digital input value	Analog output value (V)
+32000	+5
+25600	+4
+19200	+3
+12800	+2
+6400	+1
0	0
-6400	-1
-12800	-2
-19200	-3
-25600	-4
-32000	-5

**When exceeding the rated range**

Digital input value	Analog output value
+32640 or more	+5.1 V

## 8.1 Voltage Range

Digital input value	Analog output value
-32640 or less	-5.1 V

### 8.1.4 Voltage Output Range: 0 to +5 V (Resolution: 1/32,000)

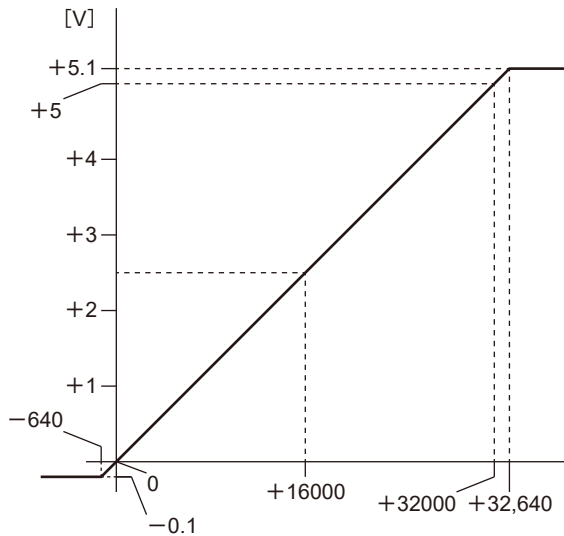

Output range: 0 to +5 V

Digital input value (K)	Analog output value (V)
+32000	+5
+25600	+4
+19200	+3
+12800	+2
+6400	+1
0	0

When exceeding the rated range

Digital input value	Analog output value
+32640 or more	+5.1 V
-640 or less	-0.1 V

### 8.1.5 Voltage Output Range: +1 to +5 V (Resolution: 1/25,600)

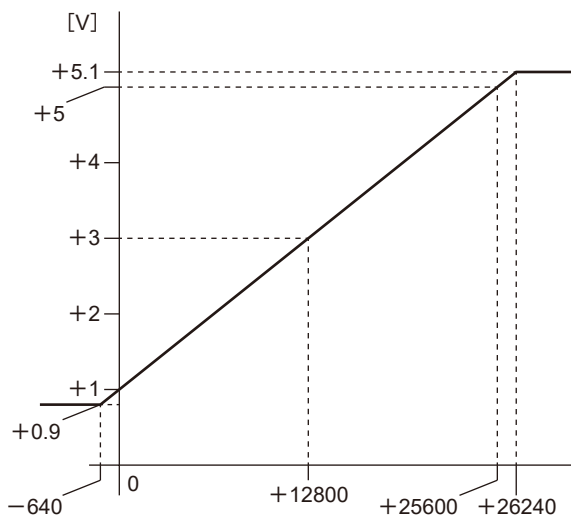

Output range: +1 to +5 V

Digital input value (K)	Analog output value (V)
+25600	+5
+19200	+4
+12800	+3
+6400	+2
0	+1

When exceeding the rated range

Digital input value	Analog output value
+26,240 or more	Output at +5.1 V

## 8.1 Voltage Range

---

Digital input value	Analog output value
-640 or less	Output at +0.9 V

## 8.2 Current Range

### 8.2 Current Range

#### 8.2.1 Current Output Range: 0 to +20 mA (Resolution: 1/32,000)

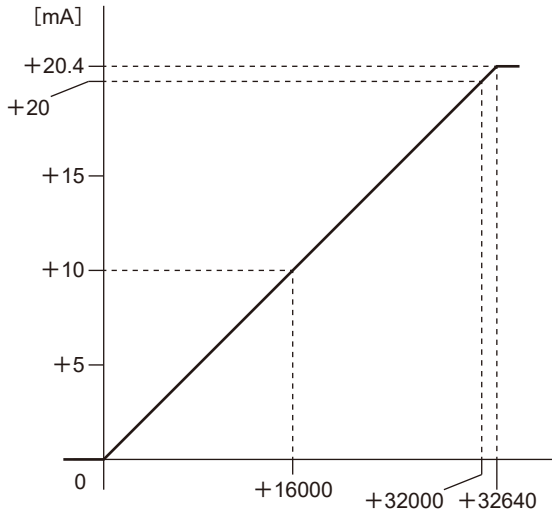

**Output range: 0 to +20 mA**

Digital input value	Analog output value (mA)
+32000	+20
+25600	+16
+19200	+12
+12800	+8
+6400	+4
0	0

**When exceeding the rated range**

Digital input value	Analog output value
+32,640 or more	+20.4 mA
-0 or less	0 mA

#### 8.2.2 Current Output Range: +4 to +20 mA (Resolution: 1/25,600)

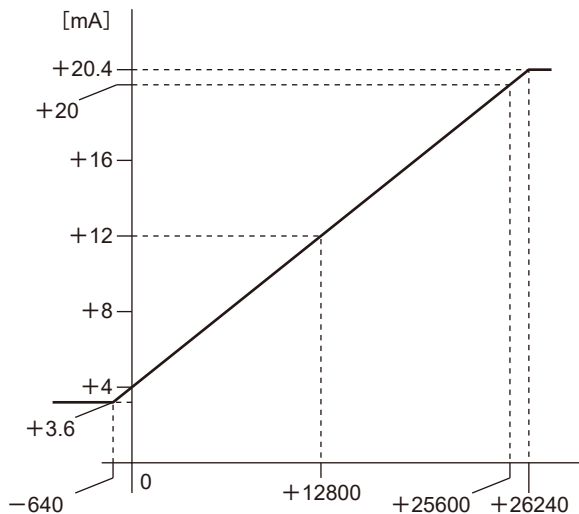

**Output range: +4 to +20 mA**

Digital input value (K)	Analog output value (mA)
+25600	+20
+19200	+16
+12800	+12
+6400	+8
0	+4

**When exceeding the rated range**

Digital input value	Analog output value
+26,240 or more	+20.4 mA
-640 or less	+ 3.6 mA



# 9 What to Do If an Error Occurs

---

9.1 What to Do If an Error Occurs (Analog Input).....	9-2
9.1.1 Failure in Reading Analog Input Data .....	9-2
9.1.2 Unstable Analog Input Values .....	9-2
9.1.3 No Proper Conversion Values Obtained with Current Input.....	9-2
9.2 What to Do If an Error Occurs (Analog Output) .....	9-3
9.2.1 Unstable Analog Output Value .....	9-3
9.2.2 Unchanged Analog Output Value .....	9-3

## 9.1 What to Do If an Error Occurs (Analog Input)

---

### 9.1 What to Do If an Error Occurs (Analog Input)

#### 9.1.1 Failure in Reading Analog Input Data

■ **Situation**

There is a failure in reading analog input data.

■ **Solution**

1. Check again that I/O mapping allocations are correct.
2. Check again the connections of the terminal block.
3. Check again the parameter settings.

#### 9.1.2 Unstable Analog Input Values

■ **Situation**

The analog input value is not stable.

■ **Solution**

1. Check that a twisted pair shield wire is used and that the wire is properly shielded.
2. Check that the analog input wiring is not placed close to AC lines or high-tension lines or bundled with the lines.
3. Check that there are no power lines, high-tension lines, high-capacity relays, or noise-generating equipment, such as inverters, close to the analog input unit.
4. Check that the voltage or current for the range setting is set correctly.

#### 9.1.3 No Proper Conversion Values Obtained with Current Input

■ **Situation**

Proper conversion values cannot be obtained with current input.

■ **Solution**

1. Check again the connections of the terminal block.
2. Check again the connections of the output equipment.
3. Check that the range setting is the current mode.

### 9.2 What to Do If an Error Occurs (Analog Output)

#### 9.2.1 Unstable Analog Output Value

■ **Situation**

The analog output value is not stable.

■ **Solution**

1. Check if the shielded wire of the input device is grounded.  
However, depending on the conditions of the external noise, it may be better not to ground the shielding.
2. Review the program again.

#### 9.2.2 Unchanged Analog Output Value

■ **Situation**

The analog output value remains unchanged.

■ **Solution**

1. Check that the unit is in the RUN mode.
2. Check again that I/O allocations are correct.
3. Check again the connections of the terminal block.
4. Check that the impedance of the input device is 500  $\Omega$  or below if the current output range is set.
5. Check that the output is not short-circuited.
6. Check that the digital input value is within the range.
7. Check the parameter settings.

(MEMO)

# 10 Specifications

---

10.1 General Specifications .....	10-2
10.2 Performance Specifications .....	10-3
10.2.1 Input Specifications of the Analog Input Unit .....	10-3
10.2.2 Output Specifications of the Analog Output Unit.....	10-4
10.3 Dimensions .....	10-6
10.3.1 Analog I/O Unit.....	10-6

## 10.1 General Specifications

### 10.1 General Specifications

Item	Specifications	
Operating ambient temperature	0°C to +55°C	
Storage ambient temperature	-40°C to +70°C	
Operating ambient humidity	10% to 95% (RH) (at 25°C, no condensation)	
Storage ambient humidity	10% to 95% (RH) (at 25°C, no condensation)	
Withstand voltage	Between analog terminals and power supply terminals of the GM1 Controller/function earth terminals	500 V AC for 1 minute
Insulation resistance	Between analog terminals and power supply terminals of the GM1 Controller/function earth terminals	100 MΩ or later
Vibration resistance	Conforming to JIS B 3502 and IEC 61131-2 5 to 8.4 Hz, 3.5-mm single amplitude 8.4 to 150 Hz, acceleration 9.8 m/s <sup>2</sup> 10 sweeps each in X, Y, and Z directions (1 octave/min.)	
Shock resistance	Conforming to JIS B 3502 and IEC 61131-2 147 m/s <sup>2</sup> , 3 times each in the X, Y, Z directions	
Noise resistance	1000 V [p-p] with pulse widths of 50 ns/1 μs (by using a noise simulator) (Applied to the power supply of the GM1 Controller)	
Atmosphere	Free of corrosive gases. No excessive dust.	
European EU Standards	EMC : EN 61131-2 RoHS : EN IEC 63000	
Overtoltage category	Category II	
Pollution degree	2	

## 10.2 Performance Specifications

### 10.2.1 Input Specifications of the Analog Input Unit

#### ■ Input specifications

Item		Specifications
No. of input points		8 ch
Input range (resolution)	Voltage	-10 to +10 V DC (Resolution: 1/64,000) 0 to +10 V DC (Resolution: 1/32,000) -5 to +5 V DC (Resolution: 1/64,000) 0 to +5 V DC (Resolution: 1/32,000) +1 to +5 V DC (Resolution: 1/25,600) <sup>(Note 1)</sup>
	Current	0 to +20 mA (Resolution: 1/32,000) +4 to +20 mA (Resolution: 1/25,600) <sup>(Note 1)</sup>
Conversion speed		50 $\mu$ s/ch
Exceeding the rated range		Input is possible up to $\pm 2\%$ of the input range <sup>(Note 2)</sup>
Total accuracy		$\pm 0.2\%$ F.S. or less (at +25°C) $\pm 0.4\%$ F.S. or less (at 0 to +55°C)
Input impedance		Voltage input: Approximately 1 M $\Omega$ ; current input: Approximately 250 $\Omega$
Absolute max. input		Voltage input: -15 V to +15 V; current input: -30 mA to +30 mA
Insulation method		Between input terminals and internal circuit: Photocoupler and isolated DC/DC converter Between channels: Non-insulated
Execution / Non-execution channel settings		Possible to make non-converted channel settings.
Input range selection		Possible to make settings on a channel-by-channel basis
Average processing	Number of averaging times	Setting range of 2 to 60,000 times
	Time average	Time setting range of 1 to 1,500 ms
	Moving average	Setting range of 2 to 2,000 times
Offset / Gain settings		A desired value within the digital output range can be set for the offset value. Setting range: -3000 to +3000 A desired value within the digital output range can be set for the gain value. Setting range: +9,000 to +11,000 (90% to 110%)
Scale conversion settings		A desired value within the digital output range can be set for the scale conversion setting value. Setting range: -32768 to +32767
Upper limit / lower limit comparison		Output if the value is outside the preset upper limit or lower limit. Setting range: -32768 to +32767
Max. / Min. hold		Holding max. / min. values sampled

## 10.2 Performance Specifications

Item	Specifications
Disconnection detection	Disconnection detection is possible for the following ranges. Possible to select auto or manual resetting <ul style="list-style-type: none"> <li>• 1 to 5 V range (Detection level: 0.7 V or less)</li> <li>• 4 to 20 mA range (Detection level: 2.8 mA or less.)</li> </ul>

(Note 1) The full scale (F.S.) on the accuracy of an analog voltage input range from +1 to +5 V and that of an analog current input range from +4 to +20 mA are 0 to +5 V and 0 to +20 mA, respectively.

(Note 2) If a value that exceeds the input range  $\pm 2\%$  is entered, it will be rounded to the input range  $\pm 2\%$ . However, 0 to 20.4 mA is possible in the 0 to 20 mA range.

### 10.2.2 Output Specifications of the Analog Output Unit

#### ■ Output specifications

Item	Specifications																		
No. of output points	4ch																		
Output range (resolution) <sup>(Note 1)</sup>	<table border="1"> <thead> <tr> <th>Voltage</th> <th>Specifications</th> </tr> </thead> <tbody> <tr> <td></td> <td>-10 to +10 V DC (Resolution: 1/64,000)</td> </tr> <tr> <td></td> <td>0 to +10 V DC (Resolution: 1/32,000)</td> </tr> <tr> <td></td> <td>-5 to +5 V DC (Resolution: 1/64,000)</td> </tr> <tr> <td></td> <td>0 to +5 V DC (Resolution: 1/32,000)</td> </tr> <tr> <td></td> <td>+1 to +5 V DC (Resolution: 1/25,600)</td> </tr> <tr> <th>Current</th> <th>Specifications</th> </tr> <tr> <td></td> <td>0 to +20 mA (Resolution: 1/32,000)</td> </tr> <tr> <td></td> <td>+4 to +20 mA (Resolution: 1/25,600)</td> </tr> </tbody> </table>	Voltage	Specifications		-10 to +10 V DC (Resolution: 1/64,000)		0 to +10 V DC (Resolution: 1/32,000)		-5 to +5 V DC (Resolution: 1/64,000)		0 to +5 V DC (Resolution: 1/32,000)		+1 to +5 V DC (Resolution: 1/25,600)	Current	Specifications		0 to +20 mA (Resolution: 1/32,000)		+4 to +20 mA (Resolution: 1/25,600)
Voltage	Specifications																		
	-10 to +10 V DC (Resolution: 1/64,000)																		
	0 to +10 V DC (Resolution: 1/32,000)																		
	-5 to +5 V DC (Resolution: 1/64,000)																		
	0 to +5 V DC (Resolution: 1/32,000)																		
	+1 to +5 V DC (Resolution: 1/25,600)																		
Current	Specifications																		
	0 to +20 mA (Resolution: 1/32,000)																		
	+4 to +20 mA (Resolution: 1/25,600)																		
Conversion speed	50 $\mu$ s/4ch																		
Exceeding the rated range	Output is possible up to $\pm 2\%$ of the output range <sup>(Note 2)</sup>																		
Total accuracy	$\pm 0.2\%$ F.S. or less (at +25°C) $\pm 0.4\%$ F.S. or less (at 0 to +55°C)																		
Output impedance (voltage output)	0.5 $\Omega$ or less																		
Maximum output current (voltage output)	10 mA																		
Output allowable load resistance (current output)	500 $\Omega$ or less																		
Insulation method	Between output terminals and internal circuit: Photocoupler and isolated DC/DC converter Between channels: Non-insulated																		
Conversion execution / non-execution channel settings	Possible to make non-converted channel settings.																		
Clipping function	Upper and lower output limits can be set for digital input values. Setting range: -32,640 to +32,640																		
Scale conversion settings	A desired value within the digital input range can be set for the scale conversion setting value. Setting range: -32768 to +32767																		
Offset / Gain settings	A desired value within the digital input range can be set for the offset value.																		



## 10.2 Performance Specifications

---

Item	Specifications
	Setting range: -3,000 to +3,000 A desired value within the digital input range can be set for the gain value. Setting range: +9,000 to +11,000 (90% to 110%)
Analog output hold (in STOP mode)	A desired output value while in STOP mode can be set as a digital value. Setting range: -32640 to +32640

(Note 1) The full scale (F.S.) on the accuracy of an analog voltage output range from +1 to +5 V and that of an analog current output range from +4 to +20 mA are 0 to +5 V and 0 to +20 mA, respectively.

(Note 2) If a value exceeding the output range  $\pm 2\%$  is set, the output will be rounded to the output range  $\pm 2\%$ . However, 0 to 20.4 mA is possible in the 0 to 20 mA range.

# 10.3 Dimensions

## 10.3 Dimensions

### 10.3.1 Analog I/O Unit

Applicable model: AGM1AD8 and AGM1DA4

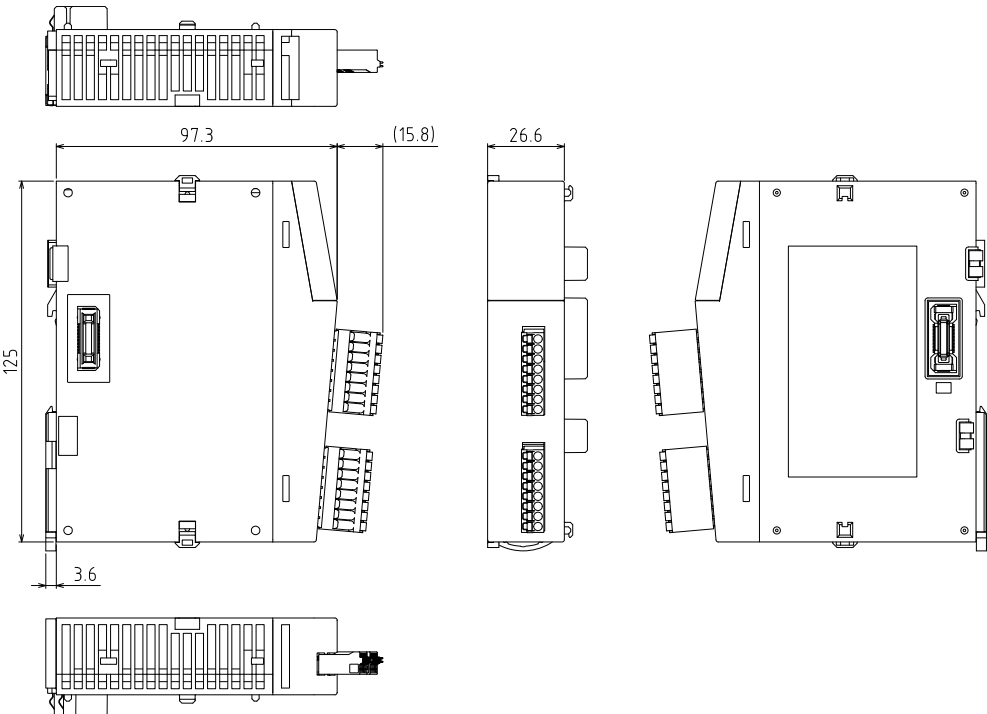

Unit: mm

# Appendix Warranty / Cautions for Proper Use

---

Warranty .....	App-2
Warranty Period .....	App-2
Warranty Scope .....	App-2
Cautions for Proper Use .....	App-3

# Warranty

---

## Warranty

### Warranty Period

Warranty period shall be 12 months from the ex-factory date or 18 months from the date of manufacturing.

This Warranty shall be exempted in the following cases,

1. Defects resulting from misuse and/or repair or modification by the customer.
2. Defects resulting from drop of the Product or damage during transportation.
3. Defects resulting from improper usage of the Product beyond the Specifications.
4. Defects resulting from fire, earthquake, lightening, flood, damage from salt, abnormal voltage or other Act of God, or other disaster.
5. Defects resulting from the intrusion of foreign material to the Product, such as water, oil or metallic particles.

Parts exceeding their standard lifetime specified in this document are excluded.

### Warranty Scope

Panasonic warrants the replacement of the defected parts of the Product or repair of them when the defects of the Product occur during the Warranty Period, and when the defects are under Panasonic responsibility. This Warranty only covers the Product itself and does not cover any damage incurred by such defects.

Panasonic in accordance with 'Warranty Period' records, in any case, the machine state is poor, and cause damage to your company and the third party, all liability, Panasonic is not responsible.

1. The machines are not assembled in accordance with the instructions or precautions noted in this specification.
2. When the machine does not match the product assembled in the machine.
3. This specification does not depend on your company.
4. When the machine condition is not caused by Panasonic reasons.

### Cautions for Proper Use

- Practical considerations for exporting the product or assembly containing the product  
When the end user of the product or end use of the product is associated with military affair or weapon, its export may be controlled by the Foreign Exchange and Foreign Trade Control Law. Complete review of the product to be exported and export formalities should be practiced.
- This product is intended to be used with a general industrial product, but not designed or manufactured to be used in a machine or system that may cause personal death when it is failed.
- Installation, wiring, operation, maintenance, etc., of the equipment should be done by qualified and experienced personnel.
- Install a safety equipments or apparatus in your application, when a serious accident or loss of property is expected due to the failure of this product.
- This product is designed for general industrial equipments. Don't use this product under special conditions such as nuclear energy control, aerospace equipments, transportation, medical equipment, various safety equipments or special equipments.
- The wiring condition(earth wire method and cables length and shield cable condition of signal lines) may affect the noise resistance, please confirm the noise resistance of the machine.
- Failure of this product depending on its content, may generate smoke of about one cigarette. Take this into consideration when the application of the machine is clean room related.
- Product overload can cause the goods to fall, please follow the marking.
- Do not use benzine, thinner, alcohol, acidic cleaner and alkaline cleaner because they can discolor or damage the exterior case.
- This product shall be treated as industrial waste when you dispose.
- This product related standards, laws and the user is responsible for matching between machine and components in terms of configuration, dimensions, life expectancy, characteristics, when installing the machine or changing specification of the machine. The user is also responsible for complying with applicable laws and regulations.
- The product will not be guaranteed when it is used outside its specification limits.
- Parts are subject to minor change to improve performance.

(MEMO)

## Record of Changes

Date	Manual No.	Record of changes
August 2021	WUME-GM1AIO-01	1st edition
April 2022	WUME-GM1AIO-02	2nd edition <ul style="list-style-type: none"><li>• Changed the Company name</li></ul>
June 2022	WUME-GM1AIO-03	3rd edition <ul style="list-style-type: none"><li>• Clerical corrections</li></ul>

(MEMO)



(MEMO)

---

Please contact .....

**Industrial Device Business Division,  
Panasonic Industry Co., Ltd.**

7-1-1 Morofuku, Daito City, Osaka, 574-0044, Japan  
[industrial.panasonic.com/ac/e/](http://industrial.panasonic.com/ac/e/)

© Panasonic Industry Co., Ltd 2021-2022

WUME-GM1AIO-03