

Document No. : SX-DSV03241

---

Revision No. : R11.0

---

Date of Issue : Apr. 28, 2022

---

Classification :  New  Change

---

# Technical Reference

## - Functional Specification -

Product Name : AC Servo Driver

Product Series Name : MINAS A6B series

Product Model Number : EtherCAT communication/rotation type

Motion Control Business Unit, Industrial Device Business Division  
Panasonic Industry Co., Ltd.  
7-1-1 Morofuku, Daito—City, Osaka 574-0044, Japan

If you have any questions, please contact the seller (Sales office or Distributor) of the product.

**Panasonic**

この英文仕様書は、原本である和文仕様書を元にパナソニック インダストリー株式会社  
モーションコントロールビジネスユニットが翻訳・発行するものです。

翻訳は、原本の利用に際して一応の参考となるように便宜的に仮訳したものであり、公的な  
校閲を受けたものではありません。英語訳のみを使用して生じた不都合な事態に関しては、  
当社は一切責任を負うものではありません。和文仕様書のみが有効です。

パナソニック インダストリー株式会社  
産業デバイス事業部 モーションコントロールビジネスユニット

This English specification is made and published by Motion Control Business Unit, Panasonic Industry Co., Ltd. based on the original Japanese specification. Translation is provided unofficially only for the sake of convenience of utilizing the original Japanese specification as a measure of reference. It is not officially reviewed. Motion Control Business Unit, Panasonic Industry Co., Ltd. is not liable for any disadvantages caused by utilizing only English specification. Only the Japanese specification is effective.

Motion Control Business Unit, Industrial Device Business Division,  
Panasonic Industry Co., Ltd.

# Revisions

Date	Page	Rev.	Description	Signed
Jun.6, 2017	-	1.0	First edition	-
Nov.17, 2017	P1,2	2.0	<ul style="list-style-type: none"> <li>• Software upgrade CPU1 Ver1.01 → Ver1.02</li> <li style="padding-left: 20px;">CPU2 Ver1.01 → Ver1.02</li> </ul>	-
	(No change in this document)		1) Function addition "Serial number range expansion"	
	(No change in this document)		2) Function addition "Safety function"	
	P1,2,37,38,54, 96,106,111,132, 147,189,190,212, 217,225		3) Function addition "Full-closed control"	
	P224		4) Function addition "Hybrid vibration damping function"	
	P25		5) Function addition "External scale position information monitor function under semi-closed control "	
	P1,9,10,18,19 23,36,47,52 166-171,173, 175,185,227,233		6) Function addition "Retracting operation function"	
	P37,172,179		7) Function addition "Change of the attribute of Making Err 27.4 (Command error protection) to clearable"	
	P13		8) Function addition "Servo information monitor object function expansion"	
	P159,186		9) Function addition "Err 91.1 (Command error protection) for the out-of-range target position setting in the continuous rotating absolute encoder mode"	
	P172,179		10) Function addition "Err 27.7 (Position information initialization error protection) at the time of return to origin cancellation"	
	P222,225		• Change Changed the attribute of Pr5.31 and Pr6.38 from R to C	
	P231		• Change Changed the attribute of Pr7.24_bit0 and bit11 from R to C Deleted notes on Pr7.24_bit0 and bit11	
	P14		• Correction Modified the description of notes *5) "Communication re-established"	
	P55		• Correction Modified the figures showing the counting direction of driver internal processing on the A, B phase output type external scale	
	P123		• Correction Modified the description of Pr6.42 Modified the description of two-stage torque filter (4) How to use	
	P147		• Correction Modified the description of the slow stop function	
	P156		• Correction Modified the figures of Single-turn absolute function (5) Operation example	
	P158,228		• Correction Modified the description of Pr6.88	
	P179,186		• Correction / addition Modified and added the causes of and measures taken with respect to Err27.4, Err29.1, Err29.2, Err88.1, and Err91.1	
	P173,189		• Correction Corrected the erroneous description of the title of Err91.1	

Note: The page number (Page) is the current page number at the time of revision.

# Revisions

Date	Page	Rev.	Description	Signed
			(Continued from previous page)	
	P218		• Correction Modified the related chapter numbers with respect to Pr4.37 to Pr4.39	
	P229		• Correction Modified the description of Pr7.16	
	P198		• Deletion Removed the notes on the warning D2	
	P152		• Addition Added notes on the position comparison function	
	P232		• Addition Added Pr7.101 to Pr7.104 (For manufacturer's use) and Pr7.110 (For manufacturer's use)	
Jan.23, 2018	P14,176	2.1	• Correction Corrected the erroneous description	-
Mar.16, 2018	P1,3	3.0	• Software upgrade CPU1 Ver1.02 → Ver1.03 CPU2 Ver1.02 → Ver1.03	-
	(No change in this document)		1) Function addition "Servo information monitor object function expansion"	
Oct.26, 2018	P1,3	4.0	• Software upgrade CPU1 Ver1.03 → Ver1.05 CPU2 Ver1.03 → Ver1.05	-
	P56,60-65,67,71, 178,187,192,223, 233,242		1) Function addition "Full-closed control function (Rotary scale)"	
	P101-104,133, 135,138,153,238		2) Function addition "Torque offset filter"	
	P101-104,133, 135,138		3) Function addition "Torque control function in velocity control loop"	
	(No change in this document)		4) Function addition "Velocity integral value clear function"	
	P6-9,234,235		5) Function addition "Backlash compensation function"	
	P233		6) Function addition "hm operation specification extension"	
	P145,226		7) Function change "Extension of Pr5.09 (Main power supply off detection period) setup range"	
	P90,103,191		8) Function addition "Torque control under two-degrees-of-freedom control"	
	P128,230		9) Function change "Extension of Pr6.35 (Hybrid vibration suppression filter) setup range"	
	P105,236		10) Function addition "High response current control"	
	P105-108,137,139, 142,143,234,241		11) Function addition "Response to EtherCAT object extension" • Torque limit function extension • Velocity limit function extension during torque control	
	P176,177,179, 181,188		12) Function addition "Retracting operation specification extension"	
	P244		13) Function addition "Absolute data specification extension"	
	P4,6		• Addition Added the description about G-frame and H-frame	
	P12,13,14		• Addition Description copied from technical reference EtherCAT communication specification	

Note: The page number (Page) is the current page number at the time of revision.

# Revisions

Date	Page	Rev.	Description	Signed
			(Continued from previous page)	
Mar.20, 2019	P1,4,12,13	5.0	<ul style="list-style-type: none"> <li>• Software upgrade CPU1 Ver1.05 → Ver1.06</li> <li style="padding-left: 20px;">CPU2 Ver1.05 → Ver1.06</li> </ul>	-
	P195,201,252		1) Function addition “hm operation specification extension” <ul style="list-style-type: none"> <li>• Homing in the absolute mode is supported.</li> </ul>	
	P247		2) Function addition “Torque monitor value accuracy improvement”	
Apr.30, 2019	P1,4,5	6.0	<ul style="list-style-type: none"> <li>• Software upgrade CPU1 Ver1.06 → Ver1.07</li> <li style="padding-left: 20px;">CPU2 Ver1.06 → Ver1.07</li> </ul>	-
	P5,14,147,204		1) Function addition “Torque control can be switched when 2 degrees of freedom control mode (synchronization type) is selected”	
	P5		2) Function addition “EtherCAT communication cycle 8ms, 10ms extension”	
	P2,4,7,21,73-75, 199,205,219-220		• Addition Compatible with the battery-less absolute encoder	
	P13,171,175,177,197, 205,219,226,233,243		<ul style="list-style-type: none"> <li>• Added the description</li> <li>• Corrected incorrect entries.</li> </ul>	
	Overall		• Company name changed.	
Mar.27, 2020	P7,12,167	6.1	• Corrected incorrect entries.	-
May 12, 2020	P1,5,13,14	7.0	<ul style="list-style-type: none"> <li>• Software upgrade CPU1 Ver1.07 → Ver1.08</li> <li style="padding-left: 20px;">CPU2 Ver1.07 → Ver1.08</li> </ul>	-
	P152,154,193,206,21 9,221,252,253		1) Function addition “Specification extension of over-travel inhibition input”	
	P152,193		• Added notes	
Sep.14, 2020	P1,6,15-17	8.0	<ul style="list-style-type: none"> <li>• Software upgrade CPU1 Ver1.08 → Ver1.09</li> <li style="padding-left: 20px;">CPU2 Ver1.08 → Ver1.09</li> </ul>	-
	P61,258		1) Function addition “Velocity limit priority function during torque control”	
	P258		2) Function addition “Specification extension of Touch Probe function”	
	(No changes to this document)		3) Function addition “Target position echo function”	
	P38,39,246		• Change: Changed the setting range of Pr4.16 and Pr4.18 to 0-30.	
	P7,14,20,37,154,157, 170,174,199,260,261		<ul style="list-style-type: none"> <li>• Added the description</li> <li>• Corrected incorrect entries.</li> </ul>	
Jun.1, 2021	P1,6,16,17	9.0	<ul style="list-style-type: none"> <li>• Software upgrade CPU1 Ver1.09 → Ver1.10</li> <li style="padding-left: 20px;">CPU2 Ver1.09 → Ver1.10</li> </ul>	-
	P8,9,10,30,31,33, 34,36,37,39,43,75, 160,173,188,197,201, 224,241,247-250, 261,262		1) Function addition “V frame supported”	
	P17,194-196,261,262		2) Function addition “Specification extension of backlash compensation function”	

Note: The page number (Page) is the current page number at the time of revision.

# Revisions

Date	Page	Rev.	Description	Signed
			(Continued from previous page)	
	P17,201,214		3) Function addition "External scale Z-phase latch function during semi-closed control"	
	P1,6,7,9,10,17,34, 55,156,225,227, 241,246,247,250, 254,259,260,261		<ul style="list-style-type: none"> <li>Added the description</li> <li>Corrected incorrect entries.</li> </ul>	
	Overall		<ul style="list-style-type: none"> <li>Corrected all incorrect entries.</li> <li>Company name changed.</li> </ul>	
Dec.1.2021	P1,6,16-17	10.0	<ul style="list-style-type: none"> <li>Software upgrade CPU1 Ver1.10 → Ver1.12</li> <li>CPU2 Ver1.10 → Ver1.12</li> </ul>	-
	P263,264		<ul style="list-style-type: none"> <li>Improved EtherCAT communication compatibility</li> <li>Addition Added Pr7.24 bit15 (For manufacturer's use)</li> <li>Addition Added Pr7.87 bit14-15 (For manufacturer's use)</li> </ul>	
	Overall		<ul style="list-style-type: none"> <li>Company name changed.</li> <li>Corrected incorrect entries.</li> </ul>	
Apr. 1, 2022	-	10.1	<ul style="list-style-type: none"> <li>Changed the company name</li> </ul>	-
	-		<ul style="list-style-type: none"> <li>Changed the front cover format</li> </ul>	
Apr. 28, 2022	P1,6,16-18	11.0	<ul style="list-style-type: none"> <li>Software upgrade CPU1 Ver1.12 → Ver1.13</li> <li>CPU2 Ver1.12 → Ver1.13</li> </ul>	-
	P6,264		<ul style="list-style-type: none"> <li>1) Function addition "Specification extension of Statusword"</li> <li>Addition Added Pr7.87 bit13</li> </ul>	
	P6		<ul style="list-style-type: none"> <li>2) Function addition "Extension of hm operation specification"</li> <li>The origin returns using the mechanical end is supported.</li> </ul>	
	P253,255		<ul style="list-style-type: none"> <li>Addition Added Pr5.96 and Pr5.97 (For manufacturer's use)</li> <li>Addition Added Pr6.25 and Pr6.26 (For manufacturer's use)</li> </ul>	
	P265,266		<ul style="list-style-type: none"> <li>Change Modified the name of Pr7.110</li> <li>Addition Added Pr7.110 bit7-8</li> </ul>	
	P207		<ul style="list-style-type: none"> <li>Addition Added the description about Err80.3</li> </ul>	
	P199,213		<ul style="list-style-type: none"> <li>Addition Added Err98.5</li> </ul>	
	Overall		<ul style="list-style-type: none"> <li>Corrected incorrect entries.</li> </ul>	

Note: The page number (Page) is the current page number at the time of revision.

Contents
----------

<b>1. Introduction.....</b>	<b>1</b>
1-1 Basic Specification .....	9
1-2 Function (Position control) .....	11
1-3 Function (Velocity control).....	12
1-4 Function (Torque control).....	13
1-5 Function (Full-closed control) .....	14
1-6 Function (Common) .....	15
1-7 Main differences from the MINAS-A5B series .....	16
<b>2. Interface Specification .....</b>	<b>19</b>
2-1 I/O connector input signal .....	19
2-2 I/O connector output signal .....	21
2-3 I/O connector other signal .....	24
2-3-1 Encoder output signal / Position comparison output signal .....	24
2-3-2 Others .....	24
2-4 I/O signal allocation function .....	25
2-4-1 Input signal allocation .....	25
2-4-2 Assignment of output signal .....	30
<b>3. Front panel display specification .....</b>	<b>33</b>
3-1 Appearance of front panel.....	33
3-2 7-Segment LED , ALM and SRVON LED .....	34
3-2-1 7 Segment LED .....	34
3-2-2 ALM LED and SRVON LED .....	36
3-3 EtherCAT Indicators .....	36
1) RUN.....	38
2) ERR.....	38
3-4 Monitor signal output function .....	39
3-5 Station alias .....	43
<b>4. Basic function .....</b>	<b>44</b>
4-1 Rotational direction setup .....	44
4-2 Position control.....	45
4-2-1 Process of command pulse input .....	45
4-2-2 Electronic gear function .....	46
4-2-3 Positional command filtering function .....	49
4-2-4 Positioning complete output (INP/INP2) function .....	51
4-2-5 Pulse regeneration function .....	53
4-3 Velocity control .....	56
4-3-1 Attained speed output (AT-SPEED).....	57
4-3-2 Speed coincidence output (V-COIN).....	58
4-3-3 Velocity command acceleration/deceleration setting function.....	59
4-4 Torque control.....	61
4-4-1 Speed limit function .....	62
4-5 Full-closed control .....	63
4-5-1 Selection of external scale type .....	64
4-5-2 Setting of external scale division ratio.....	66
4-5-3 Setting of hybrid deviation excess.....	67
4-5-4 Full-closed control function (Rotary scale) .....	68
4-6 Setting regenerative resistor .....	75
4-7 Absolute setup .....	76
4-7-1 Absolute encoder.....	76
4-7-1-1 Structure of absolute system .....	77
4-7-1-2 Installing battery for absolute data.....	77
4-7-1-3 Clearing of absolute data.....	77
4-7-1-4 Battery refresh for the battery-powered absolute encoder.....	78
4-7-2 External scale .....	79
4-7-2-1 External scale absolute system configuration.....	79
4-8 External scale position information monitor function under semi-closed control.....	80

<b>5. Gain tuning/vibration suppressing function .....</b>	<b>81</b>
5-1 Automatic adjusting function.....	81
5-1-1 Real-Time Auto Tuning .....	82
5-1-2 Adaptive filter.....	90
5-1-3 Real-time Auto Tuning (Two-degree-of-Freedom control mode Standard type) .....	93
5-1-4 Real-time Auto Tuning (Two-degree-of-Freedom control mode Synchronization type) .....	101
5-2 Manual adjusting function .....	109
5-2-1 Block diagram of position control mode .....	110
5-2-2 Block diagram of velocity control mode .....	111
5-2-3 Block diagram of torque control mode.....	112
5-2-4 Block diagram of full-closed control mode .....	113
5-2-5 Gain Switching Function .....	114
5-2-6 Notch filter .....	120
5-2-7 Damping Control.....	122
5-2-8 Model-type damping filter.....	127
5-2-9 Feed forward function .....	131
5-2-10 Load variation suppression function.....	133
5-2-11 3rd gain switching function .....	136
5-2-12 Friction torque compensation .....	137
5-2-13 Hybrid vibration damping function .....	139
5-2-14 Two-stage torque filter .....	140
5-2-15 Quadrant projection suppression function .....	141
5-2-16 Two-degree-of-freedom control mode (with position control) .....	142
5-2-17 Two-degree-of-freedom control mode (with velocity control) .....	145
5-2-18 Two-degree-of-freedom control mode (with Full-closed control) .....	147
5-2-19 Two-degree-of-freedom control mode (with torque control).....	150
5-2-20 High response current control.....	151
<b>6. Application .....</b>	<b>152</b>
6-1 Torque limit switching function.....	152
6-2 Motor working range setup function .....	153
6-3 Deceleration stop sequence.....	155
6-3-1 Sequence upon inputting of over-travel inhibition (POT, NOT).....	155
6-3-2 Sequence at Servo-Off.....	159
6-3-3 Sequence at main power OFF.....	160
6-3-4 Sequence at alarm.....	162
6-3-5 Emergency stop upon occurrence of alarm.....	164
6-3-6 Fall prevention function in the event of alarms/Servo-ON.....	166
6-3-7 Slow stop function.....	168
6-4 Torque saturation protection function .....	171
6-5 Position comparison output function .....	172
6-6 Single-turn absolute function.....	176
6-7 Continuous rotating absolute encoder function.....	179
6-8 Deterioration diagnosis warning function.....	183
6-9 Retracting operation function .....	186
6-10 Backlash compensation function .....	193
<b>7. Protective function/Alarm function.....</b>	<b>197</b>
7-1 List of protective function .....	197
7-2 Details of Protective function .....	201
7-3 Warning function .....	225
7-4 Setup of gain pre-adjustment protection .....	229
7-5 About the protection function setting for homing return by using the Z phase.....	231



<b>8. Safety function .....</b>	<b>233</b>
8-1 Outline of safe torque off (STO) function.....	233
8-2 Input/output signal specification.....	234
8-2-1 Safety input signal .....	234
8-2-2 External device monitor (EDM) output signal .....	235
8-3 Description of functions .....	236
8-3-1 Activation to STO state, timing diagram .....	236
8-3-2 Return timing diagram from STO state .....	237
8-4 Connection example .....	238
8-4-1 Example of connection to safety switch .....	238
8-4-2 Example of connection when using multiple axes.....	239
8-5 Safety precautions .....	240
<b>9. Other .....</b>	<b>241</b>
9-1 List of parameters .....	241
9-1-1 Class 0: Basic setting.....	241
9-1-2 Class 1: Gain adjustment .....	242
9-1-3 Class 2: Damping control .....	244
9-1-4 Class 3: Velocity/ Torque/ Full-closed control.....	246
9-1-5 Class 4: I/O monitor setting.....	247
9-1-6 Class 5: Enhancing setting.....	250
9-1-7 Class 6: Special setting .....	254
9-1-8 Class 7: Special setting 2.....	261
9-1-9 Class 8: Special setting 3.....	267
9-1-10 Class 9: Linear.....	268
9-1-11 Class 15: For manufacturer's use .....	269
9-2 Timing Chart.....	270
9-2-1 Servo-on signal accept timing on power-up .....	270
9-2-2 Servo-ON/OFF action while the motor is at stall (servo-lock) .....	271
9-2-3 Servo-ON/OFF action while the motor is in motion .....	272
9-2-4 When an error (alarm) has occurred (at Servo-ON command) (DB/Free run deceleration movement).....	273
9-2-5 When an error (alarm) has occurred (at Servo-ON command) (Emergency stop movement) .....	274
9-2-6 When an alarm has been cleared (at Servo-ON command) .....	275

## 1. Introduction

This document describes the functions of the servo driver MINAS-A6B series.

<MINAS-A6B series Functional comparison>

\* In this software version, The functions of “×” are not supported in the table below.

The description regarding these functions in the body text may be subject to change without prior notice at handling, hereafter.

○:Usable ×:Not usable

Function		Product	[A6BE] (Standard type) Product number ending with:E	[A6BF] (Multi-function type) Product number ending with:F
			CPU1:Ver1.13 CPU2:Ver1.13	CPU1:Ver1.13 CPU2:Ver1.13
Control mode	Position control(pp)		○	○
	Position control(csp)		○	○
	Position control(ip)		×	×
	Position control(hm)		○	○
	Velocity control(pv)		○	○
	Velocity control(csv)		○	○
	Torque control(tq)		○	○
	Torque control(cst)		○	○
	Torque control(cstca)		×	×
	Full-closed control		×	○
Full-closed control (Rotary scale)		×	○	
Function	Two-degree-of-freedom control(Position)		○	○
	Two-degree-of-freedom control(Velocity)		○	○
	Two-degree-of-freedom control(Torque) *1)		○	○
	Two-degree-of-freedom control(Full-closed)		×	○
	Safety function		×	○
	Vibration control		○	○
	Model type damping filter		○	○
	Feed forward function		○	○
	Load change suppression control		○	○
	Third gain switching function		○	○
	Friction torque compensation		○	○
	Hybrid vibration suppression function		×	○
	Quadrant projection suppressionfunction		○	○
	Torque limit switching function		○	○
	Motor movable range setting function		○	○
	Torque saturation protection function		○	○
	Single-turn absolute function		○	○
	Infinitely rotatable absolute function		○	○
	External scale position information monitor function under semi-closed control		×	○
	Slow stop function		○	○
	Deterioration diagnosis warning function		○	○
	Retracting operation function		○	○
	Position comparison output function		○	○
FoE(File Access over EtherCAT)		×	×	
Jerk		×	×	
Complete Access of SDO message		×	×	

• Some functions cannot be used in [A6BE].

• Where applicable, these items are indicated with “Cannot be used in [A6BE]” in the descriptions contained in this reference for your confirmation.

\*1) Not supported in two-degree-of-freedom control (synchronous type).

## &lt;About Absolute Encoders&gt;

Absolute encoders come in two types: a type that retains multi-turn data with a battery for absolute data (hereafter called the battery-powered absolute encoder), and a type that does not require a battery to retain multi-turn data (hereafter called the “battery-less absolute encoder”).

Functions common to both types of absolute encoders are shown unless specified otherwise.

## &lt;Software version&gt;

This technical reference applies to the servo drivers compatible with software of the following version:

\* Check the software versions 1 and 2 by 3744h (Reference to section 5-2 of EtherCAT communication specification) or setup support software PANATERM.

\* Check the software version 3 by 100Ah(Reference to section 5-2 of EtherCAT communication specification).

Software version	Contents of function change	Available PANATERM																		
CPU1(Version1) Ver1.01 CPU2(Version2) Ver1.01 Manufacture Software (Version3) Ver1.00	First edition	6.0.1.4 or later																		
CPU1(Version1) Ver1.02 CPU2(Version2) Ver1.02 Manufacture Software (Version3) Ver1.00	Function extended edition 1 <table border="1"> <thead> <tr> <th>Additional capability</th> <th>Reference</th> </tr> </thead> <tbody> <tr> <td>1) Serial number range expansion</td> <td>EtherCAT communication specification 5-2,6-9-7,9</td> </tr> <tr> <td>2) Safety function</td> <td>This document 1-1,3-2,7-1,7-2,8</td> </tr> <tr> <td>3) Full-closed control</td> <td>This document 3-2,3-4,4-2-2,4-2-5,4-5,4-7-2,5-2-4, 5-2-7,5-2-13,5-2-18,7-1,7-2,7-3,9-1 EtherCAT communication specification 2-4,6-9-4,6-9-7, 8-2,9</td> </tr> <tr> <td>4) Hybrid vibration damping function</td> <td>This document 5-2-13 EtherCAT communication specification 9</td> </tr> <tr> <td>5) External scale position information monitor function under semi-closed control</td> <td>This document 3-2,4-2,4-8,7-2 EtherCAT communication specification 6-9-7</td> </tr> <tr> <td>6) Retracting operation function</td> <td>This document 2-1,2-4-1,4-2,4-3,4-4,6-9,7-1,7-2,9-1 EtherCAT communication specification 6-2-1,6-9-2, 6-9-3,6-9-7,9</td> </tr> <tr> <td>7) Support for Err27.4 (Command error protection) clear</td> <td>This document 7-1,7-2 EtherCAT communication specification 6-6-5,8-1</td> </tr> <tr> <td>8) Servo information monitor object function expansion</td> <td>EtherCAT communication specification 6-9-4,6-9-7,9</td> </tr> </tbody> </table> (To be continued)	Additional capability	Reference	1) Serial number range expansion	EtherCAT communication specification 5-2,6-9-7,9	2) Safety function	This document 1-1,3-2,7-1,7-2,8	3) Full-closed control	This document 3-2,3-4,4-2-2,4-2-5,4-5,4-7-2,5-2-4, 5-2-7,5-2-13,5-2-18,7-1,7-2,7-3,9-1 EtherCAT communication specification 2-4,6-9-4,6-9-7, 8-2,9	4) Hybrid vibration damping function	This document 5-2-13 EtherCAT communication specification 9	5) External scale position information monitor function under semi-closed control	This document 3-2,4-2,4-8,7-2 EtherCAT communication specification 6-9-7	6) Retracting operation function	This document 2-1,2-4-1,4-2,4-3,4-4,6-9,7-1,7-2,9-1 EtherCAT communication specification 6-2-1,6-9-2, 6-9-3,6-9-7,9	7) Support for Err27.4 (Command error protection) clear	This document 7-1,7-2 EtherCAT communication specification 6-6-5,8-1	8) Servo information monitor object function expansion	EtherCAT communication specification 6-9-4,6-9-7,9	6.0.1.8 or later
Additional capability	Reference																			
1) Serial number range expansion	EtherCAT communication specification 5-2,6-9-7,9																			
2) Safety function	This document 1-1,3-2,7-1,7-2,8																			
3) Full-closed control	This document 3-2,3-4,4-2-2,4-2-5,4-5,4-7-2,5-2-4, 5-2-7,5-2-13,5-2-18,7-1,7-2,7-3,9-1 EtherCAT communication specification 2-4,6-9-4,6-9-7, 8-2,9																			
4) Hybrid vibration damping function	This document 5-2-13 EtherCAT communication specification 9																			
5) External scale position information monitor function under semi-closed control	This document 3-2,4-2,4-8,7-2 EtherCAT communication specification 6-9-7																			
6) Retracting operation function	This document 2-1,2-4-1,4-2,4-3,4-4,6-9,7-1,7-2,9-1 EtherCAT communication specification 6-2-1,6-9-2, 6-9-3,6-9-7,9																			
7) Support for Err27.4 (Command error protection) clear	This document 7-1,7-2 EtherCAT communication specification 6-6-5,8-1																			
8) Servo information monitor object function expansion	EtherCAT communication specification 6-9-4,6-9-7,9																			

Software version	Contents of function change	Available PANATERM	
CPU1(Version1) Ver1.02 CPU2(Version2) Ver1.02 Manufacture Software (Version3) Ver1.00	<b>Function extended edition 1</b>	6.0.1.8 or later	
	<b>Additional capability</b>		<b>Reference</b>
	9) Err 91.1 (Command error protection) for the out-of-range target position setting in the continuous rotating absolute encoder mode		This document 6-7,7-2 EtherCAT communication specification 6-9-4
	10) Err27.7 (Position information initialization error protection) at the time of return to origin cancelation	This document 7-1,7-2 EtherCAT communication specification 8-1	
CPU1(Version1) Ver1.03 CPU2(Version2) Ver1.03 Manufacture Software (Version3) Ver1.00	<b>Function extended edition 2</b>	6.0.1.8 or later	
	<b>Additional capability</b>		<b>Reference</b>
	1) Servo information monitor object function expansion • 4D29h(Over load factor)		EtherCAT communication specification 6-6-1,6-7-1,6-8-1,6-9-7,9
CPU1(Version1) Ver1.05 CPU2(Version2) Ver1.05 Manufacture Software (Version3) Ver1.00	<b>Function extended edition 3</b>	6.0.1.13 or later	
	<b>Additional capability</b>		<b>Reference</b>
	1) Full-closed control (Rotary scale)		This document 4-5-1,4-5-4,9-1 EtherCAT communication specification 1-2,6-9-4,9
	2) Torque offset filter		This document 5-2-1,5-2-2,5-2-3,5-2-4, 5-2-16,5-2-17,5-2-18,6-3-6-2,9-1 EtherCAT communication specification 6-6-1,6-7-1,6-8-1,9
	3) Torque control function in velocity control loop		This document 5-2-1,5-2-2,5-2-3,5-2-4, 5-2-16,5-2-17,5-2-18 EtherCAT communication specification 6-6-1,6-7-1,6-8-1,6-9-3, 6-9-7,9
	4) Velocity integral value clear function		EtherCAT communication specification 6-9-3
	5) Backlash compensation function		This document 1-1,1-2,1-3,1-4,1-5,9-1 EtherCAT communication specification 7-2,9
(To be continued)			

Software version	Contents of function change	Available PANATERM		
CPU1(Version1) Ver1.05 CPU2(Version2) Ver1.05 Manufacture Software (Version3) Ver1.00	<b>Function extended edition 3</b>	6.0.1.13 or later		
			<table border="1"> <thead> <tr> <th data-bbox="480 309 852 336">Additional capability</th> <th data-bbox="852 309 1302 336">Reference</th> </tr> </thead> </table>	Additional capability
	Additional capability		Reference	
	<table border="1"> <tbody> <tr> <td data-bbox="480 344 852 468">6) hm operation specification extension</td> <td data-bbox="852 344 1302 468">This document 9-1 EtherCAT communication specification 6-6-5</td> </tr> </tbody> </table>		6) hm operation specification extension	This document 9-1 EtherCAT communication specification 6-6-5
	6) hm operation specification extension		This document 9-1 EtherCAT communication specification 6-6-5	
	<table border="1"> <tbody> <tr> <td data-bbox="480 477 852 600">7) Extension of Pr5.09 (Main power supply off detection period) setup range</td> <td data-bbox="852 477 1302 600">This document 6-3-3,9-1 EtherCAT communication specification 6-9-2,9</td> </tr> </tbody> </table>		7) Extension of Pr5.09 (Main power supply off detection period) setup range	This document 6-3-3,9-1 EtherCAT communication specification 6-9-2,9
	7) Extension of Pr5.09 (Main power supply off detection period) setup range		This document 6-3-3,9-1 EtherCAT communication specification 6-9-2,9	
	<table border="1"> <tbody> <tr> <td data-bbox="480 609 852 732">8) Torque control under two-degrees-of-freedom control</td> <td data-bbox="852 609 1302 732">This document 5-1-3,5-2-3,7-2 EtherCAT communication specification 1-2,6-5-4</td> </tr> </tbody> </table>		8) Torque control under two-degrees-of-freedom control	This document 5-1-3,5-2-3,7-2 EtherCAT communication specification 1-2,6-5-4
	8) Torque control under two-degrees-of-freedom control		This document 5-1-3,5-2-3,7-2 EtherCAT communication specification 1-2,6-5-4	
	<table border="1"> <tbody> <tr> <td data-bbox="480 741 852 864">9) Extension of Pr6.35 (Hybrid vibration suppression filter) setup range</td> <td data-bbox="852 741 1302 864">This document 5-2-13,9-1 EtherCAT communication specification 9</td> </tr> </tbody> </table>		9) Extension of Pr6.35 (Hybrid vibration suppression filter) setup range	This document 5-2-13,9-1 EtherCAT communication specification 9
	9) Extension of Pr6.35 (Hybrid vibration suppression filter) setup range		This document 5-2-13,9-1 EtherCAT communication specification 9	
	<table border="1"> <tbody> <tr> <td data-bbox="480 873 852 996">10) High response current control Extension of setting range in Pr6.11 (current response setup)</td> <td data-bbox="852 873 1302 996">This document 5-2-20,9-1 EtherCAT communication specification 9</td> </tr> </tbody> </table>		10) High response current control Extension of setting range in Pr6.11 (current response setup)	This document 5-2-20,9-1 EtherCAT communication specification 9
	10) High response current control Extension of setting range in Pr6.11 (current response setup)		This document 5-2-20,9-1 EtherCAT communication specification 9	
	<table border="1"> <tbody> <tr> <td data-bbox="480 1005 852 1173">11) Response to EtherCAT object extension · Torque limit function extension · Velocity limit function extension during torque control</td> <td data-bbox="852 1005 1302 1173">This document 6-1,9-1 EtherCAT communication specification 6-4,6-6,6-7,6-8,9</td> </tr> </tbody> </table>		11) Response to EtherCAT object extension · Torque limit function extension · Velocity limit function extension during torque control	This document 6-1,9-1 EtherCAT communication specification 6-4,6-6,6-7,6-8,9
11) Response to EtherCAT object extension · Torque limit function extension · Velocity limit function extension during torque control	This document 6-1,9-1 EtherCAT communication specification 6-4,6-6,6-7,6-8,9			
<table border="1"> <tbody> <tr> <td data-bbox="480 1182 852 1328">12) Retracting operation specification extension Corresponds to the retracting operation when power supply is shut down.</td> <td data-bbox="852 1182 1302 1328">This document 6-9,9-1</td> </tr> </tbody> </table>	12) Retracting operation specification extension Corresponds to the retracting operation when power supply is shut down.	This document 6-9,9-1		
12) Retracting operation specification extension Corresponds to the retracting operation when power supply is shut down.	This document 6-9,9-1			
<table border="1"> <tbody> <tr> <td data-bbox="480 1337 852 1460">13) Absolute data specification extension</td> <td data-bbox="852 1337 1302 1460">This document 9-1 EtherCAT communication specification 6-9-4</td> </tr> </tbody> </table>	13) Absolute data specification extension	This document 9-1 EtherCAT communication specification 6-9-4		
13) Absolute data specification extension	This document 9-1 EtherCAT communication specification 6-9-4			
<table border="1"> <tbody> <tr> <td data-bbox="480 1469 852 1648">14) Compatible with the battery-less absolute encoder</td> <td data-bbox="852 1469 1302 1648">This document 1, 1-1, 2-3-2, 4-7-1, 4-7-1-3, 4-7-1-4, 6-6, 6-7, 7-2, 7-3 EtherCAT communication specification 6-9-4</td> </tr> </tbody> </table>	14) Compatible with the battery-less absolute encoder	This document 1, 1-1, 2-3-2, 4-7-1, 4-7-1-3, 4-7-1-4, 6-6, 6-7, 7-2, 7-3 EtherCAT communication specification 6-9-4		
14) Compatible with the battery-less absolute encoder	This document 1, 1-1, 2-3-2, 4-7-1, 4-7-1-3, 4-7-1-4, 6-6, 6-7, 7-2, 7-3 EtherCAT communication specification 6-9-4			

Software version	Contents of function change	Available PANATERM
CPU1(Version1) Ver1.06 CPU2(Version2) Ver1.06 Manufacture Software (Version3) Ver1.00	<b>Function extended edition 4</b>	
	<b>Additional capability</b>	<b>Reference</b>
	1) hm operation specification extension Homing in the absolute mode is supported	This document 7-2, 9-1 EtherCAT communication specification 1-1, 6-6-5, 6-9-4, 9
	2) Torque monitor value accuracy improvement	This document 9-1 EtherCAT communication specification 9
CPU1(Version1) Ver1.07 CPU2(Version2) Ver1.07 Manufacture Software (Version3) Ver1.00	<b>Function extended edition 5</b>	
	<b>Additional capability</b>	<b>Reference</b>
	1) Torque control can be switched when 2 degrees of freedom control mode (synchronization type) is selected	This document 1,5-2-19,1-7,7-2 EtherCAT communication specification 1
	2) EtherCAT communication cycle 8ms, 10ms extension	This document 1 EtherCAT communication specification 1,1-2,2-4,5-5,5-5-1,5-5-3,8-2
CPU1(Version1) Ver1.08 CPU2(Version2) Ver1.08 Manufacture Software (Version3) Ver1.00	<b>Function extended edition 6</b>	
	<b>Additional capability</b>	<b>Reference</b>
	1) Specification extension of over-travel inhibition input	This document 6-3-1,7-1,7-2,7-3,9-1 EtherCAT communication specification 3-6-1,6-9-2,8-1,8-3,9

Software version	Contents of function change	Available PANATERM
CPU1(Version1) Ver1.09 CPU2(Version2) Ver1.09 Manufacture Software (Version3) Ver1.00	<b>Function extended edition 7</b>	
	<b>Additional capability</b>	<b>Reference</b>
	1) Velocity limit priority function during torque control	This document 4-4-1,9-1 EtherCAT communication specification 6-8-3
	2) Specification extension of Touch Probe function	This document 9-1 EtherCAT communication specification 6-9-1,9
	3) Target position echo function	This document No change EtherCAT communication specification 6-6-1,9
CPU1(Version1) Ver1.10 CPU2(Version2) Ver1.10 Manufacture Software (Version3) Ver1.00	<b>Function extended edition 8</b>	
	<b>Additional capability</b>	<b>Reference</b>
	1) Expansion of V frame supported	This document 1,1-1,2-4-2,3-1,3-2-1,3-2-2,3-4,4-6,6-3-3, 6-5,6-10,7-1,7-2,8,9-1-1,9-1-5,9-1-6, 9-1-8 EtherCAT communication specification 3-8,3-8-1
	2) Specification extension of backlash compensation function	This document 6-10,9-1 EtherCAT communication specification 9
	3) External scale Z-phase latch function during semi-closed control	This document 1-7,7-1,7-2 EtherCAT communication specification 6-9-1,8-1
CPU1(Version1) Ver1.12 CPU2(Version2) Ver1.12 Manufacture Software (Version3) Ver1.00	<b>Function extended edition 9</b>	
	<b>Additional capability</b>	<b>Reference</b>
	1) Improved EtherCAT communication compatibility	This document 9-1 EtherCAT communication specification No change
CPU1(Version1) Ver1.13 CPU2(Version2) Ver1.13 Manufacture Software (Version3) Ver1.00	<b>Function extended edition 10</b>	
	<b>Additional capability</b>	<b>Reference</b>
	1) Specification extension of Statusword	This document 9-1-8 EtherCAT communication specification 6-6-3
	2) Extension of hm operation specification	This document No change EtherCAT communication specification 6-6-5,9-4

<Software Notice>

This product contains Open Source Software (OSS) and is used under the following license terms.  
Your company may be obliged to use OSS, so please take appropriate measures.

Copyright (c) 2011, Texas Instruments Incorporated  
All rights reserved.

Redistribution and use in source and binary forms, with or without modification, are permitted provided that the following conditions are met:

- \* Redistributions of source code must retain the above copyright notice, this list of conditions and the following disclaimer.
- \* Redistributions in binary form must reproduce the above copyright notice, this list of conditions and the following disclaimer in the documentation and/or other materials provided with the distribution.
- \* Neither the name of Texas Instruments Incorporated nor the names of its contributors may be used to endorse or promote products derived from this software without specific prior written permission.

THIS SOFTWARE IS PROVIDED BY THE COPYRIGHT HOLDERS AND CONTRIBUTORS "AS IS" AND ANY EXPRESS OR IMPLIED WARRANTIES, INCLUDING, BUT NOT LIMITED TO, THE IMPLIED WARRANTIES OF MERCHANTABILITY AND FITNESS FOR A PARTICULAR PURPOSE ARE DISCLAIMED. IN NO EVENT SHALL THE COPYRIGHT OWNER OR CONTRIBUTORS BE LIABLE FOR ANY DIRECT, INDIRECT, INCIDENTAL, SPECIAL, EXEMPLARY, OR CONSEQUENTIAL DAMAGES (INCLUDING, BUT NOT LIMITED TO, PROCUREMENT OF SUBSTITUTE GOODS OR SERVICES; LOSS OF USE, DATA, OR PROFITS; OR BUSINESS INTERRUPTION) HOWEVER CAUSED AND ON ANY THEORY OF LIABILITY, WHETHER IN CONTRACT, STRICT LIABILITY, OR TORT (INCLUDING NEGLIGENCE OR OTHERWISE) ARISING IN ANY WAY OUT OF THE USE OF THIS SOFTWARE, EVEN IF ADVISED OF THE POSSIBILITY OF SUCH DAMAGE.



## &lt; Related data &gt;

SX-DSV03190 : Standard specifications(A6B Series,other than V frame)

SX-DSV03510 : Standard specifications(A6B Series,V frame)

(The specification about hardware, Safety Precautions,Warranty etc. is indicated.

Please be sure to read carefully, after understanding the contents, refer to this specification.)

SX-DSV03242 : Technical Reference (EtherCAT communication specification)

## &lt;IMPORTANT&gt;

- (1) All rights reserved. No part of this publication may be reproduced or transmitted in any form without prior permission.
- (2) Motion Control Business Unit, Panasonic Industry Co., Ltd. reserves the right to make modifications and improvements to its products and/or documentation, including specifications and software, without prior notice.
- (3) For MINAS-A6B series, the shipment setting value was changed from the previous series (MINAS-A5B series, etc.) by enabling "2 degrees of freedom control mode", etc.  
Note that the parameters need to be adjusted again if replacing with MINAS-A6B series from the previous series.  
See the Standard specifications for the shipment setting value of the MINAS-A6B series.
- (4) See Section 1-2 "Main differences from MINAS-A5B series" in technical document - EtherCAT communication specification (SX-DSV03242) for differences from the MINAS-A5B series.
- (5) MINAS-A6B series may not be fully compatible operation with the previous series(MINAS-A5B series).  
In the case of replacing the previous series to MINAS-A6B series, be sure to evaluate.
- (6) See the Specifications Standard specifications for the product number of servo driver that passed the EtherCAT Conformance Test.

EtherCAT® is registered trademark and patented technology,  
licensed by Beckhoff Automation GmbH, Germany.

**EtherCAT**®  
Conformance tested



## 1-1 Basic Specification

Item		Contents																														
Control method		Other than V frame : IGBT PWM method, sinusoidal drive V frame : MOSFET PWM method, sinusoidal drive																														
Control mode		Semi-closed control <table border="1"> <thead> <tr> <th colspan="3">Modes of operation</th> </tr> </thead> <tbody> <tr> <td rowspan="3">Position control</td> <td>pp</td> <td>Profile position mode</td> </tr> <tr> <td>csp</td> <td>Cyclic synchronous position mode</td> </tr> <tr> <td>hm</td> <td>Homing mode</td> </tr> <tr> <td rowspan="2">Velocity control</td> <td>pv</td> <td>Profile velocity mode</td> </tr> <tr> <td>csv</td> <td>Cyclic synchronous velocity mode</td> </tr> <tr> <td rowspan="2">Torque control</td> <td>tq</td> <td>Torque profile mode</td> </tr> <tr> <td>cst</td> <td>Cyclic synchronous torque mode</td> </tr> </tbody> </table> Full-closed control <table border="1"> <thead> <tr> <th colspan="3">Modes of operation</th> </tr> </thead> <tbody> <tr> <td rowspan="3">Position control</td> <td>pp</td> <td>Profile position mode</td> </tr> <tr> <td>csp</td> <td>Cyclic synchronous position mode</td> </tr> <tr> <td>hm</td> <td>Homing mode</td> </tr> </tbody> </table>	Modes of operation			Position control	pp	Profile position mode	csp	Cyclic synchronous position mode	hm	Homing mode	Velocity control	pv	Profile velocity mode	csv	Cyclic synchronous velocity mode	Torque control	tq	Torque profile mode	cst	Cyclic synchronous torque mode	Modes of operation			Position control	pp	Profile position mode	csp	Cyclic synchronous position mode	hm	Homing mode
Modes of operation																																
Position control	pp	Profile position mode																														
	csp	Cyclic synchronous position mode																														
	hm	Homing mode																														
Velocity control	pv	Profile velocity mode																														
	csv	Cyclic synchronous velocity mode																														
Torque control	tq	Torque profile mode																														
	cst	Cyclic synchronous torque mode																														
Modes of operation																																
Position control	pp	Profile position mode																														
	csp	Cyclic synchronous position mode																														
	hm	Homing mode																														
Encoder feedback		23-bit (resolution: 8,388,608) 7-serial Battery-powered absolute encoder 23-bit (resolution: 8,388,608) 5-serial Battery-less absolute encoder *3																														
External scale feedback *1		A/B Phase, origin signal differential input Manufacturers supporting serial communication scale: *1 <ul style="list-style-type: none"> <li>• Mitutoyo Corporation</li> <li>• Heidenhain K.K.</li> <li>• Renishaw K.K.</li> <li>• Magnescale Co., Ltd.</li> <li>• Nidec Sankyo Corporation</li> <li>• Fagor Automation S.Coop</li> </ul>																														
Control signal	Input	Each 8 input can be assigned by the parameter.																														
	Output	Other than V frame : Each 3 output can be assigned by the parameter. V frame : Assignment possible at 2 points (function assignment by parameter), alarm signal output 1 point.																														
Analogue signal	Output	2 outputs for analog monitors 1 and 2*4																														
Pulse signal	Output	Line driver output for encoder pulses (A/B phase signal) or external scale pulses.																														
Communi- cation	EtherCAT	Communication for transmission of a real-time operation command, the parameter setting, or the status monitoring.																														
	USB	USB interface to connect to computers (setup support software PANATERM) for parameter setting or status monitoring. USB cable connection is possible																														
Safety terminal		Terminal to support safety function. *2																														
Front panel		1. 7-segment LED (double digits) *4 2. Network status LED (LINK, COM) 3. Rotary switch for node address setting *4 4. Analog monitor output (Analog monitors 1 and 2) *4 5. ALM LED and SRVON LED *5																														
Regeneration		Frame size A,B,G,H: Without built-in regenerative resistor (use external resistor) Frame size C-F: Built-in regenerative resistor (External regenerative resistor is also available) V frame: No built-in regenerative resistor (external addition not possible)																														
Dynamic brake		For information on the built-in type, refer to the Standard specifications.																														

- \*1: Please contact us for a corresponding part number.
- \*2: This is a function available only in [A6BF]. It is not available in [A6BE].
- \*3: Supported in a software version of function expansion edition 3 or later
- \*4: Cannot be used with [V frame].
- \*5: Can be used only with [V frame].

## 1-2 Function (Position control)

Item		Contents
Control input		Positive direction drive inhibit, negative direction drive inhibit, latch signal, near home position, etc.
Control output		Positioning completion etc.
Position command input	Input mode	Command type by EtherCAT command
	Smoothing Filter	Either a primary delay filter or a FIR type filter can be selected against command input.
Damping control		Available (Up to 3 frequency settings, out of 4 settings in total, can be used simultaneously.)
Model type damping filter		Available (2 filters available) [Requirement] 2 degrees of freedom control is enabled.
Feed forward function		Available (speed/torque)
Load variation suppression function		Available [Requirement] Servo-on. No hindrance for the motor's normal run.
Gain 3 switching function		Available [Requirement] Servo-on. No hindrance for the motor's normal run.
Friction torque compensation		Available [Requirement] Servo-on. No hindrance for the motor's normal run.
Hybrid vibration suppression function		Not available
Quadrant projection suppression function		Available [Requirement] Servo-on. No hindrance for the motor's normal run.
Two-degree-of-freedom control mode		Available (standard/sync type) [Requirement] Servo-on. No hindrance for the motor's normal run.
Torque limit switching function		Available [Requirement] Servo-on. No hindrance for the motor's normal run.
Motor operatable setup function		Available [Requirement] Servo-on. No hindrance for the motor's normal run.
Torque saturation protection function		Available
Single-turn absolute function		Available [Requirement] The absolute encoder is connected.
Continuous rotating absolute encoder function		Available [Requirement] No hindrance for the motor's normal run. The 23-bit absolute encoder is connected. Encoder resolution ( $2^{23}$ )/electronic gear ratio/reduction ratio is an integer less than or equal to $(2^{31}-1)$ .
External scale position information monitor		Available *1
Backlash compensation function		Available [Requirement] Servo-on. No hindrance for the motor's normal run.

\*1: It cannot be used in [A6BE].

## 1-3 Function (Velocity control)

Item		Contents
Control input		Positive direction drive inhibit, negative direction drive inhibit, latch signal, etc.
Control output		At speed etc.
Velocity command input	Input mode	Command type by EtherCAT command
Soft start/slowdown function		0 – 10 s / 1000 r/min Acceleration and deceleration can be set separately. S-curve acceleration/deceleration is also available.
Damping control		Not available
Model type damping filter		Not available
Feed forward function		Available (torque)
Load variation suppression function		Available [Requirement] Servo-on. No hindrance for the motor's normal run.
Gain 3 switching function		Not available
Friction torque compensation		Available [Requirement] Servo-on. No hindrance for the motor's normal run.
Hybrid vibration suppression function		Not available
Quadrant projection suppression function		Not available
Two-degree-of-freedom control mode		Available (standard) [Requirement] Servo-on. No hindrance for the motor's normal run.
Torque limit switching function		Available [Requirement] Servo-on. No hindrance for the motor's normal run.
Motor operatable setup function		Not available
Torque saturation protection function		Available
Single-turn absolute function		Available [Requirement] The absolute encoder is connected.
Continuous rotating absolute encoder function		Available [Requirement] No hindrance for the motor's normal run. The 23-bit absolute encoder is connected. Encoder resolution ( $2^{23}$ )/electronic gear ratio/reduction ratio is an integer less than or equal to ( $2^{31}-1$ ).
External scale position information monitor		Available *1
Backlash compensation function		Not available

\*1: It cannot be used in [A6BE].

## 1-4 Function (Torque control)

Item		Contents
Control input		Positive direction drive inhibit, negative direction drive inhibit, latch signal, etc.
Control output		At speed etc.
Torque command input	Input mode	Command type by EtherCAT command
Speed limit function		Speed limit value can be set by parameter. (Switched by EtherCAT command.)
Damping control		Not available
Model type damping filter		Not available
Feed forward function		Not available
Load variation suppression function		Not available
Gain 3 switching function		Not available
Friction torque compensation		Not available
Hybrid vibration suppression function		Not available
Quadrant projection suppression function		Not available
Two-degree-of-freedom control mode		Setting possible
Torque limit switching function		Not available
Motor operatable setup function		Not available
Torque saturation protection function		Not available
Single-turn absolute function		Available [Requirement] The absolute encoder is connected.
Continuous rotating absolute encoder function		Available [Requirement] No hindrance for the motor's normal run. The 23-bit absolute encoder is connected. Encoder resolution ( $2^{23}$ )/electronic gear ratio/reduction ratio is an integer less than or equal to ( $2^{31}-1$ ).
External scale position information monitor		Available *1
Backlash compensation function		Not available

\*1: It cannot be used in [A6BE].

## 1-5 Function (Full-closed control)

Item		Contents
Control input		Positive direction drive inhibit, negative direction drive inhibit, latch signal, near home position, etc.
Control output		Positioning completion etc.
Position command input	Input mode	Command type by EtherCAT command
	Smoothing Filter	Either a primary delay filter or a FIR type filter can be selected against command input.
External scale division/multiplication set to range		1/40 to 125200 times Although the ratio of encoder pulse (numerator) and external scale pulse (denominator) can be set anywhere between the range of 1 and $2^{23}$ for the numerator and 1 to $2^{23}$ for the denominator, please use within the range indicated above.
Damping control		Available (Up to 2 frequency settings, out of 4 settings in total, can be used simultaneously.)
Model type damping filter		Not available
Feed forward function		Available (speed/torque)
Full-closed to related *1 *2	Load variation suppression function	Available [Requirement] Servo-on. No hindrance for the motor's normal run.
	Gain 3 switching function	Available [Requirement] Servo-on. No hindrance for the motor's normal run.
	Friction torque compensation	Available [Requirement] Servo-on. No hindrance for the motor's normal run.
	Hybrid vibration suppression function	Available [Requirement] Servo-on. No hindrance for the motor's normal run.
	Quadrant projection suppression function	Available [Requirement] Servo-on. No hindrance for the motor's normal run.
	Two-degree-of-freedom control mode	Available (standard type) [Requirement] Servo-on. No hindrance for the motor's normal run.
	Torque limit switching function	Available [Requirement] Servo-on. No hindrance for the motor's normal run.
	Motor operatable setup function	Available [Requirement] Servo-on. No hindrance for the motor's normal run.
	Torque saturation protection function	Available
	Single-turn absolute function	Not available
	Continuous rotating absolute encoder function	Not available
	External scale position information monitor	Available
	Backlash compensation function	Available [Requirement] Servo-on. No hindrance for the motor's normal run.

\*1: It cannot be used in [A6BE].

\*2: The same applies to "Full-closed control (Rotary scale)".

## 1-6 Function (Common)

	Item	Contents
Common	Electronic gear ratio	Applicable scaling ratio: 1/1000–8000
	Auto-tuning	Identifies the load inertia real-time and automatically sets up the gain that meets the stiffness setting when the motor is running with upper and internal operation commands.
	Notch filter	Available (5 filters available)
	Gain switching function	Available
	2-step torque filter	Available [Requirement] Servo-on. No hindrance for the motor's normal operation.
	Position comparison output function	Available [Requirement] EtherCAT communication is established. No hindrance for the motor's normal run. In the case of incremental encoder, home position return must be completed. Other than Continuous rotating absolute mode (Pr0.15=4).
	Protective function	Overvoltage, undervoltage, overspeed, overload, overheat, overcurrent, encoder failure, positional overdeviaition, EEPROM failure, etc.
	Alarm data trace back	Tracing back of alarm data is available
	Deterioration diagnosis function	Available
	Retracting operation function	Available



## 1-7 Main differences from the MINAS-A5B series

There are mainly the following differences in specifications when comparing the MINAS-A6Bseries with the MINAS-A5B series.Please inquire about specification differences other than the below.

<SX-DSV03215 : Technical document(Basic function specifications)>

Chapter	Function	Contents	A5B specification	A6BE(Standard type) Specification	A6BF(Multi-function type) specification
			Ver3.04	CPU1 : Ver1.13,CPU2 : Ver1.13	CPU1 : Ver1.13,CPU2 : Ver1.13
2-1 2-4-1	Input signal	Retracting operation input (RET)	Not supported	Supported	
3-2	7-segment LED	Station Alias display 3700h(Display on LED)=4 (Station alias setting value) display setting	The setting value of RSW of the front panel is displayed regardless of 3741h (Station Alias selection).	The value to be displayed varies depending on the setting value of 3741h (Station Alias selection)  3741h = 0: Value of RSW of the front panel 3741h = 1: Value of Low byte of SII area(0004h)	
3-4	Monitor signal output function	Analog monitor Unit of command position deviation	Encoder unit (No reflection of 607Eh (Polarity))	Command unit (607Eh (Polarity) is reflected.)	
4-2 4-3 4-4 4-5	Torque offset filter (Pr7.113)	A primary delay filter for 60B2h (Torque offset)	Not supported	Supported	
4-2-4	Positioning complete output (INP/INP2) function	Position setup unit select 3520h(Position setup unit select)	Not supported  3520h = 1 fixed (encoder unit)	Supported  3520h =0 : command unit 3520h =1 : encoder unit(external scale)	
4-2-5	Pulse regeneration function	Function for transmitting the movement amount to the host controller with AB pulse	Not supported	Supported	
4-4-1	Speed limit function	Addition of a velocity limit priority function during torque control	Not supported	Supported	
4-5	Full-closed control	Support for the full-closed system with external scale	Not supported	Not supported	Supported
4-5-4	Full-closed control (Rotary scale)	Support for the full-closed system with external rotary scale	Not supported	Not supported	Supported
4-8	External scale position information monitor function under semi-closed control	Function that monitors external scale position information via EtherCAT communication even under semi-closed control	Not supported	Not supported	Supported
5-2-10	Load variation suppression function	Function for suppressing fluctuation of motor speed caused by disturbance torque and load fluctuation and improving stability	Not supported	Supported	
5-2-13	Hybrid vibration damping function	Function that suppresses the vibration resulting from the amount of torsion of the motor and the load in the full-closed control mode	Not supported	Not supported	Supported
5-2-15	Quadrant projection suppression function	Control configuration that suppresses quadrant projection occurring during arc interpolation of 2 or more axes	Not supported	Supported	
5-2-16 5-2-17 5-2-18	Two-degree-of-freedom control mode	2 degrees of freedom control shipment setting condition Shipment value of 3647h (Function expansion setup 2)  Control mode in Two-degree-of-freedom control	Two-degree-of-freedom control Disabled (Shipment value 0)  Position control mode	Two-degree-of-freedom control(standard type) Enabled (Shipment value 1)  • Two-degree-of-freedom control(standard type) Position control mode, Velocity control mode, Torque control mod  • Two-degree-of-freedom control(synchronization type) Position control mod	• Two-degree-of-freedom control(standard type) Position control mod Velocity control mode, Torque control mod Full-closed control mod  • Two-degree-of-freedom control(synchronization type) Position control mod
5-2-20	High response current control	A function to improve responsiveness of the current control unit	Not supported	Supported	
6-3-1	Sequence upon inputting of over-travel inhibition (POT, NOT)	Specification extension of over-travel inhibition input (Extension of conditions for releasing over-travel inhibition)	Not supported	Supported	
6-3-6-2	Fall prevention function in the event of Servo-ON	Internal value state selection of 60B2h (Torque offset) switching bit in servo-off (fall prevention function in the event of Servo-ON)	Switching with 3724h bit10	Switching with 3724h bit7	
6-5	Position comparison output function	Function that enables a general-purpose output or encoder output terminal to output a pulse signal when the actual position passes the position set for the parameter	Not supported	Supported	
6-7	Continuous rotating absolute encoder function	Function that enables setting of the upper limit value for the absolute encoder multi-turn data arbitrarily	Not supported	Supported	

(To be continued)

## &lt;SX-DSV03215 : Technical document(Basic function specifications)&gt;

Chapter	Function	Contents	A5B specification	A6BE(Standard type) specification	A6BF(Multi-function type) specification
			Ver3.04	CPU1 : Ver1.13,CPU2 : Ver1.13	CPU1 : Ver1.13,CPU2 : Ver1.13
6-8	Deterioration diagnosis warning function	Function that checks the changes in motor and connected equipment characteristics to output deterioration diagnosis warning.	Not supported	Supported	
6-9	Retracting operation function	Function that executes retracting operation at the velocity and amount of movement set up as parameters when the condition is established.	Not supported	Supported	
6-10	Backlash compensation function	Function that backlash compensation and the specification extension of backlash compensation	Not supported	Supported	
7-1	List of Protective Function	Err16.1 (Torque saturation error protection) Occurrence factor	Torque saturated is continued for the value set for Pr7.16 "Torque saturation error protection times"	Torque saturated is continued for the time set for Pr7.16 "Torque saturation error protection times" or Pr6.57 "Torque saturation error protection time"	
7-2	Details of Protective function	Err27.4 (Position command error protection) clear attribute	Not clearable	Clearable	
		Err27.7 (Position information initialization error protection)	Not supported	Supported	
		Err60.0 (Motor setting error protection)	Not supported	Supported	
		Err87.1 (Retracting operation completion (I/O))	Not supported	Supported	
		Err87.3 (Retracting operation completion)	Not supported	Supported	
		Err88.1 (Control mode setting error protection) Occurrence factor	The mode other than position control is set for 6060h (Modes of operation) while in 2 degrees freedom control mode	<ul style="list-style-type: none"> <li>• 6060h (Modes of operation) 3(pv) or 9(csv) is set up under 2 degrees of freedom control mode (synchronization type).</li> </ul>	<ul style="list-style-type: none"> <li>• 6060h (Modes of operation) 3 (pv) or 9 (csv) is set up under 2 degrees of freedom control mode (synchronization type).</li> <li>• 2 degrees of freedom control mode (synchronization type) was set when under full-closed control</li> </ul>
		Err88.2 (ESM requirements during operation error protection) Occurrence factor	When the ESM state received a transition command to other ESM states with the PDS state at "Operation enabled" or "Quick stop active".	<ul style="list-style-type: none"> <li>• When the ESM state received a transition command to other ESM states with the PDS state at "Operation enabled" or "Quick stop active".</li> <li>• When 3799 bit0=1 is set, the command for transitioning from the current ESM to other ESM state is received during servo-on (while warning D2 is occurring) on PANATERM.</li> </ul>	
		Err91.1 (Command error protection) Occurrence factor	Control mode was switched at intervals shorter than 2ms.	<ul style="list-style-type: none"> <li>• A position where it cannot shift to infinite turn absolute mode (outside the range for Position range limit (607Bh)) was set as the target position.</li> </ul>	<ul style="list-style-type: none"> <li>• Communication cycle was set to 0.250 ms or 0.125 ms under semi-closed control while the external scale position information monitor function is valid.</li> <li>• Communication cycle was set to 0.250 ms or 0.125 ms under full-closed control and DC synchronous mode or SM2 synchronous mode.</li> <li>• A position where it cannot shift to infinite turn absolute mode (outside the range for Position range limit (607Bh)) was set as the target position.</li> </ul>
Err91.3 (Command error protection 2) Occurrence factor	Not supported	Supported			
Err93.5 (Parameter setting error protection 4) Occurrence factor	Not supported	Supported			
7-3	Warning function	Warning latch state setup function 3627h(Warning latch state setup)	Not supported 3627h is fixed at 3. (Both extended warning and general warning are latched.)	Supported	
		Over-load warning detection level and Over-load warning release level	A5B: Not supported A5BL: Supported Over-load warning detection level(3673h) Over-load warning release level (3674h)	Supported Over-load warning detection level(3695h) Over-load warning release level (3696h)	
		D3h (Over-travel inhibition warning)	Not supported	Supported	
7-4	Excess positional deviation protection setting	<ul style="list-style-type: none"> <li>• Position deviation excess setup 3014h(Position deviation excess setup)</li> <li>• Positioning complete range unit 3431h(Positioning complete (In-position)range) 3442h(Positioning Complete (In-position)range 2)</li> </ul>	Encoder unit	It is possible to change to command unit or encoder unit(external scale unit) by 3520h(Position setup unit select).  3520h = 0 : command unit 3520h = 1 : encoder unit (external scale)	
8-1	safe torque off (STO) function	The state when STO function is activated	Alarm state Occurrence of Err30.0 (safety input protection)	Not supported	Alarm does not occur. Front panel display is "St"

<SX-DSV03242 : Technical document (EtherCAT Communication Specifications)>

Refer to Technical document EtherCAT communication specifications (SX-DSV03242), Section 1-2.

## 2. Interface Specification

## 2-1 I/O connector input signal

Title of signal	Symbol	Connector pin No. *2)	Contents	Related control mode *1)				EtherCAT communications	
				Position	Velocity	Torque	Full-close	command	monitor *3)
Input signal source	I-COM	6	<ul style="list-style-type: none"> <li>Connect to the positive or negative terminal of the external DC source (12–24 V).</li> </ul>	/	/	/	/	/	/
Forced alarm input	E-STOP	*	<ul style="list-style-type: none"> <li>Generates Err 87.0 “Forced alarm input error”.</li> </ul>	○	○	○	○	-	-
Positive direction over-travel inhibition input	POT	7 (SI2)	<ul style="list-style-type: none"> <li>Positive direction over-travel inhibit input.</li> <li>The operation with this input turned ON is set up in Pr 5.04 “Setup of over-travel inhibit input”.</li> <li>When using Positive direction over-travel inhibit input, connect the signal so that the input is turned ON when the moving portion of the machine travels in positive direction exceeding a limit.</li> <li>If used as a home position reference trigger in a home position return, this input signal can only be assigned to SI6, respectively.</li> <li>The signal width should be 1 ms or longer then at the time of closing, and should be 2 ms or longer then at the time of opening.</li> <li>Please keep in mind that it cannot guarantee this value.</li> </ul>	○	○	○	○	-	○
Negative direction over-travel inhibition input	NOT	8 (SI3)	<ul style="list-style-type: none"> <li>Negative direction over-travel inhibit input.</li> <li>The operation with this input turned ON is set up in Pr 5.04 “Setup of over-travel inhibit input”.</li> <li>When using Negative direction over-travel inhibit input, connect the signal so that the input is turned ON when the moving portion of the machine travels in negative direction exceeding a limit.</li> <li>If used as a home position reference trigger in a home position return, this input signal can only be assigned to SI7, respectively.</li> <li>The signal width should be 1 ms or longer then at the time of closing, and should be 2 ms or longer then at the time of opening.</li> <li>Please keep in mind that it cannot guarantee this value.</li> </ul>	○	○	○	○	-	○
Near home input	HOME	9 (SI4)	<ul style="list-style-type: none"> <li>When using the near home sensor during the return to home position operation, input the sensor signal.</li> <li>If used as a home position reference trigger in a home position return, the input can only be assigned to SI5, respectively.</li> <li>The signal width should be 1 ms or longer then at the time of closing, and should be 2 ms or longer then at the time of opening.</li> <li>Please keep in mind that it cannot guarantee this value.</li> </ul>	○	○	○	○	-	○
Retracting operation input	RET	*	<ul style="list-style-type: none"> <li>Activates a retracting operation if conditions are satisfied according to the setting for Pr6.85 “Retracting operation condition setting”</li> </ul>	○	○	○	○	-	○

Title of signal	Symbol	Connector pin No. *2)	Contents	Related control mode *1)				EtherCAT communications	
				Position	Velocity	Torque	Full-close	command	monitor *3)
External latch input 1	EXT1	10 (SI5)	<ul style="list-style-type: none"> <li>• These signals are used for touch-probe function or homing function.</li> <li>• This input can only be set to a-contact.</li> <li>• The signal width should be 1 ms or longer then at the time of closing, and should be 2 ms or longer then at the time of opening. It cannot guarantee this value.</li> <li>• EXT1 can only be assigned to S15.</li> <li>• EXT2 can only be assigned to S16.</li> </ul>	○				-	○
External latch input 2	EXT2	11 (SI6)		○				-	○
General purpose monitor input 1	SI-MON 1	*	<ul style="list-style-type: none"> <li>• Used as the general purpose monitor input.</li> <li>• This input does not affect the operation, and can be used for monitoring through 4F21h(Logical input signal), 4F23h(Logical input signal(expansion portion)), 60FDh(Digital inputs).</li> </ul>	△				-	○
General purpose monitor input 2	SI-MON 2	*		△				-	○
General purpose monitor input 3	SI-MON 3	12 (SI7)		△				-	○
General purpose monitor input 4	SI-MON 4	13 (SI8)		△				-	○
General purpose monitor input 5	SI-MON 5	5 (SI1)		△				-	○
External alarm clear input	A-CLR	*	<ul style="list-style-type: none"> <li>• Dis arm inputs the alarm.</li> <li>• There are alarms that cannot be disarmed by this input.</li> </ul>	○				-	○
Dynamic brake (DB) switching input	DB-SEL	*	<ul style="list-style-type: none"> <li>• Switches the dynamic brake (DB) ON/OFF after stop (when the main power is off).</li> <li>• Switching is only possible when main power supply off is detected.</li> <li>• For details, refer to 6-3-3.</li> </ul>	○				-	○

\*1) The triangle in the table under [Control mode] indicates that the turning ON/OFF of the input signal does not affect system operation.

\*2) Except for I-COM, input signal pin assignment can be changed. The pins in “Connector pin No.” column in the table denote factory default settings. The signal with a pin that is marked with “\*” is not assigned by default. For more information, refer to “2-4-1 Input signal allocation”.

\*3) It is possible to monitor the condition of the signals where “○” is attached to the EtherCAT communication monitor on the table with 4F21h(Logical input signal), 4F23h(Logical input signal(expansion portion)), 60FDh (Digital inputs).

2-2 I/O connector output signal									
Title of signal	Symbol *2)	Connector pin No.	Contents	Related control mode *1)				EtherCAT communi- cations	
				Position	Velocity	Torque	Full- close	command	monitor *3)
Servo-Alarm output	ALM+	3 (S03+)	<ul style="list-style-type: none"> <li>This signal shows that the driver is in alarm status.</li> <li>Output transistor turns ON when the driver is at normal status, and turns OFF at alarm status.</li> </ul>					—	○
	ALM- (Alarm)	4 (S03-)							
Servo-Ready output	S-RDY (Servo_Ready)	*	<ul style="list-style-type: none"> <li>This signal shows that the driver is ready to be activated.</li> <li>The servo becomes ready when all the following conditions are satisfied, and the output transistor is turned on.               <ol style="list-style-type: none"> <li>Control/Main power is established.</li> <li>Alarm does not occur.</li> <li>EtherCAT communication is established.</li> </ol> </li> </ul>					—	○
External brake release signal	BRK-OFF+	1 (S01+)	<ul style="list-style-type: none"> <li>Feeds out the timing signal which activates the electromagnetic brake of the motor.</li> <li>Transistor is turned ON when electromagnetic brake is released.</li> <li>This output needs to be assigned to every control mode.</li> </ul>					—	○
	BRK-OFF-	2 (S01-)							
set brake output	set brake	*	<ul style="list-style-type: none"> <li>Outputs the signal configured at 60FEh:Digital output /bit 0.</li> <li>Transistor will be turned off at “1”. (Brake will be activated.)</li> <li>See the notes *4) state the output transistor.</li> </ul>					○	—
Positioning complete	INP	*	<ul style="list-style-type: none"> <li>Outputs the positioning complete signal/positioning complete signal.</li> <li>Turns ON the output transistor when positioning is completed.</li> <li>For details, refer to 4-2-4.</li> </ul>	○	—	—	○	—	○
Speed arrival output	AT-SPEED	*	<ul style="list-style-type: none"> <li>Outputs the speed arrival signal.</li> <li>Turns on the output transistor when a velocity is reached.</li> <li>For details, refer to 4-3-1.</li> </ul>	—	○	○	—	—	○
Torque in-limit signal output	TLC	*	<ul style="list-style-type: none"> <li>Outputs the torque in-limit signal.</li> <li>Turns on the output transistor when torque is limited.</li> <li>For details, refer to 6-4.</li> </ul>					○	—
Zero-speed detection output signal	ZSP	*	<ul style="list-style-type: none"> <li>Outputs the zero-speed detection signal.</li> <li>Turns on the output transistor when zero velocity is detected.</li> </ul>					○	—
Speed matching output	V-COIN	*	<ul style="list-style-type: none"> <li>Outputs the speed matching signal.</li> <li>Turns on the output transistor when velocity matches.</li> <li>For details, refer to 4-3-2.</li> </ul>	—	○	○	—	—	○
Positioning complete 2	INP2	*	<ul style="list-style-type: none"> <li>Outputs the positioning complete signal/positioning complete signal 2.</li> <li>Turns on the output transistor upon positioning completion 2.</li> <li>For details, refer to 4-2-4.</li> </ul>	○	—	—	○	—	○
Warning output 1	WARN1	*	<ul style="list-style-type: none"> <li>Outputs the warning output signal set to Pr 4.40 “Warning output select 1”</li> <li>Turns on the output transistor when a selected alarm occurs.</li> </ul>					○	—

Title of signal	Symbol *2)	Connector pin No.	Contents	Related control mode *1)				EtherCAT communi- cations	
				Position	Velocity	Torque	Full- close	command	monitor *3)
Warning output 2	WARN2	*	<ul style="list-style-type: none"> <li>Outputs the warning output signal set to Pr 4.41 “Warning output select 2”</li> <li>Turns on the output transistor when a selected alarm occurs.</li> </ul>		○			—	○
Positional command ON/OFF output	P-CMD	*	<ul style="list-style-type: none"> <li>Outputs the position command ON/OFF signal.</li> <li>Turns on the output transistor when the positioning command (before filter) is other than 0 (with positioning command).</li> </ul>	○	—	—	○	—	○
Speed in-limit output	V-LIMIT	*	<ul style="list-style-type: none"> <li>Outputs the speed limit signal during torque command.</li> <li>Turns on the output transistor when velocity is limited.</li> </ul>	—	—	○	—	—	○
Alarm attribute output	ALM-ATB	*	<ul style="list-style-type: none"> <li>The signal is output if an alarm which can be cleared, is input.</li> <li>Turns on the output transistor when an alarm occurs.</li> </ul>		○			—	○
Velocity command ON/OFF output	V-CMD	*	<ul style="list-style-type: none"> <li>Turns on output transistor when the velocity command is applied while the velocity is controlled.</li> <li>Turns on the output transistor if the velocity command (before filter) is not less than 30r/min (with velocity command).</li> </ul>	—	○	—	—	—	○
General purpose output 1	EX-OUT1+	25 (S02+)	<ul style="list-style-type: none"> <li>Output signal set by Bit16 of 60FEh(Digital outputs). (ON at 1, OFF at 0)</li> <li>For the state of the output transistor, refer to Note *4.</li> </ul>		○			○	○
	EX-OUT1-	26 (S02-)							
Servo on status output	SRV-ST (Servo_Active)	*	<ul style="list-style-type: none"> <li>Turns on the output transistor during servo on.</li> </ul>		○			—	○
Position comparison output	CMP-OUT	*	<ul style="list-style-type: none"> <li>The output transistor is turned ON or OFF when the actual position passes the position set by the parameter.</li> </ul>		○			—	—
Deterioration diagnosis velocity output	V-DIAG	*	<ul style="list-style-type: none"> <li>Output transistor turned ON when motor speed is within the range of Pr4.35 “Speed coincidence range” of Pr5.75 “Deterioration diagnosis velocity setting”.</li> <li>There is a hysteresis of 10r/min in the coincidence judgment of deterioration diagnosis velocity.</li> </ul>		○			—	○

\*1) For the signal with “-” sign in the “Related control mode” column, the output transistor is always turned off in that control mode.

\*2) Output pin assignment can be changed. The pins in “Connector pin No.” column in the table denote factory default settings. The signal with a pin that is marked with “\*” is not assigned by default. For more information, refer to “2-4-2 Assignment of output signal”.

\*3) It is possible to monitor the condition of the signals where “○” is attached to the EtherCAT communication monitor on the table with 4F22h(Logical output signal) or 60FDh (Digital inputs).

\*4) The state of output transistor changes as follows in each communication state:

Sign	Setting value of Pr7.24	Setting value of 60FEh		State of output transistor			
		01h (Physical outputs)	02h (Bit mask)	Reset	Communication established *5)	Communication intercepted *5)	Communication re-established *5)
set brake	-	0	0	set brake = 1 (brake on)	set brake = 1 (brake on)	set brake = 1 (brake on)	set brake = 1 (brake on)
		1					
		0	1	set brake = 1 (brake on)	set brake = 0	set brake = 1 (brake on)	set brake = 0
		1			set brake = 1 (brake on)		set brake = 1 (brake on)
EX-OUT1	bit0 = 0 (hold)	0	0	EX-OUT1 = 0	EX-OUT1 = 0	EX-OUT1 = 0	EX-OUT1 = 0
		1					
		0	1	EX-OUT1 = 0	EX-OUT1 = 0	EX-OUT1 = 0 (hold)	EX-OUT1 = 0
		1			EX-OUT1 = 1	EX-OUT1 = 1 (hold)	EX-OUT1 = 1
	bit0 = 1 (initialization)	0	0	EX-OUT1 = 0	EX-OUT1 = 0	EX-OUT1 = 0	EX-OUT1 = 0
		1					
		0	1	EX-OUT1 = 0	EX-OUT1 = 0	EX-OUT1 = 0	EX-OUT1 = 0
		1			EX-OUT1 = 1		EX-OUT1 = 1

\*5) “Communication established”, “Communication intercepted”, and “Communication re-established” refer to the following cases.

Communication established	ESM state is PreOP or higher
Communication intercepted	PDO communication is disabled (ESM state transitioned to other states than OP), or SDO communication is disabled (ESM state transitioned to Init)
Communication re-established	60FEh-01h or 60FEh-02h has been written successfully

**Safety precautions:**

When executing set brake signal control using 60FEh (Digital outputs), be sure to use it in PDO and enable the PDO watch dog.  
In SDO, the communication shutoff cannot be judged, the brake may be kept to be released and it is unsafe.  
Please ensure safety on the equipment side.



## 2-3 I/O connector other signal

## 2-3-1 Encoder output signal / Position comparison output signal

Title of signal	Symbol	Connector pin No.	Contents	Control mode				EtherCAT communications	
				Position	Velocity	Torque	Full-close	command	monitor
A-phase output / Position comparison output 1	OA+ / OCMP1+	17	<ul style="list-style-type: none"> <li>Outputs frequency-divided encoder signals or external scale signals differentially (RS422 equivalent).</li> </ul>	○				—	—
	OA- / OCMP1-	18							
B-phase output / Position comparison output 2	OB+ / OCMP2+	20	<ul style="list-style-type: none"> <li>Ground for line driver of output circuit is connected to signal ground (GND) and is not insulated.</li> </ul>						
	OB- / OCMP2-	19							
Position comparison output 3	OCMP3+	21	<ul style="list-style-type: none"> <li>Max. output frequency is 4 Mpps (after quadrupled)</li> <li>When Pr4.47 "Pulse output selection" is set to 1, can be used as position compare output.</li> </ul>						
	OCMP3-	22							
Signal ground	GND	16	<ul style="list-style-type: none"> <li>Signal ground</li> </ul>						

## 2-3-2 Others

Title of signal	Symbol	Connector pin No.	Contents	Control mode				EtherCAT communications	
				Position	Velocity	Torque	Full-close	command	monitor
Frame ground	FG	shell	<ul style="list-style-type: none"> <li>This output is connected to the ground terminal inside of the driver.</li> </ul>						
Absolute encoder battery input	BTP-I	14	<ul style="list-style-type: none"> <li>Connect the battery for absolute data (recommended: ER6V 3.6 V from Toshiba Battery), as follows.</li> <li>Connect the power for multi-turn data storage to the absolute encoder through BTP-O (pin 3) and BTN-O (pin 4) of encoder connector X6.</li> <li>Select either of the following: connect the battery directly to the encoder connection cable; or connect the battery to this terminal.</li> <li>When using the battery-less absolute encoder, do not connect anything to this terminal.*1)</li> </ul>						
	BTN-I	15							
To be used by the manufacturer.	—	23, 24	<ul style="list-style-type: none"> <li>Keep these pins unconnected.</li> </ul>						

\*1) Supported in a software version of function expansion edition 3 or later

## 2-4 I/O signal allocation function

Default I/O signal allocation can be changed.

## 2-4-1 Input signal allocation

Desired input signal can be allocated to any input pin of I/O connector. The logic can be changed.

Some allocation limit is applied to specific signals. Refer to “(2) Reallocation of input signal”.

## (1) Using with the default setting

The table below shows default signal allocation.

Note: Default settings of certain model will differ from those shown below. If the default settings shown in Specifications are different from values shown below, the settings described in Standard specifications are valid default values.

Pin name	Pin No.	Applicable parameter	Default setting ( ): decimal notation	Default setup					
				Position/ Full-closed control		Velocity control		Torque control	
				Signal	Logic *1)	Signal	Logic *1)	Signal	Logic *1)
SI1	5	Pr 4.00	00323232h (3289650)	SI-MON5	a-contact	SI-MON5	a-contact	SI-MON5	a-contact
SI2	7	Pr 4.01	00818181h (8487297)	POT	b-contact	POT	b-contact	POT	b-contact
SI3	8	Pr 4.02	00828282h (8553090)	NOT	b-contact	NOT	b-contact	NOT	b-contact
SI4	9	Pr 4.03	00222222h (2236962)	HOME	a-contact	HOME	a-contact	HOME	a-contact
SI5	10	Pr 4.04	00202020h (2105376)	EXT1	a-contact	EXT1	a-contact	EXT1	a-contact
SI6	11	Pr 4.05	00212121h (2171169)	EXT2	a-contact	EXT2	a-contact	EXT2	a-contact
SI7	12	Pr 4.06	00303030h (3158064)	SI-MON3	a-contact	SI-MON3	a-contact	SI-MON3	a-contact
SI8	13	Pr 4.07	00313131h (3223857)	SI-MON4	a-contact	SI-MON4	a-contact	SI-MON4	a-contact

## \*1) Operation of a-contact and b-contact:

a-contact: The current in the input circuit is shut down and the photocoupler is turned OFF.

— function disabled (OFF state)

The current flows through the input circuit and the photocoupler is turned ON.

— function enabled (ON state)

b-contact: The current in the input circuit is shut down and the photocoupler is turned OFF.

— function enabled (ON state)

The current flows through the input circuit and the photocoupler is turned ON.

— function disabled (OFF state)

For the purpose of this specification, the status of the input signal is defined as ON when the signal activates the specified function and OFF when the signal deactivates the specified function.

And when the photocoupler is turned OFF, time to signal detection becomes long and Variation becomes large.

## (2) Reallocation of input signal

To change the allocation of input signal, change the following parameters.

Class	No.	Attribute *1)	Title	Range	Unit	Function	Latch correction function
4	00	C	SI1 input selection	0– 00FFFFFFh	—	<p>Assign functions to SI1 inputs. These parameters are presented in hexadecimals. Hexadecimal presentation is followed by a specific control mode designation. 0 0 _ _ _ _ * * h: position/full-closed control 0 0 _ _ * * _ _ h: velocity control 0 0 * * _ _ _ _ h: torque control Replace * * with the function number. For the function number see the table below. Logical setup is also a function number.</p> <p>Example: To make this pin as SI-MON1_a-contact for position/full closed control, and as SI-MON2_b-contact for velocity control, and as disabled in torque control mode, set to 0000AF2Eh. Position ... 2Eh Velocity ... AFh Torque ... 00h</p>	—
4	01	C	SI2 input selection	0– 00FFFFFFh	—	<p>Assign functions to SI2 inputs. Setup procedure is the same as described for Pr 4.00.</p>	—
4	02	C	SI3 input selection	0– 00FFFFFFh	—	<p>Assign functions to SI3 inputs. Setup procedure is the same as described for Pr 4.00.</p>	—
4	03	C	SI4 input selection	0– 00FFFFFFh	—	<p>Assign functions to SI4 inputs. Setup procedure is the same as described for Pr 4.00.</p>	—
4	04	C	SI5 input selection	0– 00FFFFFFh	—	<p>Assign functions to SI5 inputs. Setup procedure is the same as described for Pr 4.00. * This pin has a latch correction function.</p>	○
4	05	C	SI6 input selection	0– 00FFFFFFh	—	<p>Assign functions to SI6 inputs. Setup procedure is the same as described for Pr 4.00. * This pin has a latch correction function.</p>	○
4	06	C	SI7 input selection	0– 00FFFFFFh	—	<p>Assign functions to SI7 inputs. Setup procedure is the same as described for Pr 4.00. * This pin has a latch correction function.</p>	○
4	07	C	SI8 input selection	0– 00FFFFFFh	—	<p>Assign functions to SI8 inputs. Setup procedure is the same as described for Pr 4.00.</p>	—

\*1) For parameter attribute. refer to Section 9-1.

Function number table

Title	Symbol	Setup value	
		a-contact	b-contact
Invalid	—	00h	Can not configure
Positive direction over-travel inhibition input	POT	01h	81h
Negative direction over-travel inhibition input	NOT	02h	82h
External alarm clear input	A-CLR	04h	Can not configure
Forced alarm input	E-STOP	14h	94h
Dynamic brake switching input	DB-SEL	16h	Can not configure
External latch input 1	EXT1	20h	A0h
External latch input 2	EXT2	21h	A1h
Near home input	HOME	22h	A2h
Retracting operation input	RET	27h	A7h
General purpose monitor input 1	SI-MON1	2Eh	AEh
General purpose monitor input 2	SI-MON2	2Fh	AFh
General purpose monitor input 3	SI-MON3	30h	B0h
General purpose monitor input 4	SI-MON4	31h	B1h
General purpose monitor input 5	SI-MON5	32h	B2h

■ Precautions for input signal assignment

- Do not setup to a value other than that specified in the table.
- The same signal can't be assigned to multiple pins. Otherwise, duplicated assignment will cause Err 33.0 "Input multiple assignment error 1 protection" or Err 33.1 "Input multiple assignment error 2 protection".
- A signal used in multiple control modes should be assigned to the same pin and the logic should be matched. If not assigned to the same pin, the Err33.0 "Input duplicate assignment error 1 protection" or Err33.1 "Input duplicate assignment error 2 protection" occurs. In case that the logics do not match, Err33.2 "Input function number error 1 protection" or Err33.3 "Input function number error 2 protection" will occur.
- The duplicated assignment of SI-MON1 and EXT1, SI-MON2 and EXT2, SI-MON4, and SI-MON5 and E-STOP is not allowed. Duplicate assignment will cause Err33.0 "Input duplicate assignment error 1 protection" or Err33.1 "Input duplicate assignment error 2 protection".
- A-CLR can only be set at a-connect. If set at b-connect, then Err33.2 "Input function number assignment error 1 protection" or Err33.3 "Input function number assignment error 2 protection" will occur.
- The control mode is switched forcibly inside the driver depending on its operating status irrespective of the command from the host device. This operation has an effect on input signal processing.  
Basically, please allocate same function in one terminal in all modes.

[Conditions that the control mode is switched forcibly inside the driver]

- When frequency characteristic is measured by Setup support software.  
(Position loop characteristics is position control, the speed closed loop characteristic and torque speed (vertical) are speed control, torque speed (normal) is torque control.)
  - Test run of the setup support software (Forcibly controls the position).
  - The states that are written "Forcibly controls the position" in "Deceleration stop sequence" (Section 6-3).
  - "Retracting operation" in operation (Forcibly controls the position)
- Setting is required for all control modes after setting Pr6.36 "Dynamic brake operation input setup" to 1, in case of using dynamic brake switching input (DB-SEL). In case only one or two control modes are set, either Err33.2 "Input function number error 1" or Err33.3 "Input function number error 2" will occur. Please refer to 6-3-3 for details.

## &lt;Precautions for latch correction pins (SI5/SI6/SI7)&gt;

- EXT1 can be allocated only to SI5, EXT2 only to SI6. Wrong allocation will cause Err 33.8 “Latch input allocation error protection”.
- In the following cases, Err33.8 “Latch input allocation error protection” occurs
  - HOME is assigned to SI6 or SI7
  - POT is assigned to SI5 or SI7
  - NOT is assigned to SI5 or SI6
- When using POT/NOT as the home reference trigger in the return to home position operation, set Pr 5.04 to 1 .  
If Pr 5.04 is not 1, Err38.2 “Over-travel inhibit input protection 3” occurs.
- When latch correction pins (SI5/SI6/SI7) are used, set up is required for all the control modes.  
If configuration is made only for 1 or 2 modes, the Err33.8 “Latch input allocation error protection” occurs.

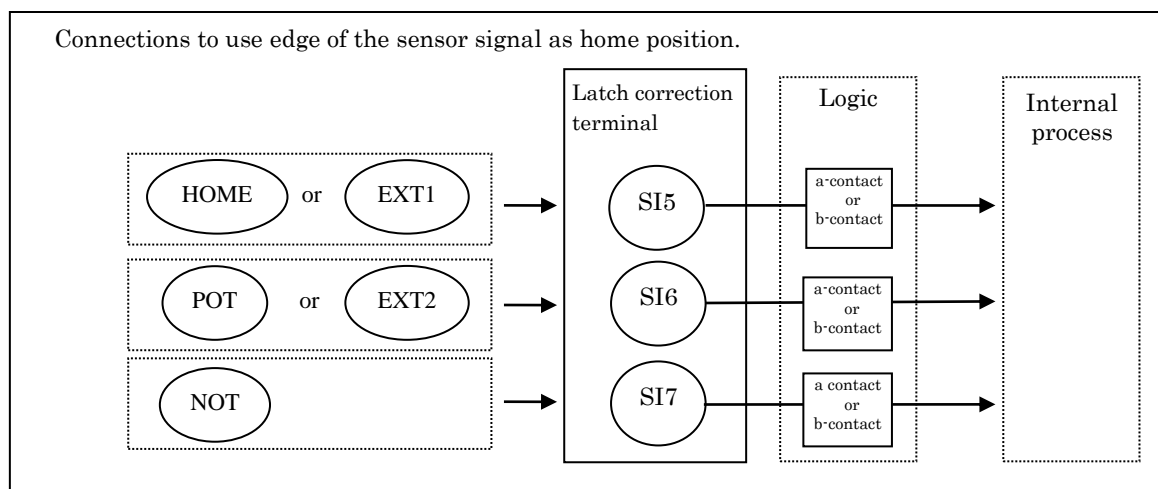

## Safety precautions:

The over-travel inhibit input (POT, NOT) and forced alarm input (E-STOP) should normally be set to b-contact, which stops when wire is broken.

If a-contact is specified, be sure that there is no safety hazard.

## 2-4-2 Assignment of output signal

For the output signals, any functions can be assigned to the output pins of the I/O connector.  
Some assignments may be restricted. Refer to (2) [Reallocation of output signal].

## (1) Using the default setting

The table below shows default signal allocation.

Note: Default settings of certain model will differ from those shown below.

If the default settings shown in Standard specification are different from values shown below,  
the settings described in Standard specification become valid standard default values.

Pin name	Pin No.	Applicable parameter	Default setting ( ): decimal notation	Default Setup		
				Position/ Full-closed control	Velocity control	Torque control
SO1	1 2	Pr 4.10	00030303h (197379)	BRK-OFF	BRK-OFF	BRK-OFF
SO2	25 26	Pr 4.11	00101010h (1052688)	EX-OUT1	EX-OUT1	EX-OUT1
SO3	3 4	Pr 4.12	00010101h (65793)	ALM	ALM	ALM

• For V frame, SO3 is fixed to ALM. Please do not change Pr4.12 from the shipment value setting.

## (2) [Reallocation of output signal].

To change the allocation of output signal, change the following parameters.

Class	No.	Attribute *1)	Title	Range	Unit	Function
4	10	C	SO1 output selection	0– 00FFFFFFh	—	Assign functions to SO1 outputs. These parameters are presented in hexadecimal. Hexadecimal presentation is followed by a specific control mode designation. 0 0 – – – * * h: position/full-closed control 0 0 – – * * – – h: velocity control 0 0 * * – – – h: torque control Replace * * with the function number. For the function number see the table below.
4	11	C	SO2 output selection	0– 00FFFFFFh	—	Assign functions to SO2 outputs. Setup procedure is the same as described for Pr 4.10.
4	12	C	SO3 output selection	0– 00FFFFFFh	—	Assign functions to SO3 outputs. Setup procedure is the same as described for Pr 4.10. ※Please do not change the shipment value setting with V frame.

\*1) For parameter attribute, refer to Section 9-1.

Function number table

Title of signal	Symbol	Setup value
	External output	
Invalid	—	00h
Alarm output	ALM	01h
Servo-Ready output	S-RDY	02h
External brake release signal	BRK-OFF	03h
Positioning complete output	INP	04h
At-velocity output	AT-SPEED	05h
Torque in-limit signal output	TLC	06h
Zero-speed detection output signal	ZSP	07h
Speed matching output	V-COIN	08h
Warning output1	WARN1	09h
Warning output2	WARN2	0Ah
Positional command ON/OFF output	P-CMD	0Bh
Positioning complete 2	INP2	0Ch
Speed in-limit output	V-LIMIT	0Dh
Alarm attribute output	ALM-ATB	0Eh
Velocity command ON/OFF output	V-CMD	0Fh
General purpose output 1	EX-OUT1	10h
set brake output *1)	set brake	11h
Servo on status output	SRV-ST	12h
Position comparison output	CMP-OUT	14h
Deterioration diagnosis velocity output	V-DIAG	15h

\*1) “set brake output“ is reversal from logic of 60FEh(digital output).  
When 60FEh is “1”, the output signal is “OFF” (brake is activate).



### ■ Precautions for output signal assignment

- For output signals, the same function can be assigned to multiple pins. However, the output logic setting must be the same. In addition, when using the same function for multiple control modes, the same output logic must be set. If different output logic was set, the output signal state will become unstable.
- For the output pins specified as disabled, output transistors are always turned off. However, EtherCAT communication response is not affected.
- Use only the values shown in the table above for setting.
- When using external brake release signal (BRK-OFF) or set brake output, the signal should be set in all control modes. If not applied to all control modes, Err 33.4 “Output function number error 1 protection” or Err 33.5 “Output function number error 2 protection” will occur.
- The output transistor is turned off, during a period from when the driver’s control power of a servo driver is turned on to when initialization is completed. And while control power is turned off, during a reset, and while the display on the front face indicates as follows:



Design of system needs to consider the above fact so that any problem does not occur.

- The control mode is switched forcibly inside the driver depending on its operating status irrespective of the command from the host device. This operation has an effect on input signal processing.

Basically, please allocate same function in one terminal in all modes.

[Conditions for the control mode to be switched forcibly inside the driver]

- When frequency characteristic is measured by Setup support software.  
(Position loop characteristics is position control, the speed closed loop characteristic and torque speed (vertical) are speed control, torque speed (normal) is torque control.)
- Test run of the setup support software (Forcibly controls the position).
- The states that are written “Forcibly controls the position” in “Deceleration stop sequence” (Section 6-3).
- “Retracting operation” in operation (Forcibly controls the position)

### 3. Front panel display specification

#### 3-1 Appearance of front panel

Other than V frame

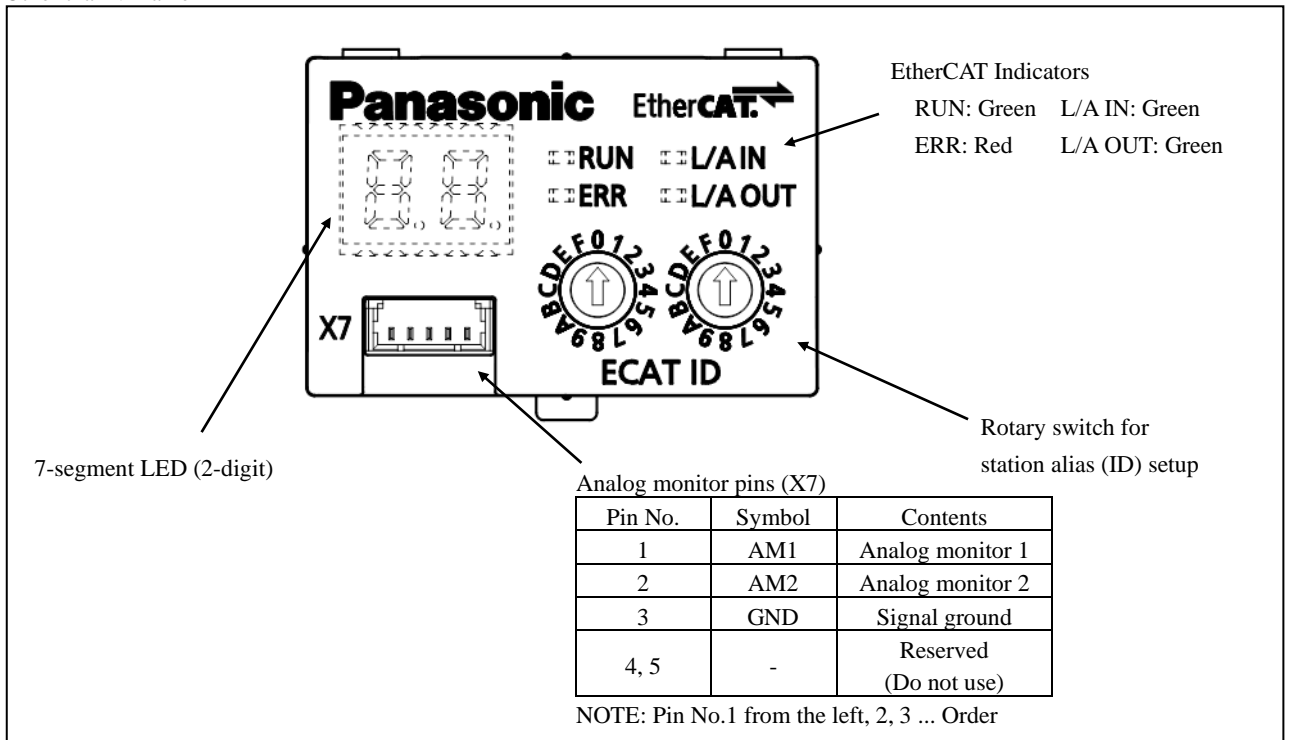

V frame

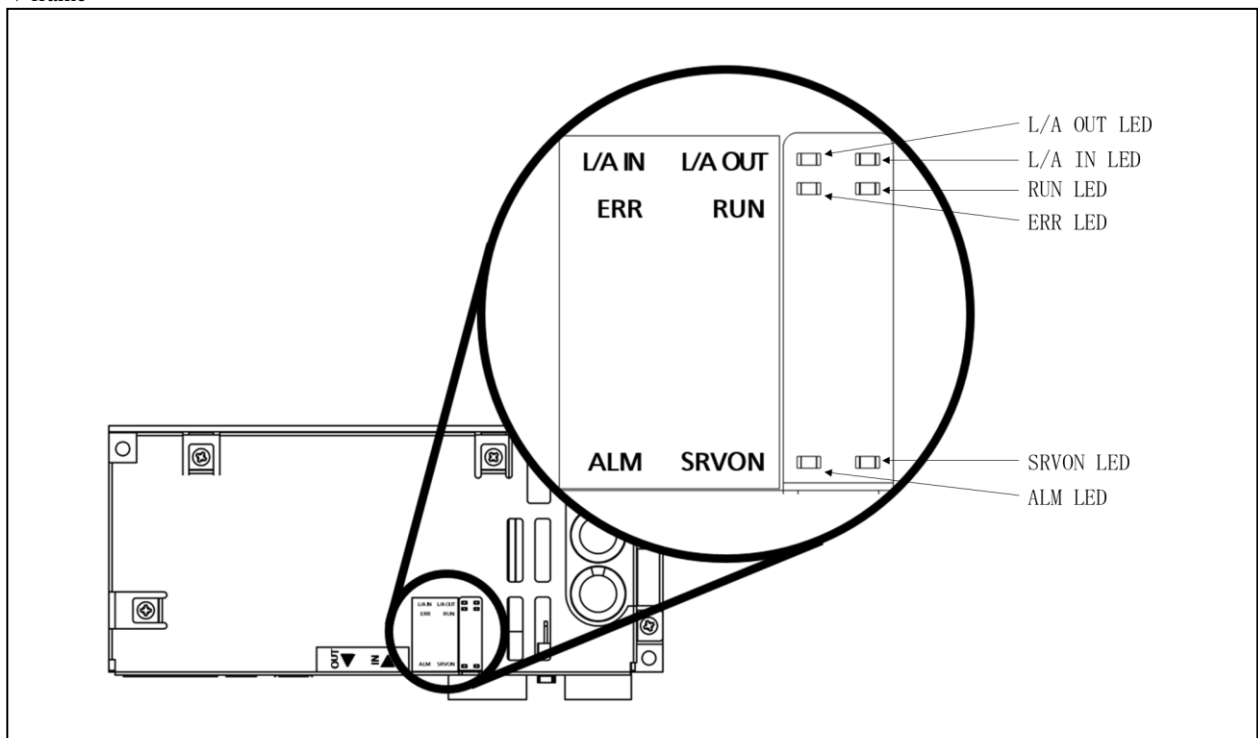

## 3-2 7-Segment LED , ALM and SRVON LED

## 3-2-1 7 Segment LED

Cannot be used with [V frame].

Station alias value set with RSW will be displayed at control power-UP, after that, the setting contents of Pr 7.00 (LED display) will be displayed. Upon occurrence of an alarm, set of alarm codes (main and sub, alternately) is displayed. Upon occurrence of warning, the warning code will be displayed.

## ■ Relevant parameters

Class	No.	At-tribute *1)	Title	Range	Unit	Function
7	00	A	Information on LED	0-32767	—	Selects the information displayed on 7-SEG LED display.
7	01	R	Address display time upon power up	0-1000	100 ms	Sets Station alias(Lower) display (NOTE) time upon turning the control power ON. When the setting value is 0 to 6, it is processed in 600ms. (NOTE) In the case of Pr7.41(Station alias selection)=1, although SII's setting value is used to Station alias, even in this case, display the setting value of the rotary switch.

\*1) For parameter attribute, refer to Section 9-1.

Pr 7.00	Information on display	Remarks
0	Normal display	[--]: servo OFF, [00]: servo ON
1	Mechanical angle	Range: 0 to FFF hex. 0: zero position of 1 revolution data of encoder. Data increments as motor turns CCW. When the displayed value exceeds [FF], the count is reset to [0] and restarted. When the incremental encoder is used, upon turning the control power ON, [nF] (not Fixed) is displayed until zero position of the encoder is detected.
2	Electrical angle	Display range: 0 to FF hex. 0: the position where U phase induced voltage reaches the positive peak. Data increments as motor turns CCW. When the displayed value exceeds [FF], the count is reset to [0] and restarted.
4	Station alias value (Rotary switch setting)	Lower 8bits of station alias value that set by rotary switch at power ON is displayed. Station alias is 0 to F[hex], the display is one-digit. Station alias is upper than 10[hex], the display is two-digit. Values to be read out vary depending on the setting values of Pr7.41 "Station alias selection". Pr7.41=0: Rotary switch of the front panel and the setting value of Pr7.40 However, if both are 0, then the Value of SII area (0004h). Pr7.41=1: Value of SII area (0004h)
5	Encoder Accumulated communication error counts	Display range: 0 to FF hex. Max. accumulated communication error counts: FFFF hex.
6	External scale Accumulated communication error counts	Only the least significant byte is displayed. When the displayed value exceeds [FF], the count is reset to [00] and continue counting. * Accumulated communication error counts will be cleared upon turning the control power OFF.
7	External scale Z phase counter	When the incremental external scale is used in full closed control or in semi-closed control with the external scale position information monitor function enabled, displays the value of Z phase counter read from external scale: 0-F hex. * This displayed value is not affected by the value of Pr 3.26 Reversal of direction of external scale. This function is effective only in the case of the serial incremental external scale and in the external scale of the A/B/Z phase, "nA" (not Available) is indicated. When the external scale position information monitor function under semi-closed control is disabled, "nA" is indicated. * With the first edition of the software version (Ver1.01), under semi-closed control with the external scale position information monitor function enabled, "nA" is indicated.
10	Over load factor	Display range: 0 to FF hex. The ratio [%] to the rated load is displayed. If the Over load factor is 100[%], "64" is displayed. If the Over load factor is larger than 255[%], "nA" (not Available) is displayed.
Other	To be used by the manufacturer but not by the user.	—

The following figure shows the state flow of 7-segment LED.

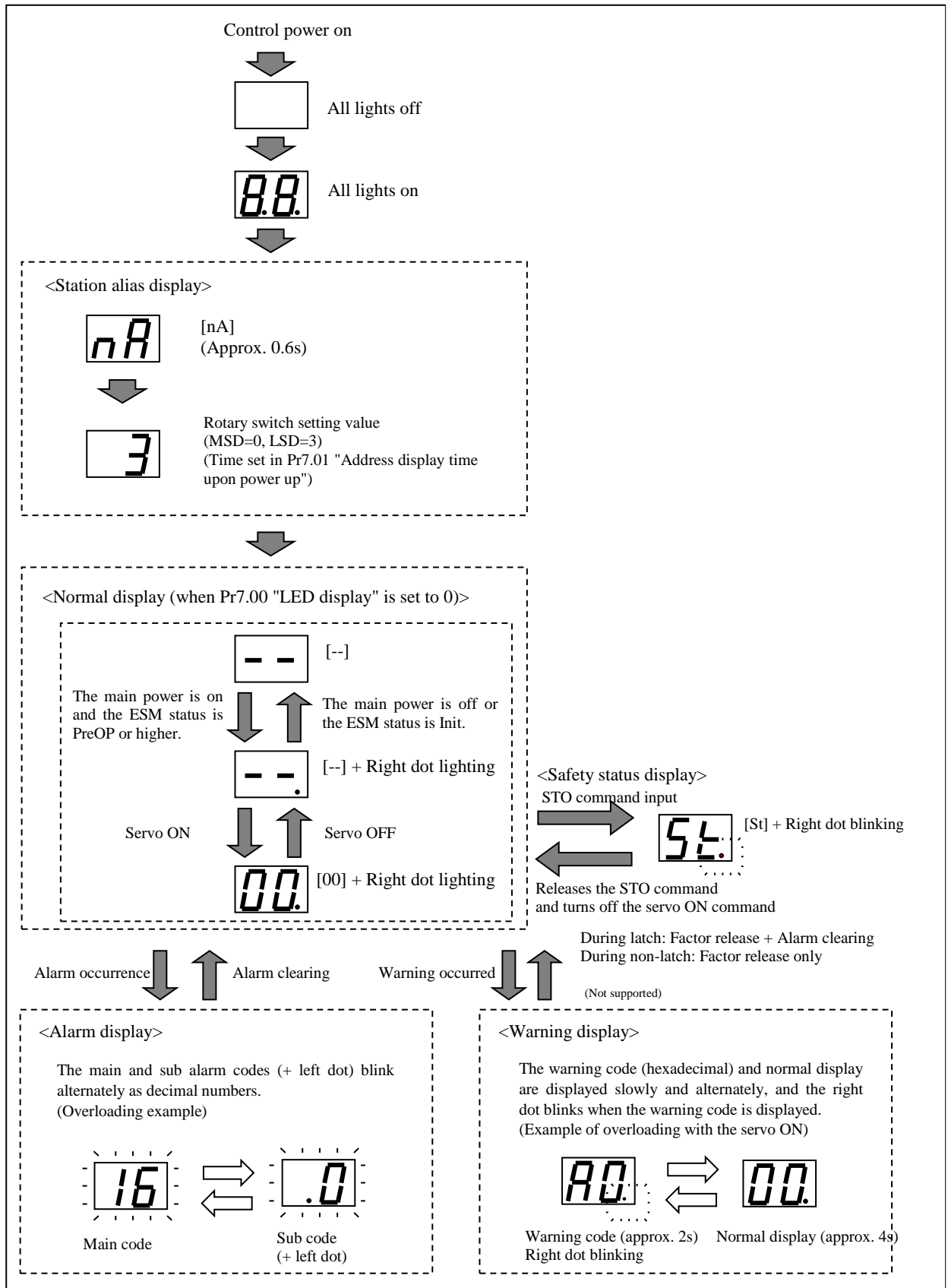

### 3-2-2 ALM LED and SRVON LED

V frame, ALM LED and SRVON LED are equipped for simple status check.

Display	Description	Display color	Status	Description
ALM	Alarm LED	Red	Lit	Alarm occurred
			Not lit	Normal
SRVON	Servo on LED	Green	Lit	Motor servo ON status
			Not lit	Motor servo OFF status

### 3-3 EtherCAT Indicators

MINAS-A6B series has 4 types of EtherCAT indicators (LED).

There are 4 patterns of LED indication in addition to “ON” and “OFF”

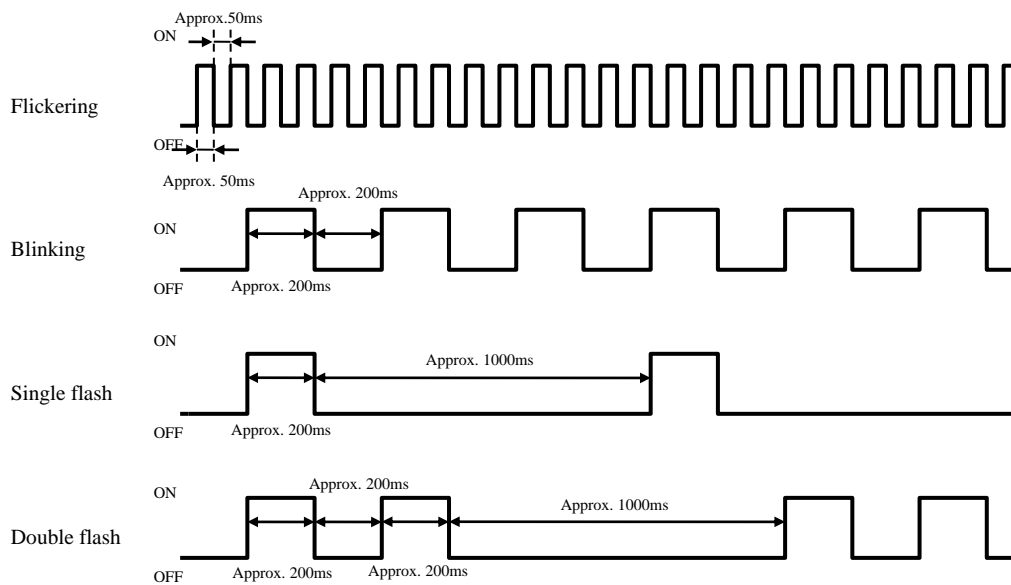

Other than V frame

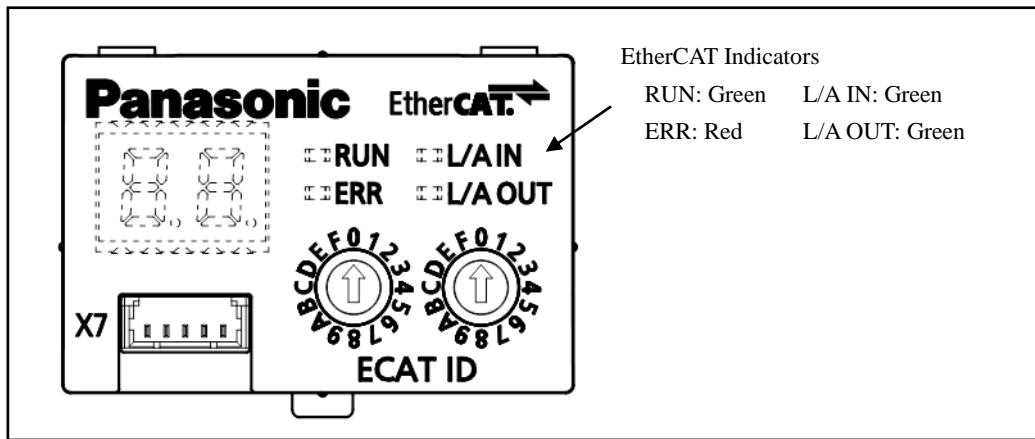

V frame

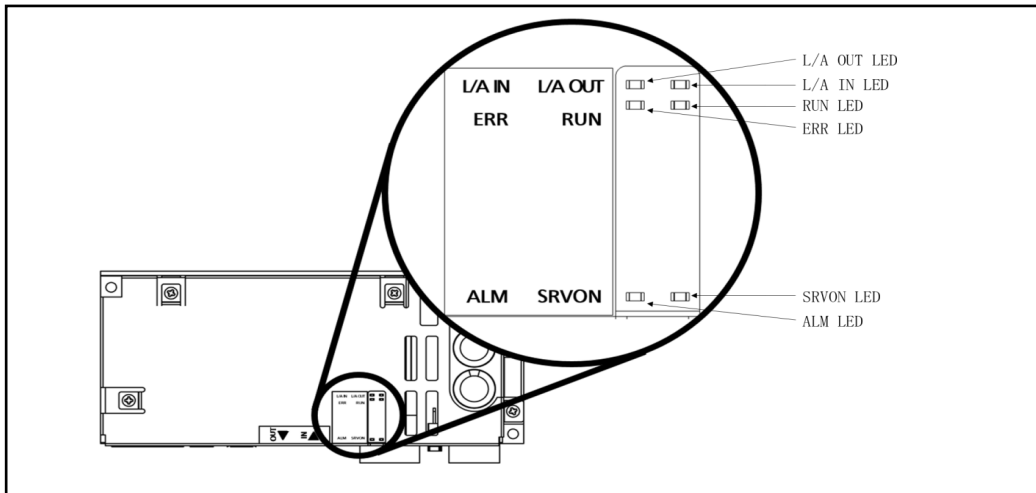

## 1) RUN

RUN indicator will show the status of ESM(EtherCAT State Machine).  
Indication is lighted in green.

LED	Content
OFF	ESM:INIT
Flickering	ESM:Bootstrap
Blinking	ESM:Pre-Operational
Single flash	ESM:Safe-Operational
ON	ESM:Operational

## 2) ERR

ERR Indicator will show the state of the alarm defined by AL status code. \*1)  
Indication is lighted in red.

LED	Content
OFF	With no generating of the alarm defined by AL Status code *1)
Blinking	Communication setting error
Single flash	Synchronize event error
Double flash	Application watch dog time out
Flickering	Initialize error
ON	PDI error *2)

\*1) " The alarm defined by AL status code " is which indicate Err80.0-7 and Err81.0-7, Err85.0-7 in the EtherCAT communication related error.

\*2) MINAS-A6B series is not detected.

## 3) L/A IN

## 4) L/A OUT

L/A IN, L/A OUT indicator will show the LINK status and operation status of  
Each port's physical layer.  
Indication is lighted in green.

LED	Content
OFF	LINK not established
Flickering	LINK established. There are data transmission and reception.
ON	LINK established. There are no data transmission and reception.

If the period until LINK establishment is too long, this phenomenon may be improved by the following measures.

- Changing bit11 (Link establishment mode selection) in Pr7.22 "Communication function extended setup 1"
- Setting the Pr6.18 values of adjacent servo drivers to different values (example: 0.0 s and 0.1 s).

Class	No.	Attribute *1)	Title	Range	Unit	Function
6	18	R	Power-up wait time	0~100	0.1s	Set up the standard initialization time approx. $1.5\text{ s} + \alpha(\text{setting value} \times 0.1\text{ s})$ after power-up. For example, in the case of the preset value 10, it is set to $1.5\text{ s} + (10 \times 0.1\text{ s}) = \text{approx. } 2.5\text{ s}$ . * If the period until LINK establishment is too long, this phenomenon may be improved by setting the Pr6.18 values for adjacent servo drivers to different values (for example, 0.0 s and 0.1 s).
7	22	R	Communication function extended setup 1	-32768~32767	—	bit11 : Link establishment mode selection 0 : mode0, 1 : mode1 If link establishing is late, it might be improved by changing the setting.

\*1) Refer to Section 9-1 for parameter attribute.

## 3-4 Monitor signal output function

Cannot be used with [V frame].

2 types of analog signals can be output for monitoring from the analog monitor connectors (X7) in the front panel. Types of monitor and scaling (output gain setting) can be set by the parameters below.

## ■ Relevant parameters

Class	No.	Attribute *1)	Title	Range	Unit	Function
4	16	A	Type of analog monitor 1	0-30 *2)	—	Select the type of monitor for analog monitor 1. * See the next page.
4	17	A	Analog monitor 1 output gain	0-214748364	[Monitor unit in Pr 4.16] / V	Set up the output gain of analog monitor 1. For Pr 4.16 = 0 Motor velocity, 1 V is output at the motor velocity [r/min] = Pr 4.17 setup value.
4	18	A	Type of analog monitor 2	0-30 *2)	—	Select the type of monitor for analog monitor 2. *See the next page.
4	19	A	Analog monitor 2 output gain	0-214748364	[Monitor unit in Pr 4.18] / V	Set up the output gain of analog monitor 2. For Pr 4.18 = 4 Torque command, 1 V is output at the torque command [%] = Pr 4.19 setup value.
4	21	A	Analog monitor output setup	0-2	—	Select output format of the analog monitor. 0: Signed data output      -10 V to 10 V 1: Absolute value data output    0 V to 10 V 2: Data output with offset      0 V to 10 V (5 V at center)

\*1) Refer to Section 9-1 for parameter attribute.

\*2) In the enhanced version 6 and earlier, the setting range is 0 to 28.

## (1) Pr 4.21 Analog monitor output setup:

Figure below shows output specification when Pr 4.21 is 0, 1 or 2.

Pr 4.21 = 0, signed data output  
(output range -10 to 10 V)

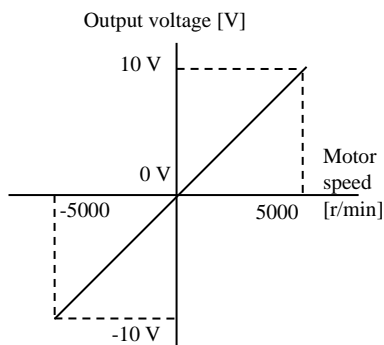

Pr 4.21 = 1, absolute value data output  
(output range 0 to 10 V)

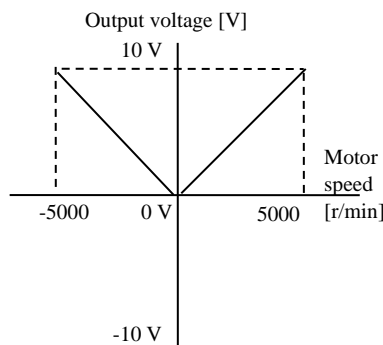

Pr 4.21 = 2, data output with offset  
(output range 0 to 10 V)

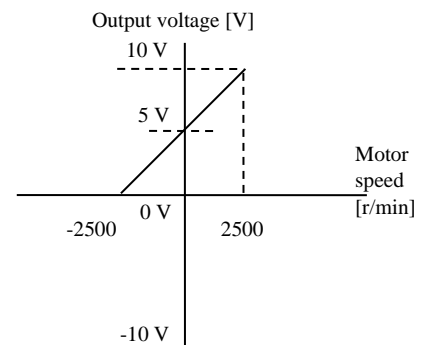

• When monitor type is motor speed, and conversion gain is 500 (1 V = 500 r/min).



(2) The table below shows types of monitor set in Pr 4.16 “Type of analog monitor 1” and Pr 4.18 “Type of analog monitor 2”. Pr 4.17 “Analog monitor 1 output gain” and Pr 4.19 “Analog monitor 2 output gain” respectively set the conversion gain in accordance to the unit suitable for the type. When the gain is set to 0, the gain shown at the right end column of the table is automatically applied.

Pr 4.16/Pr 4.18	Type of monitor	Unit	Output gain for setting Pr 4.17/Pr 4.19 = 0
0	Motor velocity	r/min	500
1	Positional command velocity *2	r/min	500
2	Internal positional command velocity *2	r/min	500
3	Velocity control command	r/min	500
4	Torque command	%	33
5	Command positional deviation *3	pulse (Command unit)	3000
6	Encoder positional deviation *3	pulse (Encoder unit)	3000
7	Full-closed deviation *3	pulse (External scale unit)	3000
8	Hybrid deviation	pulse (Command unit)	3000
9	Voltage across PN	V	80
10	Regenerative load factor	%	33
11	Overload factor	%	33
12	Positive direction torque limit	%	33
13	Negative direction torque limit	%	33
14	Speed limit value	r/min	500
15	Inertia ratio	%	500
16	Reserved	—	—
17	Reserved	—	—
18	Reserved	—	—
19	Encoder temperature	°C	10
20	Driver temperature	°C	10
21	Encoder single-turn data *1	pulse (Encoder unit)	110000
22	Reserved	—	—
23	Travel command status *4	—	—
24	Gain selection status *4	—	—
25	Positioning complete state *6	0: Positioning not completed 1: Positioning completed	—
26	Alarm triggered state *6	0: Alarm not triggered 1: Alarm triggered	—
27	Motor power consumption	W	100
28	Amount of motor power consumption *5	Wh	100
29	For manufacturer's use	—	—
30	For manufacturer's use	—	—

\*1 The direction of monitor data is basically as defined in polarity setting,  
However, the direction of encoder rotational data is defined positive when it turns CCW.

- \*2 For the command pulse input, the speed before the command filter (smoothing, FIR filter) is defined as positional command velocity and speed after filter is defined as internal command velocity.

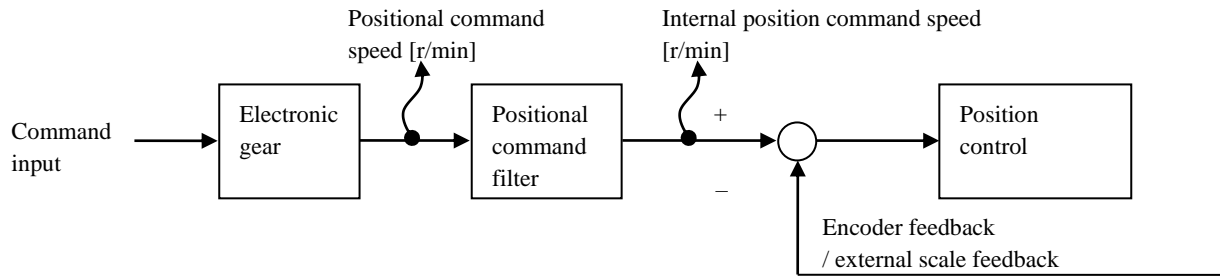

- \*3 The calculation methods (standard) of a position deviation differ by EtherCAT communication and analog monitor, PANATERM. EtherCAT communication serves as a deviation to the instruction input before a position instruction filter. On the analog monitor and PANATERM, switchover is accomplished as follows according to the setting for the command position deviation output switching (bit 14) of Pr7.23 "Communication function Extended setup 2".

Pr7.23 bit14=0: Deviation with respect to command input after positional command filter  
 Pr7.23 bit14=1: Deviation with respect to command input before positional command filter

The figure below shows details.

Position deviation (Command unit) of analog monitor and PANATERM (For Pr7.23 bit14=0)

The position deviation(Command unit) of EtherCAT communication 4F01h(Following error actual value(after filtering))

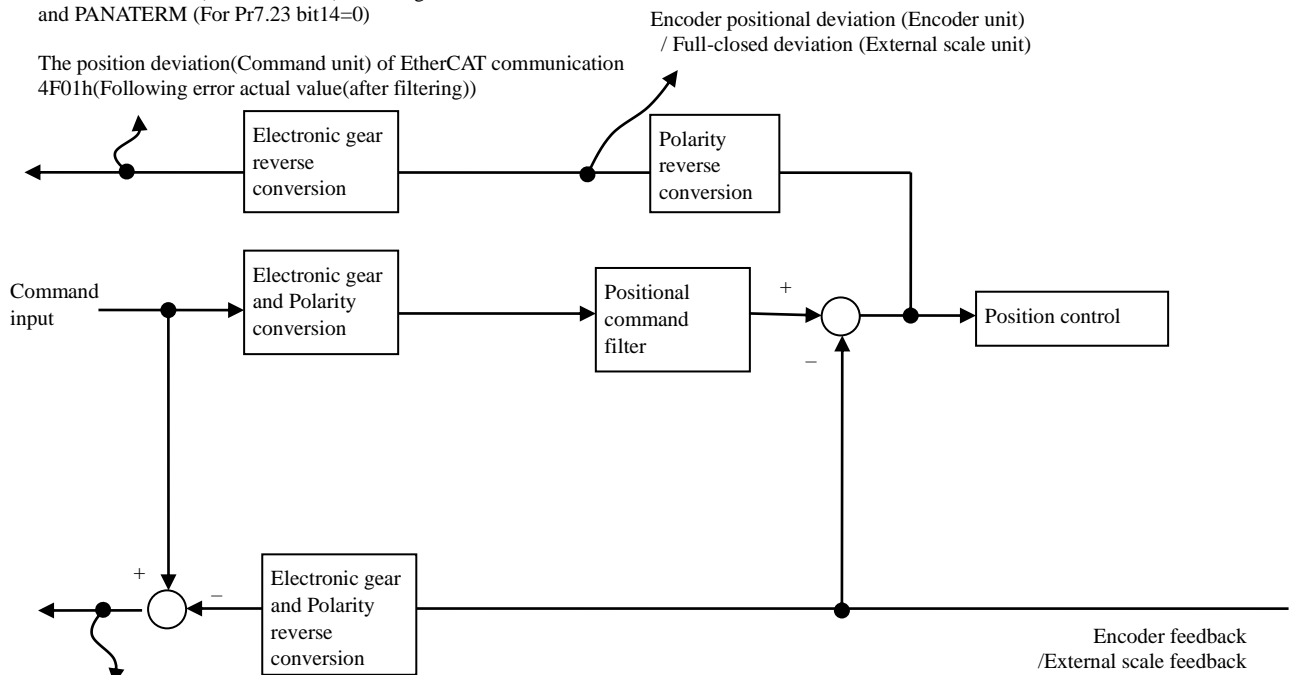

Position deviation(Command unit) of analog monitor and PANATERM (For Pr7.23 bit14=1)

The position deviation(Command unit) of EtherCAT communication 60F4h(Following error actual value)

- \*4 For the monitor types No.23 and 24, digital signals are monitored using an analog monitor.  
So, regardless the value of Pr4.17 “Analog monitor 1 output gain” and Pr4.19 “Analog monitor 2 output gain”,  
the output gain is as follows:

Pr4.16 /Pr4.18	Monitor type		Output voltage	
			0 [V]	+5 [V]
23	Travel command status	Profile Position control(pp)	250us interval Travel command ≠ 0	250us interval Travel command = 0
		Cyclic Position control(csp)	Communication cycle interval Travel command ≠ 0	Communication cycle interval Travel command = 0
		Velocity control	Velocity command ≠ 0	Velocity command = 0
		Torque control	Torque command ≠ 0	Torque command = 0
24	Gain selection status	2nd gain (Including 3rd gain)	1st gain	

※The output of travel command status in position control(pp, csp) is different from those of the MINAS-A5B series.

- \*5 The amount of motor power consumption per 30 minutes is output. The value is updated after the elapse of 30 minutes.  
(Example) In the case of operation for 30 minutes with a motor power consumption of 10W  
 $10[W] \times 0.5[h] = 5[Wh]$

- \*6 Regardless of the setting for Pr4.17 and Pr4.19, the output become 0V at Unit 0 and 5V at Unit 1.

## 3-5 Station alias

Station alias can be set up by the following three methods.

## 1) Reading the value of SII from Configured Station Alias

Reading the value of 0004h(Configured Station Alias) in the SII from 0012h(Configured Station Alias) of ESC register.

## 2) Reading the value of rotary switch from Configured Station Alias

Reading the value made of object 3740h(Station alias setup(high)) and front panel rotary switch from 0012h(Configured Station Alias) of ESC register.

## 3) Reading the value of rotary switch from AL Status Code (Explicit Device ID)

Reading the value made of object 3740h(Station alias setup(high)) and front panel rotary switch from AL Status Code(0134h).

Please refer to 3-8-2 clause "Node addressing (Setting Station alias)" by technical document -EtherCAT communication specification- (SX-DSV03242) for details.

## • Selection of Station alias

Class	No.	Attribute *1)	Parameter	Setting range	Unit	Function	
7	40	R	Station alias setting (upper)	0 - 255	—	Set the upper 8 bits of station alias.	
7	41	R	Station alias selection	0 - 2	—	Defines the station alias setting method	
						Value	Function
						0	Setting by rotary switch on front panel, and by Pr7.40 will be station alias.
						1	Value of SII area (0004h) will be station alias.
2	For manufacturer's use						

## 4. Basic function

### 4-1 Rotational direction setup

Polarity (Rotational direction) can be set up to position command / velocity command / torque command, and each offset.

In the MINAS-A6B series, the rotational direction cannot be set by Pr0.00 (Rotational direction setting), but it can be set by the object 607Eh (Polarity) specified to CoE (CiA402).

Please refer to section 6-9-4 "3) Polarity(607Eh)" of Technical Document "EtherCAT Communication Specifications" (SX-DSV03242) for details of object 607Eh (Polarity).

Setting value	Contents
0	No reverse of sign of objects related to torque, velocity, and position
224	Reverse of sign of objects related to torque, velocity, and position
Other than above	Not supported (Do not set)

In addition, object 607Eh (Polarity) is not what replaced parameter Pr0.00(Rotational direction setting) as it was, it becomes effective when performing the following data transfer between a CoE (CiA402) process division and a motor control process division.

- < Instructions / setting >
  - 607Ah(Target position)
  - 60B0h(Position offset)
  - 60FFh(Target velocity)
  - 60B1h(Velocity offset)
  - 6071h(Target torque)
  - 60B2h(Torque offset)
- <Monitor >
  - 4F04h(Position command internal value(after filtering))
  - 6062h(Position demand value)
  - 6064h(Position actual value)
  - 606Bh(Velocity demand value)
  - 606Ch(Velocity actual value)
  - 6074h(Torque demand)
  - 6077h(Torque actual value)
  - 6078h(Current actual value)
- < External input >
  - 60FDh(Digital input) bit1(positive limit switch(POT))
  - 60FDh(Digital input) bit0(negative limit switch(NOT))
  - External input (POT/NOT)

The setting of 607Eh (Polarity) is reflected on data on the setup support tool PANATERM, in addition to the above data.

And the settings of 607Eh (Polarity) is reflected on POT/NOT during execution by PANATERM including test run function, frequency response analyzing function and Z phase search function. Be careful that these operations are different from those of the MINAS-A5B series.

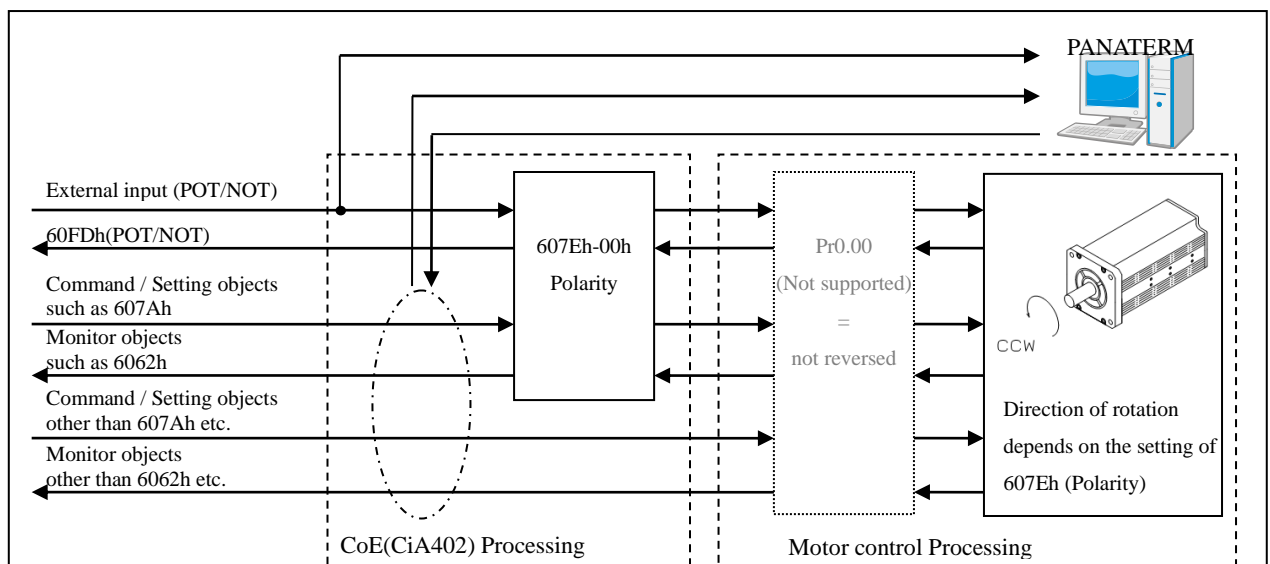

#### 4-2 Position control

Control the position based on the positional command of EtherCAT communication object from the host controller. Below describes the basic settings necessary for position control.

The control mode is switched forcibly inside the driver depending on its operating status irrespective of the command from the host controller.

[Conditions that the control mode is switched forcibly inside the driver]

- When frequency characteristic is measured by Setup support software.  
(Position loop characteristics is position control, the speed closed loop characteristic and torque speed (vertical) are speed control, torque speed (normal) is torque control.)
- Test run of the setup support software (Forcibly position control mode).
- The states that are written "Forcibly controls the position" in "Deceleration stop sequence" (Section 6-3).
- "Retracting operation" in operation (Forcibly controls the position)

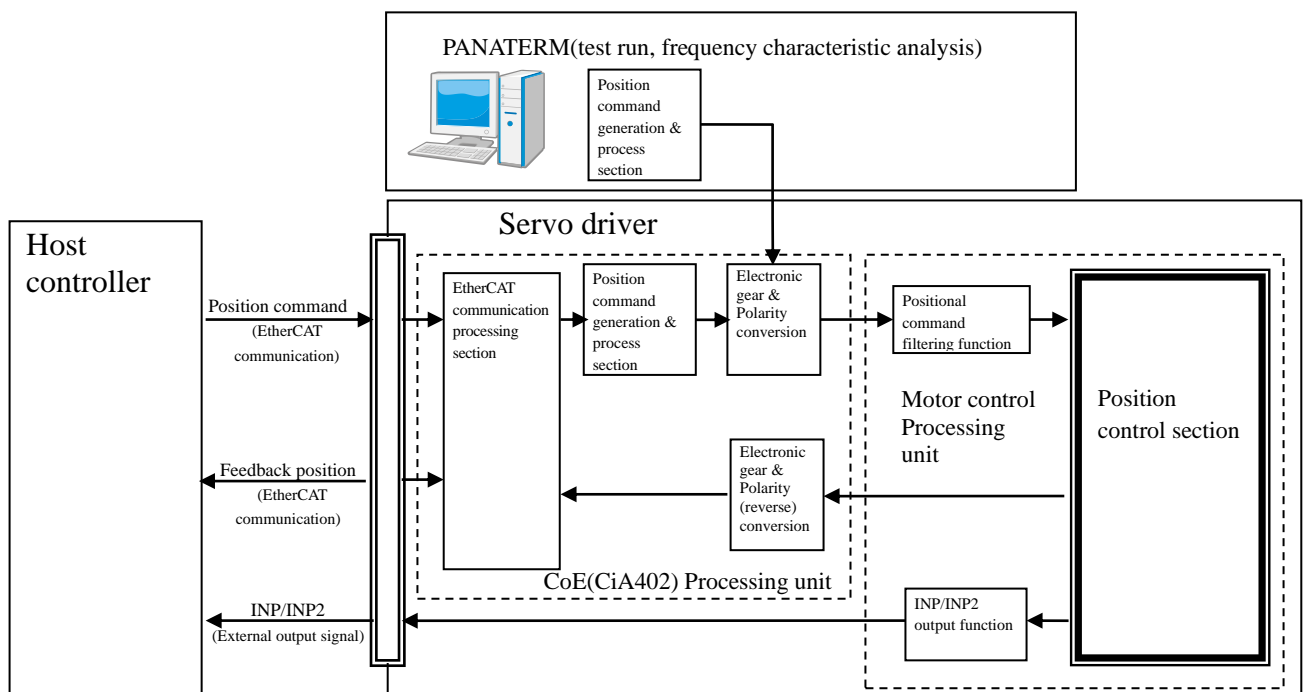

##### 4-2-1 Process of command pulse input

Positional command is input based on the EtherCAT communication object.

As position control modes, Profile position control (pp), Cyclic position control (csp), Interpolated position (ip) (Not supported), and Homing position (hm) are available.

For details, refer to Technical Reference, SX-DSV03242"Section 6-6", EtherCAT communication specification.

#### 4-2-2 Electronic gear function

The electronic gear is a function which makes the value which multiplies by the electronic gear ratio defined by the object to the position command from host controller as the position command to a position control section.

By using this function, the number of revolutions and travel of the motor per command can be set to the desired value.

In MINAS-A6B series, a setup of an electronic gear ratio with a parameter Pr0.08(Number of command pulses per motor revolution), Pr0.09(Numerator of electronic gear) and Pr0.10(Denominator of electronic gear) has not supported, an electronic gear ratio is set up by the object 608Fh(Position encoder resolution), 6091h(Gear ratio) and 6092h(Feed constant) specified to CoE(CiA402).

The equation below calculates the relationship between the unit (command) defined by the user and internal unit (pulse):

$$\text{Electronic gear ratio} = \frac{\text{Position encoder resolution} \times \text{Gear ratio}}{\text{Feed constant}}$$

$$\text{Position demand value} \times \text{Electronic gear ratio} = \text{Position demand internal value}$$

- (Note)
- Electronic gear ratio is valid only within the range of 8000 times to 1/1000 times.  
When the range is exceeded, the value is saturated in the range, and Err88.3 (Improper operation error protection) occurs.
  - When the denominator or numerator exceeds the unsigned 64-bit size in the calculation process of electronic gear ratio, Err88.3 (Improper operation error protection) occurs.
  - When the denominator or numerator exceeds the unsigned 32-bit size in the final calculation result of electronic gear ratio, Err88.3 (Improper operation error protection) occurs.
  - Set the electronic gear ratio with several objects.  
An error may become large depending on the combination of settings.
  - 608Fh-01h (Encoder increments) is automatically set according to encoder resolution.  
Under full-closed control, it is also automatically set according to encoder resolution.  
The default value of 6092h-01h (Feed) is set so that the electronic gear ratio is 1:1 when a 23-bit/r encoder is used.  
When using other encoders than a 23-bit/r encoder, pay attention to the electronic gear ratio settings.
  - The electronic gear ratio setting is reflected at the following timing.  
Pay attention that the setting is not reflected to behavior just by only changing setting value of related objects.
    - At the time of the control power supply ON
    - When establishing communication (when changing ESM state from Init to PreOP)
    - When returning to origin is completed
    - When clearing absolute multi-turn from PANATERM or EtherCAT communication
    - When PANATERM operation(test run function, frequency response analyzing function, Z phase search, fit gain) is completed.
    - When execute pin assign by PANATERM.
    - When Err27.4 (Command error protection) occurs
  - In the position information initialization when Init to PreOp in the absolute mode, make a setting so that the value of "Absolute encoder position [pulse/unit]/Electronic gear ratio" is in the range from  $-2^{31}$  (-2147483648) to  $+2^{31}-1$  (2147483647).  
If the value is exceeded this range, Err29.1(Counter overflow protection 1) will occur.  
Check the operation range of the absolute encoder position and the electronic gear ratio.
  - The unit of the movement amount setting of the test run function by the setup support tool PANATERM is [command unit].  
Pay attention that this is different from those of the MINAS-A5B series.
  - Communication cycle 125μs is supported only if the electronic gear ratio is 1:1.  
Operations when the electronic gear ratio is other than 1:1 are not guaranteed.

For details, refer to Technical Reference, SX-DSV03242"Section 6-9-4", EtherCAT communication specification.

## &lt;Electronic gear setting example&gt;

In MINAS-A6B series, it is impossible to set the electronic gear using the “number of command pulses per motor revolution (Pr0.08)” and “electronic gear numerator (Pr0.09)/denominator (Pr0.10)” in contrast to MINAS-A6N series.

When setting the electronic gear like the MINAS-A6N, refer to the following.

- Under semi-closed control, When setting the electronic gear ratio by setting the number of command pulses per motor revolution

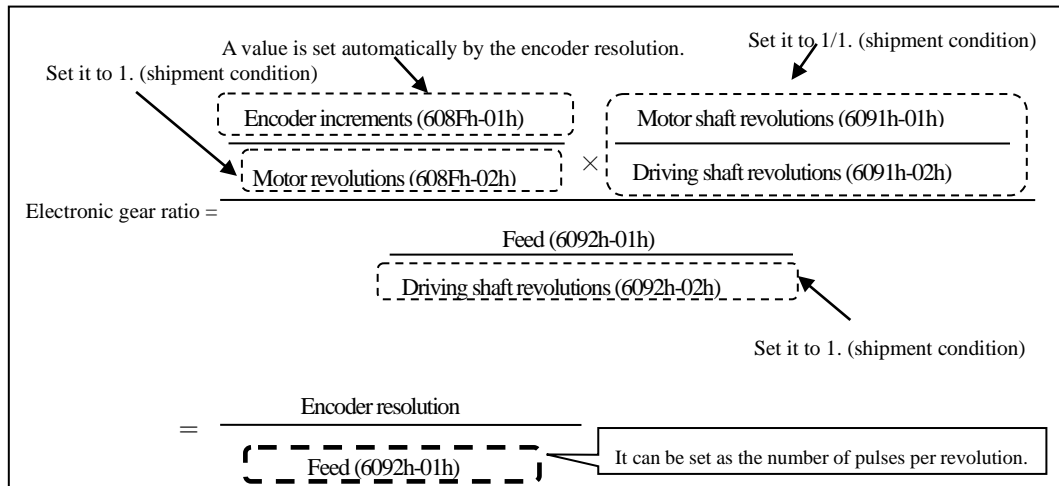

608Fh-01h (Encoder increments) is set automatically from the connected encoder resolution.

By setting 608Fh-02h (Motor revolutions), 6091h-01h (Motor shaft revolutions), 6091h-02h (Driving shaft revolutions) and 6092h-02h (Driving shaft revolutions) to 1 (shipment condition),

it is possible to set 6092h-01h (Feed) as the “number of command pulses per motor revolution”.

- Under semi-closed control or full-closed control, When setting the electronic gear ratio by setting the electronic gear numerator/denominator

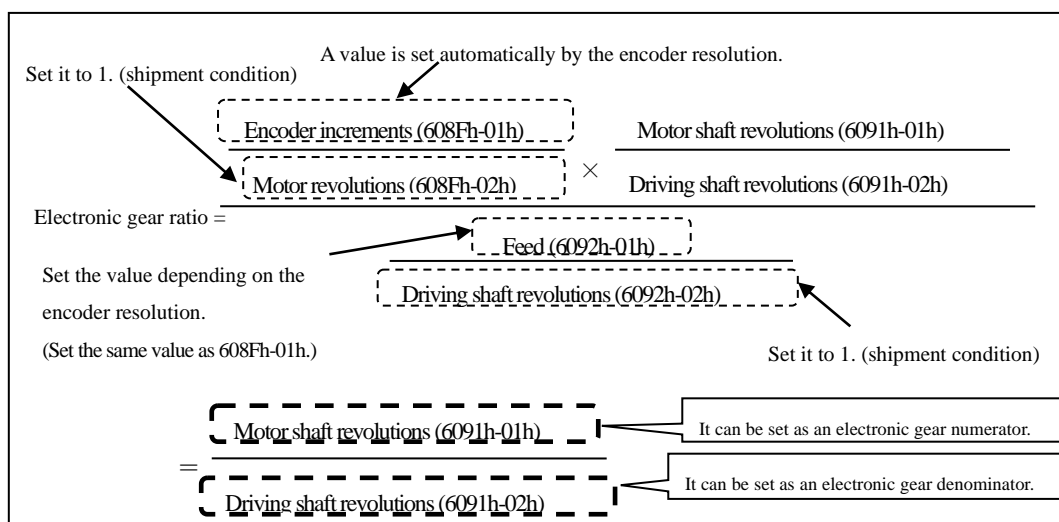

608Fh-01h (Encoder increments) is set automatically from the connected encoder resolution.

By setting 6092h-01h (Feed) to the encoder resolution (the same value as 608F-01h (Encoder increments), and in the case of the 23bit/r encoder, the shipment condition) and setting 608Fh-02h (Motor revolutions) and 6092h-02h (Driving shaft revolutions) to 1 (shipment condition),

it is possible to set 6091h-01h (Motor shaft revolutions) to the “electronic gear numerator” and 6091h-02h (Driving shaft revolutions) to the “electronic gear denominator”.



## &lt;Backup of electronic gear set value&gt;

The electronic-gear-related objects (6091h-01h, 6091h-02h, 6092h-01h and 6092h-02h) are backup target objects.

It is recommended to execute a backup (writing into EEPROM) after a change.

By executing a backup, it will be unnecessary to change setting each time when the control power is turned on.

As for the backup method, refer to Technical Reference, EtherCAT communication specification(SX-DSV03242) Section 5-6 “Store parameters (EEPROM writing of objects) (1010h)”.

## &lt;Electronic gear setting and backup by object editor&gt;

It is possible to set and back up objects using the object editor of PANATERM.

For the MINAS-A5B series, it was necessary to turn the control power ON again after backing up to reflect the setting value changed by using the object editor.

For the MINAS-A6B series, the setting values by using the object editor are reflected to actual objects, and setting of electronic gear ratio is reflect to actual behavior at following timing same as previously via EtherCAT:

- At the time of the control power supply ON
- When establishing communication (when changing ESM state from Init to PreOP)
- When returning to origin is completed
- When clearing absolute multi-turn from PANATERM or EtherCAT communication
- When PANATERM operation(test run function, frequency response analyzing function, Z phase search, fit gain) is completed.
- When execute pin assign by PANATERM.

Pay attention that the changes of the setting values are reflected on operations even if the control power is not turned ON after backup unlike the behavior of the MINAS-A5B series.

R11.0

## 4-2-3 Positional command filtering function

To smooth the positional command processed by the electronic gear, set the command filter.

■ Relevant parameters

Class	No.	Attribute *1)	Title	Range	Unit	Function
2	22	B	Positional command smoothing filter	0–10000	0.1 ms	Set up the time constant of the 1st delay filter in response to the positional command. With the two-degree-of-freedom control, it functions as the command response filter. For the details, refer to 5-2-16 "Two-degree-of-freedom control mode (With position control)" and 5-2-17 "Two-degree-of-freedom control mode (With velocity control)" and 5-2-18 "Two-degree-of-freedom control mode (With full-closed control)".
2	23	B	Positional command FIR filter	0–10000	0.1 ms	Set up the time constant of the FIR filter in response to the positional command

\*1) For parameter attribute, refer to Section 9-1.

• Pr 2.22 Positional command smoothing filter

During conventional control, when a square wave command for the target speed  $V_c$  is applied, set up the time constant of the 1st delay filter as shown below. Set the time constant for the command filter during 2 degrees of freedom control.

For details, refer to Section 5-2-16, 5-2-17, and 5-2-18.

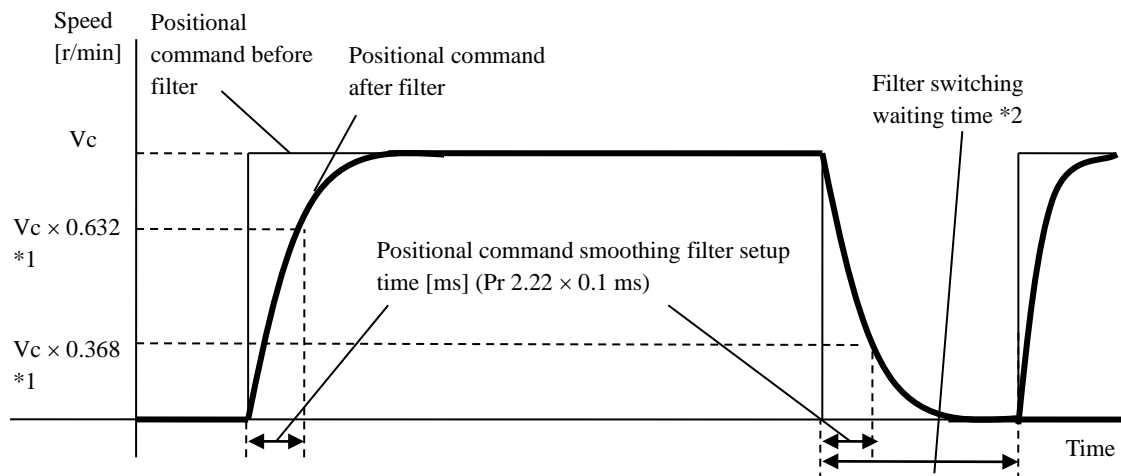

\*1 Actual filter time constant (setup value  $\times 0.1 \text{ ms}$ ) has the maximum absolute error of 0.4 ms for a time constant below 100 ms and the maximum relative error of 0.2% for a time constant 20 ms or more.

\*2 Switching of Pr 2.22 Positional command smoothing filter is performed on the rising edge of the command with the number of command pulses/0.125 ms is changed from 0 to a value other than 0 while the positioning complete is being output. Even if the control mode is changed to position control after Pr2.22 (Positional command smoothing filter) setting is changed during velocity control or torque control, the setting is not changed. If the filter time constant is decreased and positioning complete range is increased, and a many number of pulses are accumulated in the filter (the area equivalent of "value of positional command before filter–value of positional command after filter" integrated over the time), at the time of switching, these pulses are discharged at a higher rate, causing the motor to return to the previous position—the motor runs at a speed higher than the command speed for a short time.

\*3 Even if setting of Pr2.22 (Positional command smoothing filter) is changed, it is not immediately applied to the internal calculation. If the switching as described in \*2 occurs during this delay time, the change of Pr2.22 will be suspended.

- Pr2.23 Positional command FIR filter

When a square wave command of target speed  $V_c$  is applied, set up the  $V_c$  arrival time as shown in the figure below.

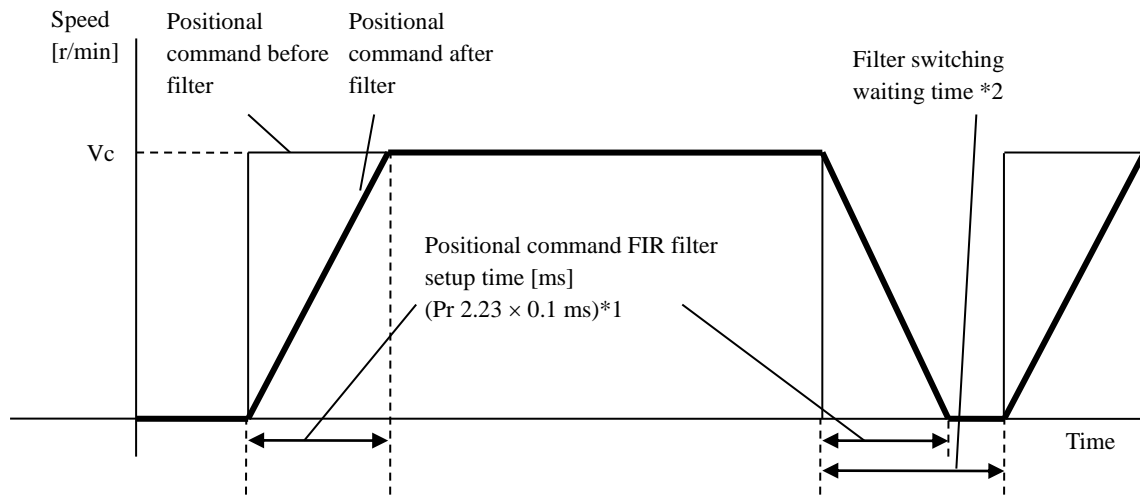

- \*1 The actual average travel time (setup value × 0.1 ms) has the maximum absolute error of 0.2 ms for a time constant below 10 ms and the maximum relative error of 1.6% for a time constant 10 ms or more.
- \*2 When changing the setting of Pr2.23 (Positional command FIR filter), stop the command pulse and wait until the filter switching wait time has elapsed. The filter switching wait time will be setup value × 0.1 ms + 0.25 ms when the setup time is below 10 ms, or setup value × 0.1 ms × 1.05 when the setup time is over 10 ms. If Pr 2.23 is changed during the command pulse is being input, the change is not reflected until the command pulse-less state has continued for the filter switching wait time. Change will be reflected after the control power reset.
- \*3 Even if setting of Pr2.23 (Positional command FIR filter) is changed, it is not immediately applied to the internal calculation. If the switching as described in \*2 occurs during this delay time, the change of Pr2.23 will be suspended.

When the positional command is trapezoidal wave, its waveform will be shaped to S at the output of the filter.

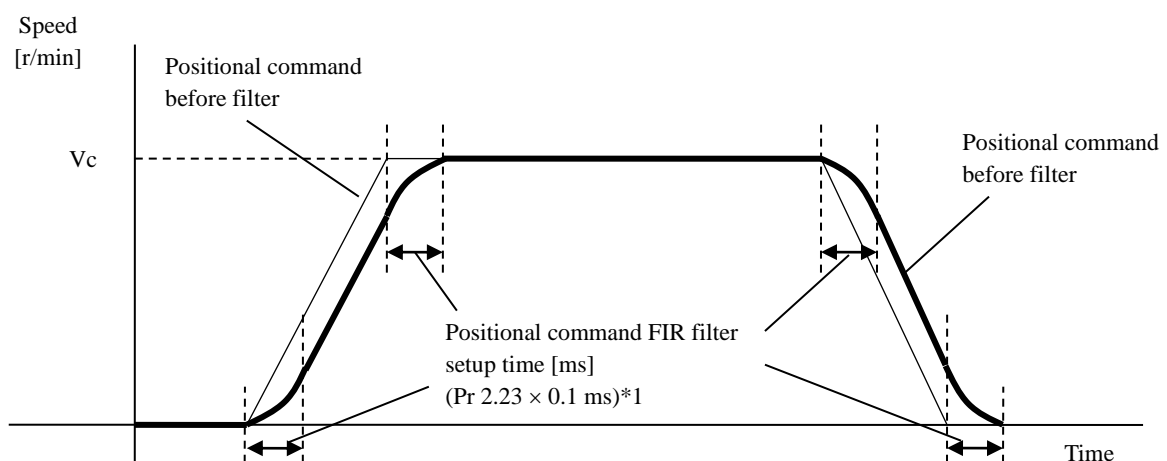

## 4-2-4 Positioning complete output (INP/INP2) function

The completion of positioning can be verified by the positioning complete output (INP) or the positioning complete output 2 (INP2).

When the absolute value of the positional deviation counter at the position control is equal to or below the positioning complete range by the parameter, the output is ON. Presence and absence of positional command can be specified as one of judgment conditions.

The calculation methods (standard) of a position deviation differ as follows according to the setting for the command position deviation output switching (bit 14) of Pr7.23 "Communication function Extended setup 2".

For details, refer to Section 3-4.

Pr7.23 bit14=0: Deviation with respect to command input after positional command filter

Pr7.23 bit14=1: Deviation with respect to command input before positional command filter

However, it becomes available when Pr5.20(Position setup unit select) is 0.

Note: The "positional deviation" written in this section is that of the motor control process part (on PANATERM and analog monitor), not 60F4h (Following error actual value) on the EtherCAT communication.

■ Relevant parameters

Class	No.	Attribute *1)	Title	Range	Unit	Function
4	31	A	Positioning complete (In-position) range	0–2097152	Command unit	Set the threshold of positional deviation with respect to the output of positioning complete signal (INP). The unit of shipment setting is [Command unit], but it can be changed to [Encoder unit] or [External scale unit] by Pr5.20(Position setup unit select). In this case, the unit of Pr0.14 is changed too, please attention. The positional deviation value can be changed to after or before position command filter by Pr7.23 bit14.
4	32	A	Positioning complete (In-position) output setup	0–10	—	Select the condition to output the positioning complete signal (INP). Whether or not positional commands are set is judged by the command after the positional command filter in the case of settings 1 to 5, and the command before the positional command filter in the case of 6 to 10. For the value of the position deviation it is possible to switch before or after the position command filter by Pr7.23 bit14. 0: The signal will turn on when the positional deviation is smaller than Pr 4.31 (Positioning complete range) 1, 6 :The signal will turn on when there is no position command and the positional deviation is smaller than Pr 4.31 (Positioning complete range). 2, 7 :The signal will turn on when there is no position command, the zero-speed detection signal is ON and the positional deviation is smaller than Pr 4.31 (Positioning complete range). 3, 8 :The signal will turn on when there is no position command and the positional deviations smaller than Pr 4.31 (Positioning complete range). Subsequently, ON state is maintained until Pr 4.33 INP hold time has elapsed. After the hold time, INP output will be turned ON/OFF according to the coming positional command or condition of the positional deviation. 4, 9 :Positioning completion decision starts in a delay time specified by Pr4.33 after a change from "With command" to "Without command". The signal turns on if position command is not received and position deviation is not larger than Pr4.31. 5,10 :After "With position command" changes to "Without position command" and then the positional deviation enters the positioning complete range, positioning completion decision is started upon the elapse of the positioning determination delay time specified for Pr4.33 "INP hold time". The signal turns on when there is no position command and the positional deviation is equal to smaller than Pr 4.31 "Positioning complete range".

Class	No.	Attribute *1)	Title	Range	Unit	Function
4	33	A	INP hold time	0-30000	ms	<p>Set up the hold time when Pr 4.32 = 3, 8.</p> <p>0: The hold time is maintained definitely, keeping ON state until the next positional command is received.</p> <p>1 to 30000: ON state is maintained for setup time (ms) but switched to OFF state as the positional command is received during hold time.</p> <p>Becomes positioning detection delay time when Pr4.32 = 4, 5, 9, 10.</p> <p>0: Positioning detection delay time becomes 0, and positioning completion decision is started immediately upon a change from "With position command" to "Without position command".</p> <p>1 to 30000: Positioning decision start time is delayed by a setting value [ms]. If a position command is received during the delay time, the delay time is reset. When the position command becomes 0, the delay time starts to be measured starting from 0.</p>
4	42	A	Positioning complete (In-position) range 2	0-2097152	Command unit	<p>Set the threshold of positional deviation with respect to the output of positioning complete (INP) signal.</p> <p>The INP2 turns ON whenever the positional deviation is lower than the value set up in this parameter, without being affected by Pr 4.32</p> <p>Positioning complete output setup. (Presence/ absence of positional command is not related to this judgment.)</p> <p>The unit of shipment setting is [Command unit], but it can be changed to [Encoder unit] or [External scale unit] by Pr5.20(Position setup unit select).In this case, the unit of Pr0.14 is changed too, please attention.</p> <p>The positional deviation value can be changed to after or before position command filter by Pr7.23 bit14.</p>
5	20	C	Position setup unit select	0-1	—	<p>Specify the unit to determine the range of positioning complete and excessive positional deviation.</p> <p>0: Command unit, 1: Encoder unit (External scale unit)</p> <p>Note: Positioning complete(6041h bit10(Target reached)) detection threshold of EtherCAT communication status is always in terms of command unit regardless of the setting of this parameter.</p>
7	23	B	Communication function extended setup 2	-32768 -32767	—	<p>bit14: Position deviation [command unit] output setting</p> <p>0: Internal command position (after filtering) [command unit] – Actual position [command unit]</p> <p>1: Internal command position (before filtering) [command unit] – Actual position [command unit]</p>

\*1) For parameter attribute, refer to Section 9-1.

## 4-2-5 Pulse regeneration function

The information on the amount of movement can be sent to the host controller in the form of A- and B-phase pulses from the servo driver. The resolution of information, B phase logic and output source (encoder and external scale) can be set up by using parameters.

Z phase signal is not supported with pulse regeneration.

■ Relevant parameters

Class	No.	Attribute *1)	Parameter	Range	Unit	Function
0	11	R	Output pulse counts per one motor revolution	1–2097152	pulse/r	Set the resolution of pulse output by the number of output pulses per revolution of OA and OB, respectively. When the host counts pulses after multiplying by 4, resulting count is as follows: Pulse output resolution per revolution = Pr. 0.11 setting value × 4.
0	12	R	Reversal of pulse output logic/output source selection	0–3	—	Set the B-phase logic and the output source of the pulse output. By inverting the B-phase pulse by this parameter, it is possible to reverse the phase relationship between the B-phase pulses to the A-phase pulse. Either encoder or external scale can be selected for output source when external scale position information monitor function is valid under full-closed control or semi-closed control. Encoder is selected in case other than full-closed control and where external scale position information monitor function is invalid under semi-closed control.
4	47	R	Pulse output selection	0–1	—	Select the signal to be output from the pulse regeneration output terminal or position comparison output terminal. 0: Encoder output signal 1: Position comparison output signal
5	3	R	Denominator of pulse output division	0–8388608	—	For application where the number of output pulses is not an integer, this parameter can be set to a value other than 0 and the dividing ratio can be set by using Pr. 0.11 as numerator and Pr. 5.03 as denominator. When the host counts pulses after multiplying by 4, resulting count is as follows: Pulse output resolution per revolution = (Pr. 0.11 setting value/Pr.5.03 setting value) × encoder resolution
5	33	C	Pulse regenerative output limit setup	0–1	—	Enable/disable detection of Err28.0 “Pulse regenerative limit protection”. 0: Invalid 1: Valid
6	22	R	A, B phase external scale pulse output method selection	0–1	—	Selects pulse regenerated output of ABZ parallel external scale. 0: Outputs AB phase signal from ABZ parallel external scale as is. 1: Regenerates and outputs AB phase signal from ABZ parallel external scale.

\*1) For parameter attribute, refer to Section 9-1.

The table below shows combination of Pr0.11 “Output pulse counts per one motor revolution” and Pr5.03 “Denominator of pulse output division”.

Pr 0.11	Pr 5.03	Command division/multiplication operation
1-2097152	0	<p style="text-align: center;"><b>[When the output source is encoder]</b></p> <p>Encoder pulse [pulse] → <math>\frac{[\text{Pr.0.11 setting value}] \times 4}{\text{Encoder resolution}}</math> → Output pulse [pulse]</p> <ul style="list-style-type: none"> <li>When Pr 5.03 = 0, the above process is made according to Pr 0.11 setup value. The number of pulses of reproduced pulse output OA and OB are the number of pulses set in Pr 0.11. The resolution of pulse output per one revolution is equal to or less the encoder resolution.</li> </ul> <p style="text-align: center;"><b>[When the output source is external scale]</b></p> <p>External scale pulse [pulse] → <math>\frac{1}{1}</math> → Output pulse [pulse]</p> <ul style="list-style-type: none"> <li>When Pr.5.03 = 0, division ratio is 1:1.</li> </ul>
		<p>Encoder pulse or External scale pulse [pulse] → <math>\frac{[\text{Pr.0.11 setting value}]}{[\text{Pr.5.03 setting value}]}</math> → Output pulse [pulse]</p> <ul style="list-style-type: none"> <li>If Pr 5.03 is not equal to 0, then the above process is performed based on setup value of Pr 0.11 and Pr 5.03. This process enables the system to be compatible with application where the number of pulses per motor revolution of reproduced pulse output OA and OB are not an integral. However, the resolution of output pulse is equal to the resolution of encoder pulse at the best.</li> </ul>

Table below shows details of Pr. 0.12 “Reversal of pulse output logic/output source selection”.

Pr 0.12	B-phase logic	Output source	CCW direction rotation	CW direction rotation
0	Nonreversal	Encoder	A-phase	A-phase
2		External scale	B-phase	B-phase
1	Reversal	Encoder	A-phase	A-phase
3		External scale	B-phase	B-phase

\* Setting values 2 and 3 are effective only under one of the conditions below.

Under the conditions other than the below, set setting values to 0 and 1.

- In full-closed control mode
- In semi-closed control mode and external scale position information monitor function is effective

■ Command on pulse regeneration function

- Maximum frequency of regenerated pulse output is 4 Mpps (after multiplied by 4). If the movement speed exceeds this frequency, the regeneration will not function correctly. That is, correct pulse is not returned to the host controller, causing positional deviation.

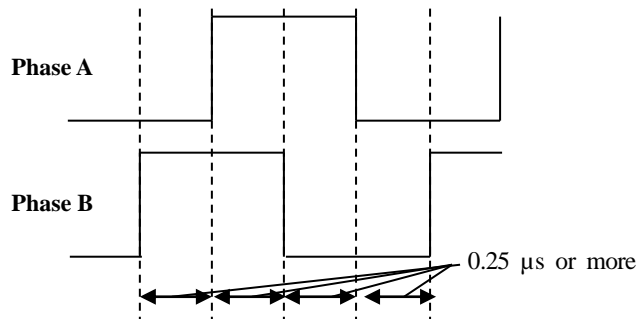

By enabling Pr5.33 “Pulse regenerative output limit setup”, Err28.0 “Pulse regenerative limit protection” can be generated upon reaching the pulse regeneration limit. Because this error is generated when the output limit of the pulse regeneration is detected, it is not generated at the maximum frequency. However, detection error may occur if the frequency instantaneously jumps up due to motor velocity change (irregular rotation).

- In the pulse regeneration function, the set value of Polarity (607Eh) when control power supply has been turned on is reflected.



## 4-3 Velocity control

Carried out the speed control based on the speed command object EtherCAT communication which is input from the host controller.

This describe the basic configuration when using the speed control.

As the speed control mode, there is a Profile velocity control(pv) and Cyclic synchronous velocity control(csv).

For details, refer to Technical Reference, SX-DSV03242"Section 6-7", EtherCAT communication specification.

The control mode is switched forcibly inside the driver depending on its operating status irrespective of the command from the host device. This operation has an effect on input signal processing.

[Conditions that the control mode is switched forcibly inside the driver]

- When frequency characteristic is measured by Setup support software.  
(Position loop characteristics is position control, the speed closed loop characteristic and torque speed (vertical) are speed control, torque speed (normal) is torque control.)
- Test run of the setup support software (Forcibly position control mode).
- The states that are written "Forcibly controls the position" in "Deceleration stop sequence" (Section 6-3).
- "Retracting operation" in operation (Forcibly controls the position)

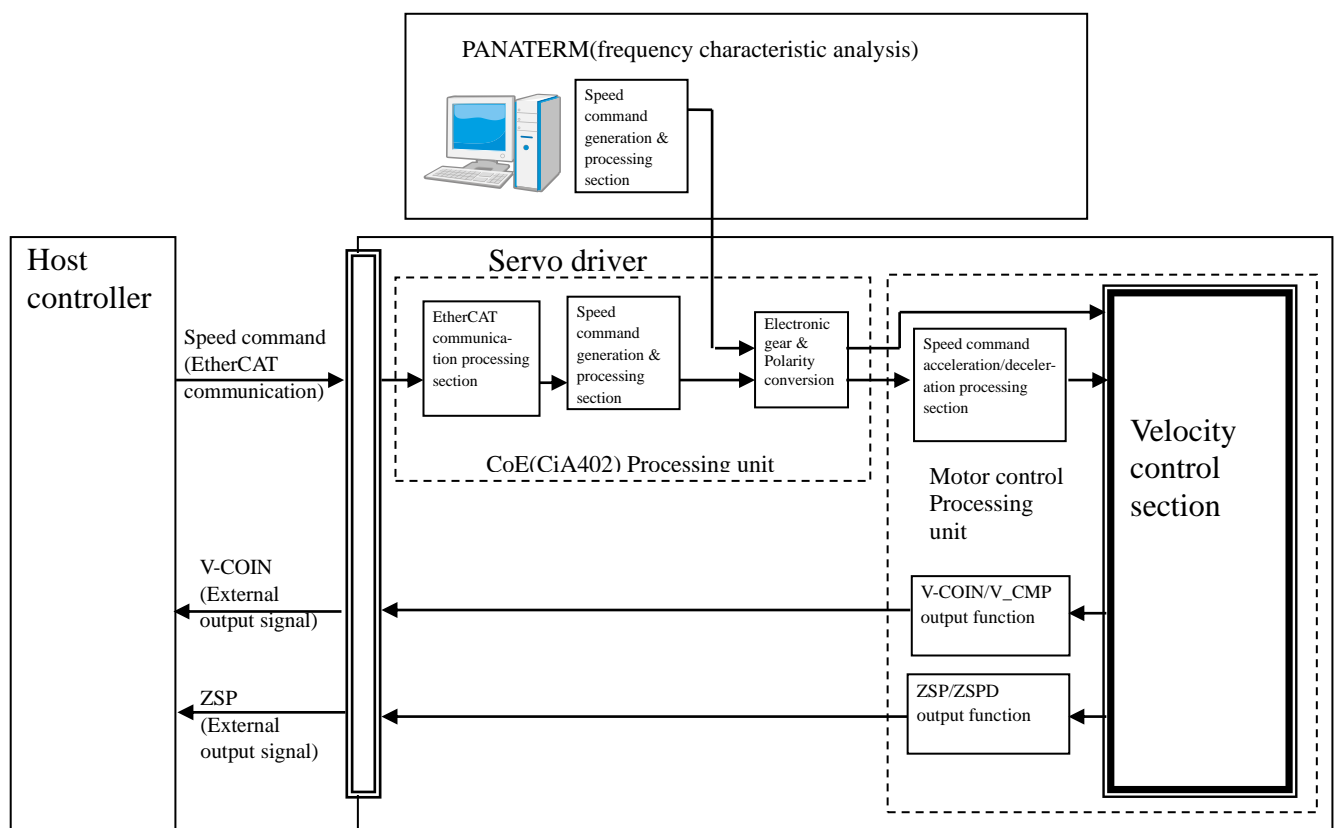

## 4-3-1 Attained speed output (AT-SPEED)

The AT-SPEED signal is output as the motor reaches the speed set to Pr 4.36 "Attained speed".

■ Relevant parameters

Class	No.	At-tribute *1)	Title	Range	Unit	Function
4	36	A	At-speed (Speed arrival)	10–20000	r/min	Set the detection timing of the speed arrival output (AT-SPEED). When the motor speed exceeds this setup value, the speed arrival output (AT-SPEED) is output. Detection is associated with 10 r/min hysteresis.

\*1) For parameter attribute, refer to Section 9-1.

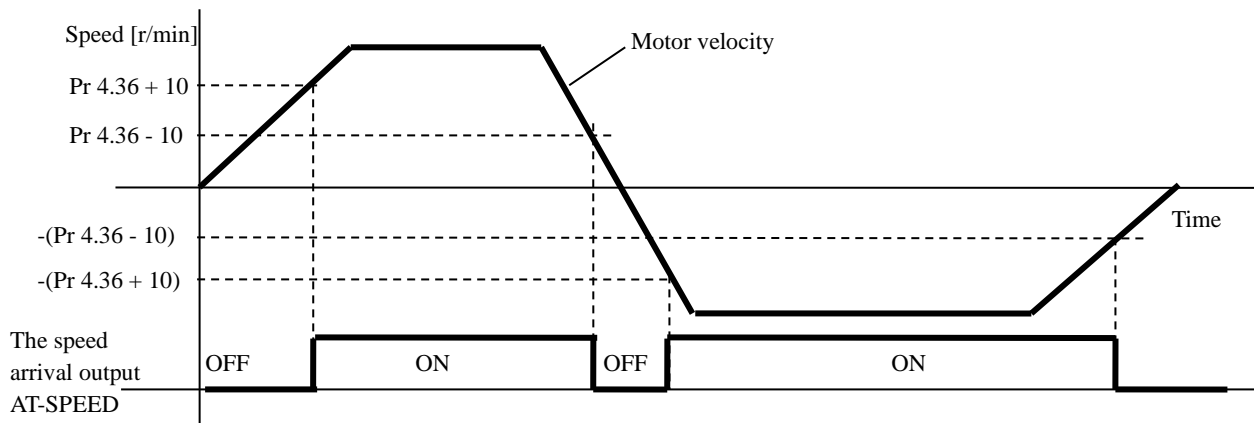

## 4-3-2 Speed coincidence output (V-COIN)

This signal is output when the motor speed is equal to the velocity specified by the velocity command. The motor speed is judged to be coincident with the specified speed when the difference from the velocity command before/after acceleration/deceleration is within the range specified by Pr 4.35 "Speed coincident range"

## ■ Relevant parameters

Class	No.	Attribute *1)	Title	Range	Unit	Function
4	35	A	Speed coincidence range	10–20000	r/min	Set the speed coincidence (V-COIN) output detection timing. Output the speed coincidence (V-COIN) when the difference between the speed command and the motor speed is equal to or smaller than the speed specified by this parameter. The detection response has 10 r/min hysteresis.

\*1) For parameter attribute, refer to Section 9-1.

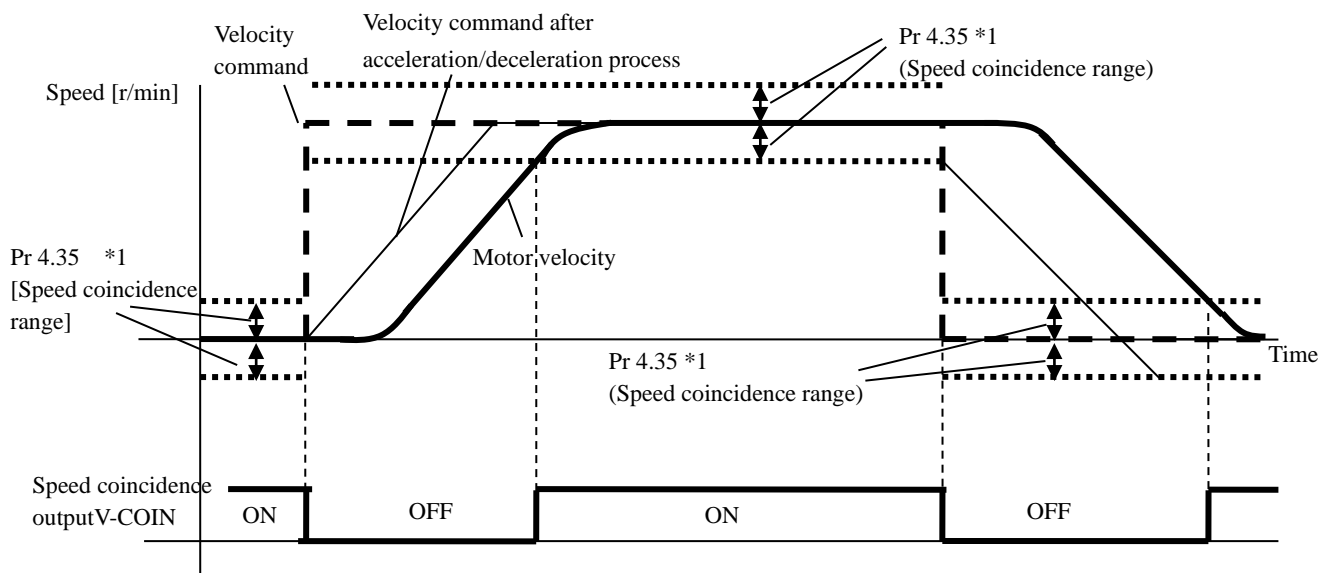

\*1 Because the speed coincidence detection is associated with 10 r/min hysteresis, actual detection range is as shown below.

Speed coincidence output OFF ON timing (Pr 4.35 – 10) r/min

Speed coincidence output ON OFF timing (Pr 4.35 + 10) r/min

## 4-3-3 Velocity command acceleration/deceleration setting function

This function controls the velocity by adding acceleration or deceleration command in the driver to the input velocity command. Using this function, you can use the soft start when inputting stepwise velocity command or when using internal velocity setup. You can also use S shaped acceleration/deceleration function to minimize shock due to change in velocity.

## ■ Relevant parameters

Class	No.	Attribute *1)	Title	Range	Unit	Function
3	12	B	Acceleration time setup	0-10000	ms/ (1000 r/min)	Set up acceleration processing time in response to the velocity command input.
3	13	B	Deceleration time setup	0-10000	ms/ (1000 r/min)	Set up deceleration processing time in response to the velocity command input.
3	14	B	Sigmoid acceleration/deceleration time setup	0-1000	ms	Set S-curve time for acceleration/deceleration process when the velocity command is applied.

\*1) For parameter attribute, refer to Section 9-1.

Note: When the position loop is external to the driver, do not use the acceleration/deceleration time setting. Set these values to 0.

• Pr 3.12 “Acceleration time setup”, Pr 3.13 “Deceleration time setup”

Set the time, elapsing before the velocity command (stepwise input) reaches 1000 r/min after a stepwise velocity command is input, to Pr 3.12 “Acceleration time setup”. Also set the time, elapsing before the velocity command reaches 0 r/min from 1000 r/min, to Pr 3.13 “Deceleration time setup”. Assuming that the target value of the velocity command is  $V_c$  (r/min), the time required for acceleration/deceleration can be computed from the formula shown below.

$$\text{Acceleration time (ms)} = V_c/1000 \times \text{Pr 3.12} \times 1 \text{ ms}$$

$$\text{Deceleration time (ms)} = V_c/1000 \times \text{Pr 3.13} \times 1 \text{ ms}$$

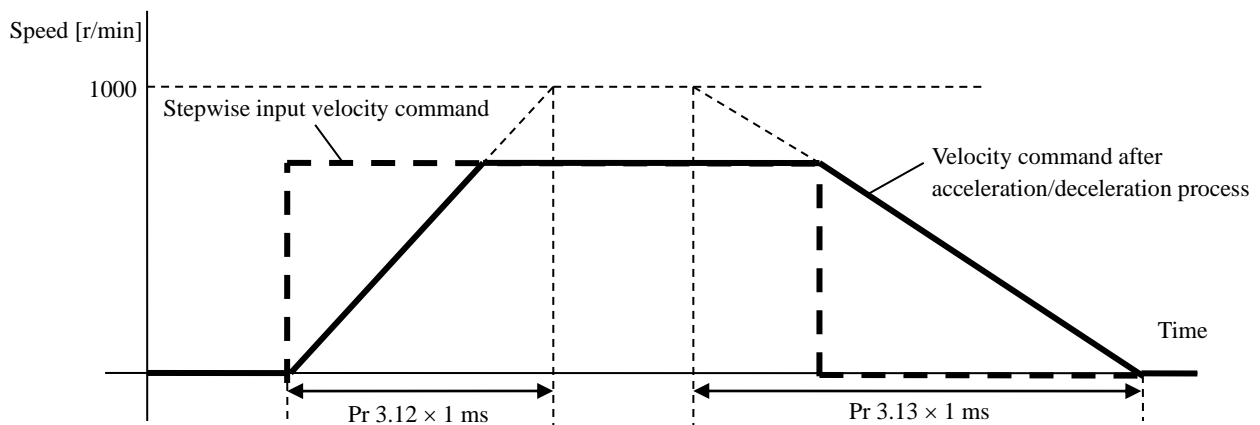

- Pr 3.14 “Sigmoid acceleration/deceleration time setup”

According to Pr 3.12 “Acceleration time setup” and Pr 3.13 “Deceleration time setup”, set up sigmoid time with time width centering the inflection point of acceleration/deceleration.

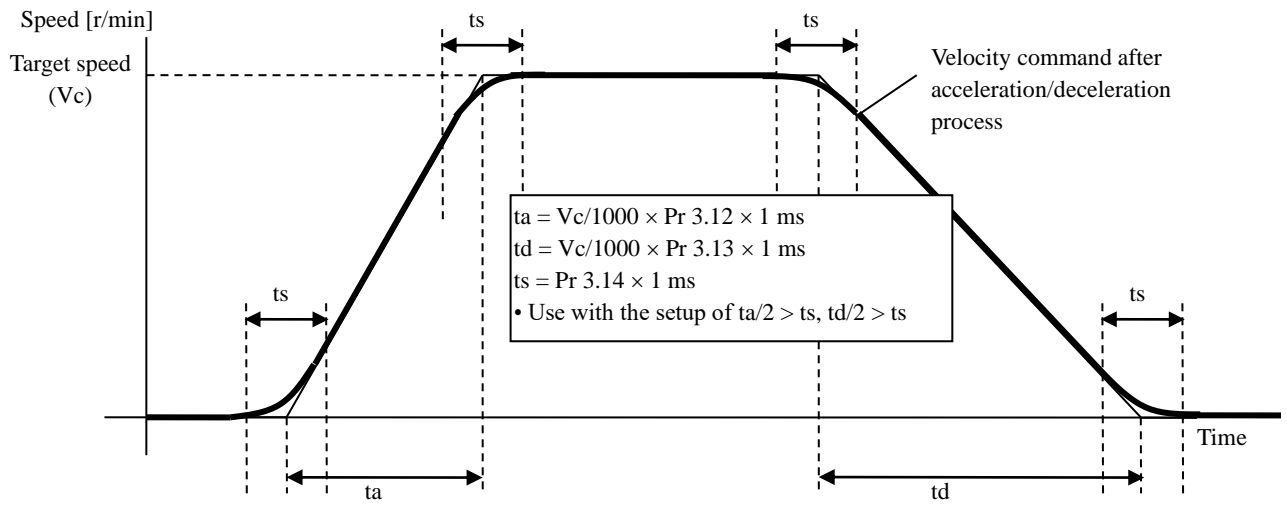

## 4-4 Torque control

Torque control is performed based on the torque command object of the EtherCAT communication which is input from the host controller.

This describe the basic configuration when using the torque control.

Torque control is required speed limit command in addition to the torque command.

Control the rotational speed of the motor so that the value does not exceed the speed limit.

Note) When a torque command is given so that 0 is routed through like a positive value to negative value or negative value to positive value while torque filter is valid, torque may not be controlled according to the torque slope and torque filter settings.

As torque control mode, there is a Profiles torque control (tq) and Cyclic synchronous torque control(cst).

For details, refer to Technical Reference, SX-DSV03242” Section 6-8”, EtherCAT communication specification.

The control mode is switched forcibly inside the driver depending on its operating status irrespective of the command from the host device. This operation has an effect on input signal processing.

[Conditions that the control mode is switched forcibly inside the driver]

- When frequency characteristic is measured by Setup support software.  
(Position loop characteristics is position control, the speed closed loop characteristic and torque speed (vertical) are speed control, torque speed (normal) is torque control.)
- Test run of the setup support software (Forcibly position control mode).
- The states that are written "Forcibly controls the position" in "Deceleration stop sequence" (Section 6-3).
- "Retracting operation" in operation (Forcibly controls the position)

Note) As the two-degree-of-freedom control mode is set to valid in the shipment value, set the two-degree-of-freedom control mode to invalid (Pr6.47 bit0=0) before using the torque control mode in function extended edition 2 or earlier versions.

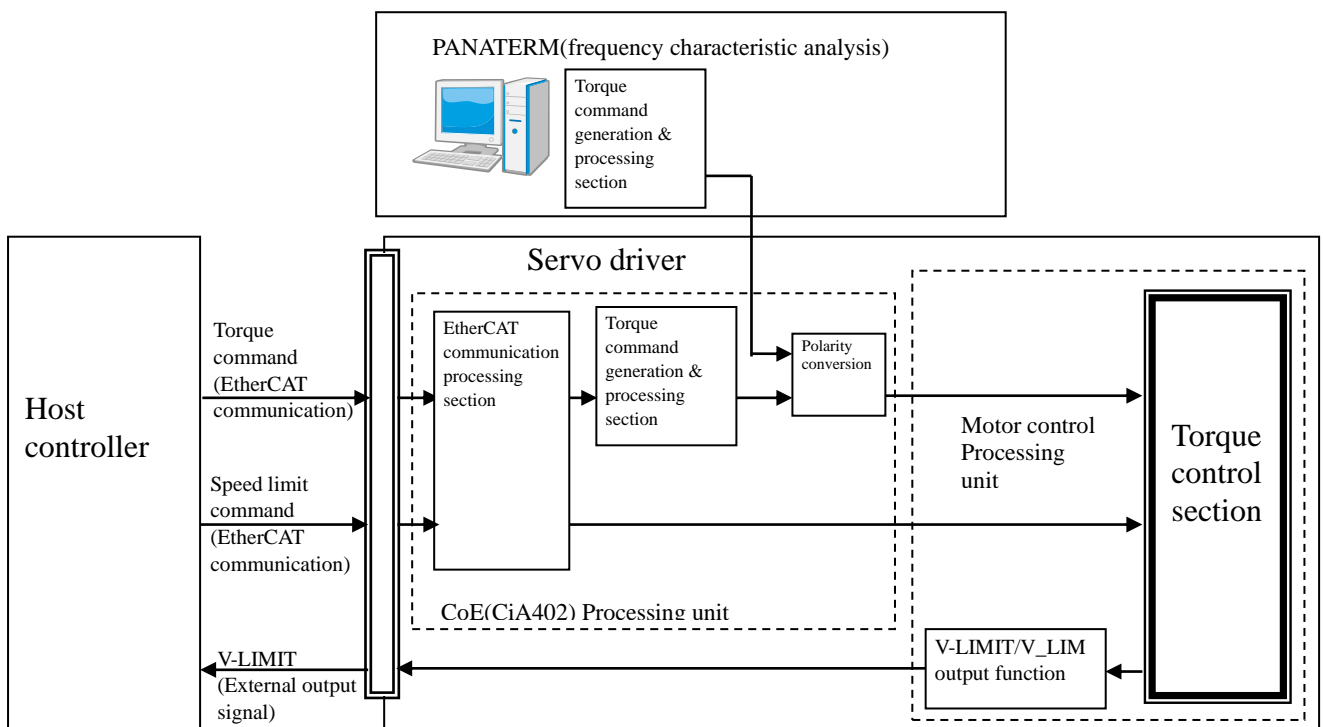

## 4-4-1 Speed limit function

The speed limit is one of protective functions used during torque control.

This function regulates the motor speed so that it does not exceed the speed limit while the torque is controlled.

Note: While the speed limit is used to control the motor, the torque command applied to the motor is not directly proportional to the torque command from host controller.

The torque command applied to the motor becomes the torque that the speed-controlled so that the motor speed becomes the speed limit value.

Note: If the motor runs in the direction opposite to the one specified by the torque command given by the host controller due to disturbance including gravity, the speed will not be within the limit.

If this matters, set the speed at which the motor needs to be stopped in Pr5.13 (over-speed level setting) or Pr6.15 (2nd over-speed protection level setting), so that Err26.0 (over-speed protection) or Err26.1 (2nd over-speed protection) is caused to happen in order to stop the motor.

For details on over-speed protection, refer to the section 6-3-5.

■ Relevant parameters

Class	No.	Attribute *1)	Title	Range	Unit	Function				
3	17	B	Speed limit select	2	—	Set up the selection method of the speed limit used for torque control mode. <table border="1" style="margin-left: 20px;"> <thead> <tr> <th>Setting value</th> <th>Speed limit value</th> </tr> </thead> <tbody> <tr> <td>2</td> <td>6080h (Max motor speed)</td> </tr> </tbody> </table> With this servo driver, it becomes 2 fixation.	Setting value	Speed limit value	2	6080h (Max motor speed)
Setting value	Speed limit value									
2	6080h (Max motor speed)									
6	97	B	Function expansion setting 3	-2147483648 ~ 2147483647	—	bit12 : Velocity limit priority function during torque control 0 : Torque command priority 1 : Velocity limit priority *2)*3)				

\*1) For parameter attribute, refer to Section 9-1.

\*2) It is enabled only for control mode cst.

\*3) If 606Ch (Velocity actual value) exceeds the velocity limit value (607Fh (Max profile velocity) or 6080h (Max motor speed)), torque limit by 60E0h (Positive torque limit value) and 60E1h (Negative torque limit value) is disabled and control is performed by generating necessary torque so that the velocity becomes lower than the limit velocity. However, the maximum torque is 6072h (Max torque).

#### 4-5 Full-closed control

It cannot be used in [A6BE].

Full-closed control is where the position of the unit being controlled is controlled by direct feedback of the detected position using an externally located scale (external scale).

This allows, for example, control that is not affected by ball screw errors or position variation from temperature.

Configuring a full-closed control system will enable the achievement of high-precision positioning of sub-micrometer order.

Full-closed control mode works in position control mode (profile position control (pp), cyclic position control (csp), interpolated position control (ip) (not supported), homing (hm)).

If 6060h (Modes of operation) is set to 3 (pv), 4 (tq), 9 (csv), and 10 (cst) under full-closed control, Err88.1 (Control mode setting error protection) occurs.

It is not possible that switching to velocity control mode (profile velocity control (pv), cyclic velocity control (csv)) or torque control mode (profile torque control (tq), cyclic torque control (cst)) under full-closed control.

This section describes the setting of external scale ratio and the setting of excessive hybrid deviation in the initial setting for full-closed control.

#### Caution

- (1) One command pulse(one command unit) of when the command division/multiplication ratio is 1:1 becomes as one pulse of external scale.  
With the full-closed control, the velocity control is implemented by the encoder feedback, and the position control by the external scale feedback.
- (2) Make sure to set Pr3.28 "Hybrid deviation excess setup" and Pr3.29 "Hybrid deviation clear setup" to appropriate values.  
When the hybrid deviation excess range is set excessively wide, detection becomes delayed, and the effects of error detection become lost. Please refer to 4-5-3 for details.  
Also, if set excessively narrow the torsion between motor and equipment in normal operation may be detected as an abnormal.
- (3) The external scale of  $1/40 \leq \text{External scale ratio} \leq 125200$  is recommended.  
When the external scale rate is set at the value smaller than 50/position loop gain (Hz), control by the unit of 1 pulse in external scale may not become possible.  
If the external scale ratio is increased, the operating noise may become louder.
- (4) When a wrong external scale division ratio is set, even if the external scale and motor position agree with each other, the Err25.0 "Hybrid deviation excess error protection" may occur especially when the stroke distance is long with the movement. In that case, use with the external scale division ratio set to a value that is as close as possible, and the hybrid deviation excess range expanded.
- (5) Full-closed control cannot be used in 0.250 ms and 0.125 ms of communication cycles.  
If 0.250 ms and 0.125 ms of communication cycles are set under full-closed control, Err91.1 (Command error protection) occurs.



## 4-5-1 Selection of external scale type

This section describes the selection of external scale type to be used and sets the direction.

■ Relevant parameters

Class	No.	Attribute *1)	Title	Range	Unit	Function
3	23	R	External scale selection	0-6	—	<p>Selects the type of external scale.</p> <p>0: A, B phase output type            1: Serial communication type (Incremental specification)            2: Serial communication type (Absolute specification)            3-5 : For manufacturer's use            6 : Serial communication type (absolute spec.) *2)</p> <p>When the A- and B-phase output type is connected, if the value is set to 1, 2 or 6, Err50.0 "External scale connection error protection" occurs.</p> <p>Also, when the serial communication type is connected, if the value is set to 0, Err55.0-55.2 "A-phase or B-phase or Z-phase connection error protection" occurs.</p> <p>Err.93.3 "external scale connection error protection" occurs if 1 is set when a serial communication type scale of absolute specification is connected, if 2 or 6 is set when a serial communication type scale of incremental specification is connected, or if 3, 4 or 5 is set as the setting value regardless of the type of scale connected.</p>
3	26	B	Reversal of direction of external scale	0-3	—	<p>Sets the direction inversion of the external scale feedback counter.</p> <p>0: Non-inversion            1: Inversion            2: For manufacturer's use *2)*3)            3: For manufacturer's use *2)*3)</p>

\*1) For parameter attribute, refer to Section 9-1.

\*2) The setting range is 0 to 1 in versions corresponding to function extended edition 2 or earlier.

\*3) Do not set up the setting range 2 to 3, as it can only be used by the manufacturer.

Pr3.23	External scale type	Supporting scale manufacturers	Supporting velocity *3
0	A, B phase output type *1 *2 *4	External scale of A, B phase output type	to 4M pulse/s (after 4 multiplications)
1	Serial communications type (increment specification) *2 *4	Magnescale Co., Ltd. Nidec Sankyo Corporation	to 4G pulse/s
2	Serial communications type (absolute specification) *2 *4	Mitutoyo Corporation Magnescale Co., Ltd. Heidenhain K.K. Renishaw K.K. Fagor Automation S.Coop	to 4G pulse/s
6	Serial communication type (absolute rotary specification) *2 *4	Fagor Automation S.Coop	to 4G pulse/s

\*1. The counting direction of driver internal processing on the A, B phase output type external scale is shown in the table below.

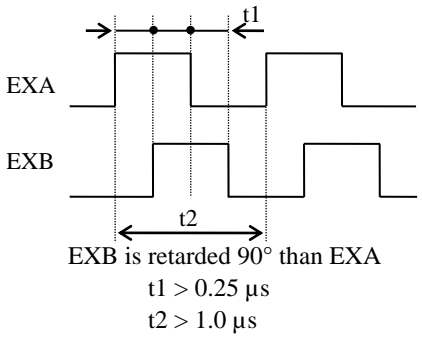
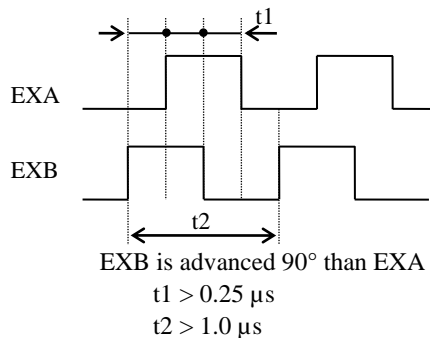
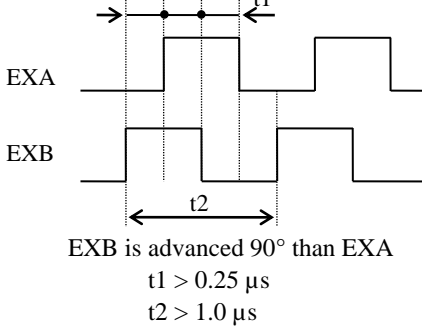
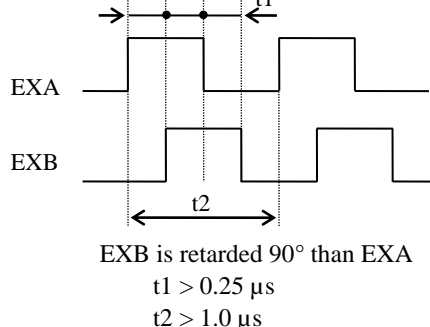
Pr3.26	Count-down direction	Count-up direction
0: Non-inversion	 <p>EXB is retarded 90° than EXA  <math>t1 &gt; 0.25 \mu\text{s}</math>  <math>t2 &gt; 1.0 \mu\text{s}</math></p>	 <p>EXB is advanced 90° than EXA  <math>t1 &gt; 0.25 \mu\text{s}</math>  <math>t2 &gt; 1.0 \mu\text{s}</math></p>
1: Inversion	 <p>EXB is advanced 90° than EXA  <math>t1 &gt; 0.25 \mu\text{s}</math>  <math>t2 &gt; 1.0 \mu\text{s}</math></p>	 <p>EXB is retarded 90° than EXA  <math>t1 &gt; 0.25 \mu\text{s}</math>  <math>t2 &gt; 1.0 \mu\text{s}</math></p>

\*2. For the direction of external scale connection, make sure to connect so that the scale counting direction becomes as the count-up when the motor axis is rotated to the CCW direction, and as the count-down when the motor shaft is rotated to the CW direction. If the above mentioned directions are not possible depending on the installation conditions and others, the scale counting direction can be inverted using Pr3.26 "Reversal of direction of external scale".

The installation direction can be checked USB communication (PANATERM), by checking the counting directions of external scale feedback pulse summation and encoder feedback pulse summation. When they are in agreement, the connection is established correctly. If they do not match, invert the set value of Pr3.26 "Reversal of direction of external scale" (0 -> 1 or 1 -> 0).

\*3. Supporting velocity means the feedback speed [pulse/s] of external scale that can be processed in the driver side.  
 For the information on available range in the scale side, please check in the specification sheet for the scale.  
 For example, when using a serial communication type external scale having the resolution of 1 nm, the maximum speed is 4 m/s.  
 Even with the full-closed control, the overspeed protection occurs if the motor axis rotation speed exceeds the maximum speed.

\*4. Others, please contact the Company for supporting external scales.

## 4-5-2 Setting of external scale division ratio

This section describes the setting of division ratio with encoder resolution and external scale resolution.

■ Relevant parameters

Class	No.	Attribute *1)	Title	Range	Unit	Function
3	24	R	Numerator of external scale division	0 – 2 <sup>23</sup>	—	Sets the numerator of external scale division setting. When the set value = 0, the operation is performed with the encoder resolution used as the division numerator.
3	25	R	Denominator of external Scale division	1 – 2 <sup>23</sup>	—	Sets the denominator of external scale division setting.

\*1) For parameter attribute, refer to Section 9-1.

- Check the encoder pulse count per one motor rotation and the external scale pulse count per one motor rotation, then set the numerator of external scale division (Pr3.24) and denominator of external scale division (Pr3.25) so that the equation below becomes true.

Example) With 10mm ball screw pitch, 0.1µm/pulse scale, 23-bit (8,388,608pulse/r) encoder resolution

$$\frac{\text{Pr3.24 } \boxed{8388608}}{\text{Pr3.25 } \boxed{100000}} = \frac{\text{Encoder pulse count per one motor rotation [pulse]}}{\text{External scale pulse count per one motor rotation [pulse]}}$$

- If the ratio is incorrect, the difference increases between the position calculated from encoder pulse and the position calculated from external scale pulse, and the hybrid deviation excess error protection occurs especially when the movement distance is long.
- When Pr3.24 is set to 0, the encoder resolution is automatically set as the numerator.

#### 4-5-3 Setting of hybrid deviation excess

The difference between the motor (encoder) position and load (external scale) position is detected, and when the difference exceeds Pr3.28 "Hybrid deviation excess setup", the hybrid deviation excess error protection is activated. The hybrid deviation excess occurs mainly when there is an external scale error, external scale connection fault, and motor-load connection looseness.

##### ■ Relevant parameters

Class	No.	Attribute *1)	Title	Range	Unit	Function
3	28	C	Hybrid deviation excess setup	1-2 <sup>27</sup>	Command unit	Sets the allowance (hybrid deviation) between the motor (encoder) position and load (external scale) position on a command basis.
3	29	C	Hybrid deviation clear setup	0-100	Rotation	Each time the motor rotates for the amount of this set value, the hybrid deviation is cleared to zero. When the set value is zero, the hybrid deviation is not cleared.

\*1) For parameter attribute, refer to Section 9-1.

##### • Regarding hybrid deviation clear specification

Each time the motor rotates for the amount set with Pr3.29 "Hybrid deviation clear setup", the hybrid deviation is cleared to zero. By this function, operation becomes possible even with uses with which an accumulation of hybrid deviation occurs due to slippage or other reasons.

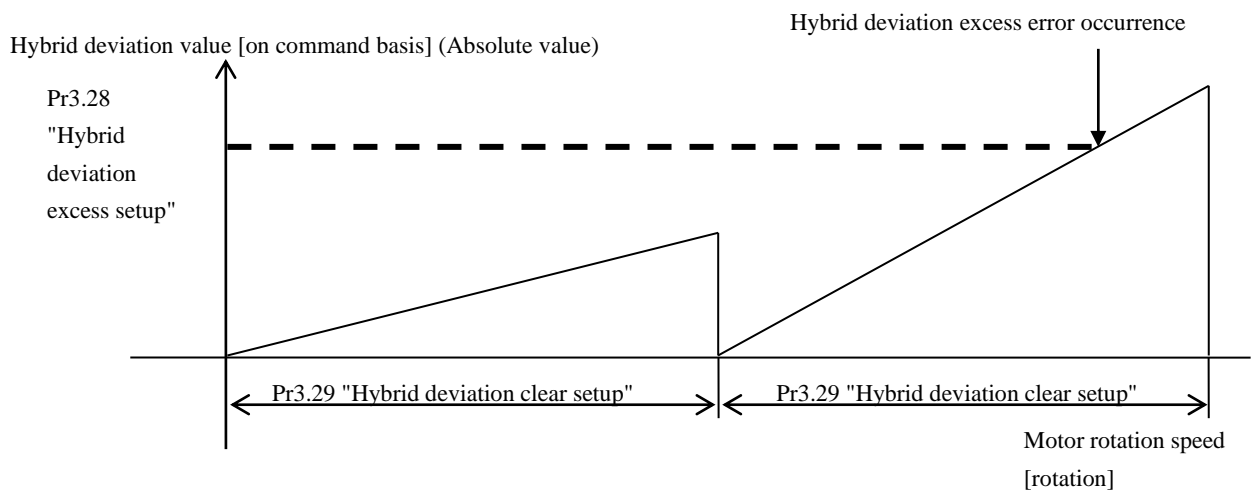

Note) The rotation speed for hybrid deviation clear setting is detected by the use of encoder feedback pulse.

When using the hybrid deviation clear, make sure to set the Pr3.29 "Hybrid deviation clear setup" to an appropriate value. If set to a significantly smaller value compared with the set value of Pr3.28 "Hybrid deviation excess setup", this function may not work correctly as a protection against an abnormal operation caused by improper connection of external scale or others.

When using, pay close attention to safety, and install a limit sensor or implement other means.

Other than the above, hybrid deviation is cleared when the following position information is initialized:

- When turning on the power of the absolute system
- When establishing communication (when changing ESM state from Init to PreOP)
- When completing returning to home
- When completing the execution of the functions below by the setup support software (PANATERM)
  - Test run function, Z phase search function, frequency response analyzing function (FFT), fit gain function, pin assignment setting, multi-turn clearing of the absolute encoder
- When Err27.4 (Command error protection) occurs

## 4-5-4 Full-closed control function (Rotary scale)

It cannot be used in [A6BE].

This section describes the full-closed control function using a rotary scale.

## 1) Applicable Range

This function operates under the following conditions:

Conditions under which full-closed control using a rotary scale operates	
Control mode	<ul style="list-style-type: none"> <li>• Cyclic position control (csp) only</li> <li>• Operation in case it is switched to any other control mode cannot be guaranteed.</li> </ul>
Other	<ul style="list-style-type: none"> <li>• Software version should be function extended edition 3 or higher.</li> <li>• It should be in a servo-on condition.</li> <li>• Factors other than the control parameters such as torque limit should be properly set, with no hindrance to normal rotation of the motor.</li> <li>• The electronic gear ratio should be 1:1.</li> <li>• The encoder setting should be absolute mode (Pr0.15=0).</li> <li>• The rotary scale should support the Panasonic serial communication absolute rotary format, and the only types supported are 23bit (8,388,608 resolution), 27bit (134,217,728 resolution) and 29bit (536,870,912 resolution).</li> <li>• The type of absolute encoder should be 23bit (8,388,608 resolution) only.</li> <li>• For others, see Section 4-5.</li> </ul>

## ■ Structure of system

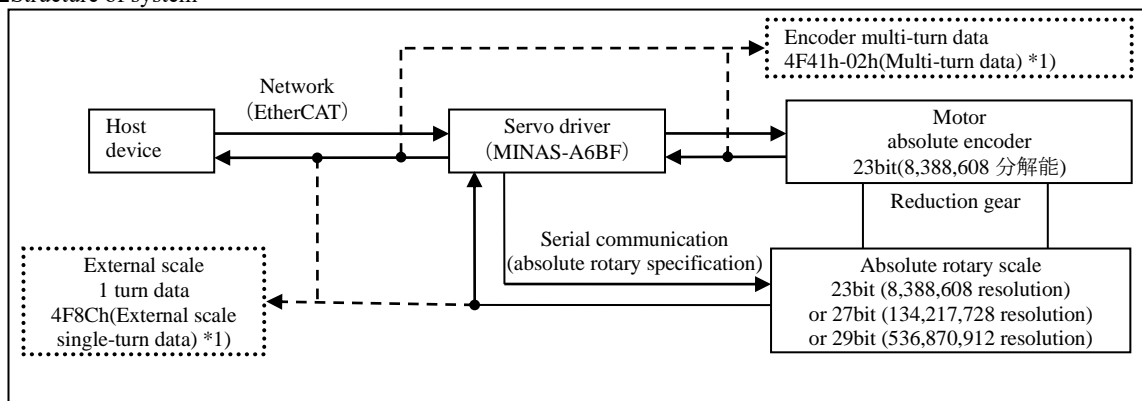

\*1) Refer to EtherCAT communication specification edition for EtherCAT object.

■ Calculation of machine coordinates

The servo driver side does not calculate the machine coordinates with the use of encoder multi-turn data.

It is necessary to obtain “encoder multi-turn data” and “external scale single-turn data” through EtherCAT communication and calculate the machine coordinates on the host device side.

<Example>

Calculate the machine coordinates based on the calculation method below:

This example is explained with the presumption that the power supply is started at the bold broken line in the figure below with the external scale resolution of 29bit (536,870,912 resolution) and reduction ratio 120.

(1) Calculation of multi-turn data on machine

$$\begin{aligned} \text{Multi-turn data on machine} &= \text{encoder multi-turn data} / \text{reduction ratio} \\ &= 300 / 120 = 2 \text{ (figures below decimal point omitted)} \end{aligned}$$

(2) Calculation of machine coordinates

$$\begin{aligned} \text{Machine coordinates} &= \text{external scale resolution} \times \text{multi-turn data on machine} \\ &\quad + \text{external scale single-turn data} \\ &= 536,870,912 \times 2 + 4,194,304 = 1,077,936,128 \end{aligned}$$

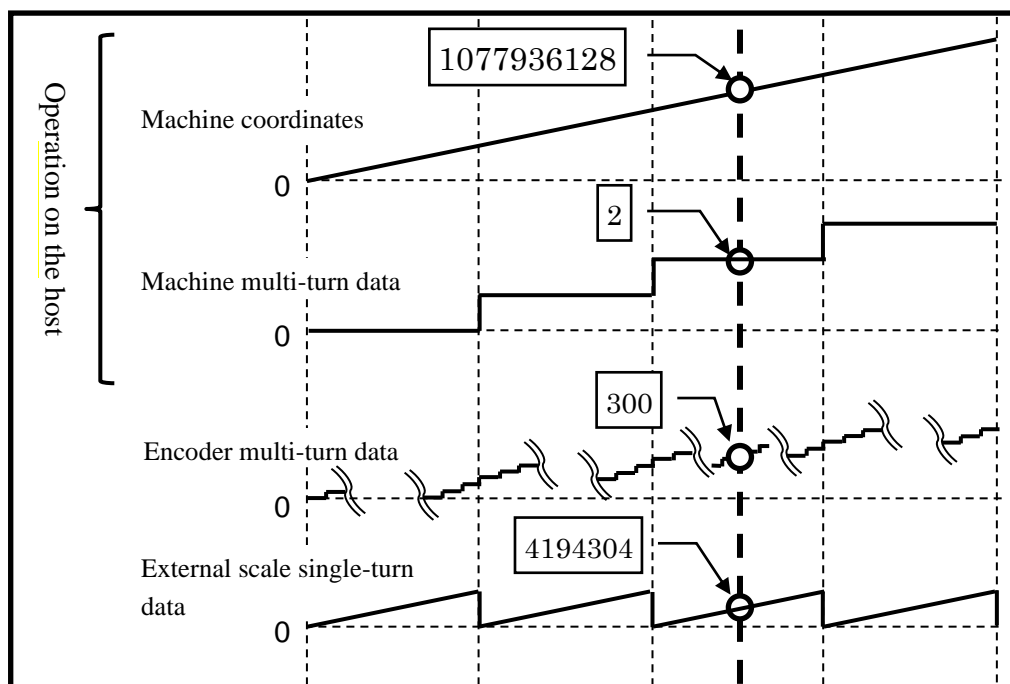

### ■ Servo driver coordinates

Servo driver coordinates indicate the actual position (position which can be obtained with 6064h (Position actual value)).

To set up the command position from the host, input a value according to the servo driver coordinates.

The range which servo driver coordinate data can cover is the range of signed 32bit (-2,147,483,648 to 2,147,483,648). The value is subjected to wraparound if it exceeds the maximum value.

### Caution

- Since the servo driver coordinates are initialized based on “external scale single-turn data” at power supply startup, the servo driver coordinates may not match the machine coordinates, depending on the machine coordinates at power startup.
- In the example of position data related to control shown in the figure below, the servo driver coordinates are set as (A)’ when the power is started within the machine coordinate range (A), and (B)’ if the power is started within range (B). If position control is executed using the target position based on the machine coordinates as the command position while the machine coordinates do not match the servo driver coordinates, the system will not operate properly. In this case, set the value taking into consideration the amount of shift (offset) between the machine coordinates and servo driver coordinates as the command position.

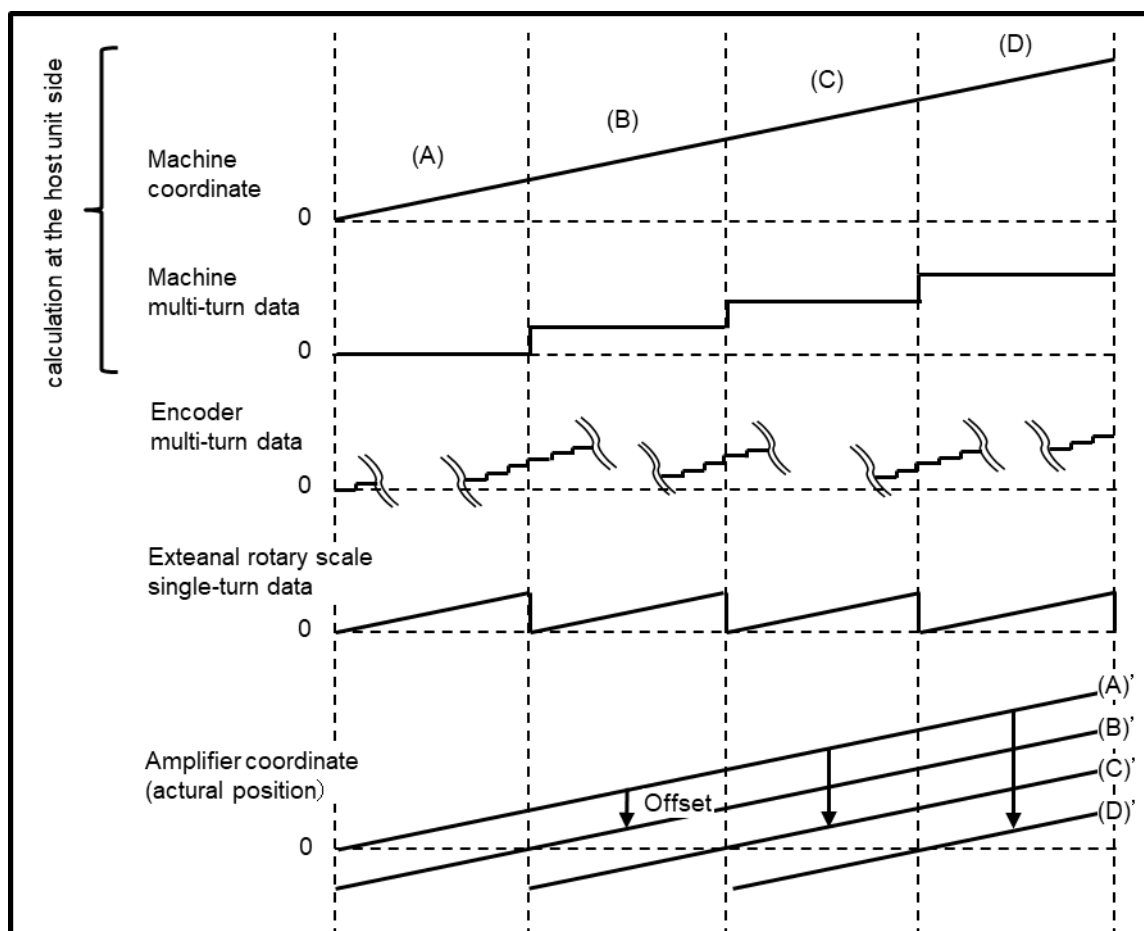

## ■ Relevant parameters

Class	No.	Attribute*1)	Title	Range	Unit	Function
0	01	R	Control mode setting	0~6	—	Selects the servo driver control mode. 0 : Semi-closed control (position/velocity/torque control switching possible) 1~5 : For manufacturer's use (setting prohibited) 6 : Full-closed control (position control only)
0	15	C	Absolute encoder setting	0~3	—	Sets up how absolute encoder is used. *2) 0 : Used under absolute system (absolute mode). 1 : Used under incremental system (incremental mode). (Detection of the protective functions below will be disabled: Err40.0 "Absolute system down error protection" Err41.0 "Absolute counter over error protection" Err42.0 "Absolute over-speed error protection" Err45.0 "Absolute multi-turn counter error protection") 2 : Used under absolute system (absolute mode), but multi-turn counter over is neglected. 3 : Used under absolute system (absolute mode), but multi-turn counter is not used. (single-turn absolute mode) 4 : Used under absolute system (absolute mode), but the upper limit value for multi-turn counter can be set to an arbitrary value. Multi-turn counter over is also neglected. (infinite turn absolute mode) (Note) Set this to 0 for full-closed control function (Rotary scale).
3	23	R	External scale type selection	0~6	—	Selects the type of external scale. Be sure to set it to match the type of external scale which is being used. 0 : AB phase output type 1 : Serial communication type (incremental specification) 2 : Serial communication type (absolute specification) 3~5 : For manufacturer's use 6 : Serial communication type (absolute rotary specification) Err50.0 "External scale connection error protection" occurs if setting value 1, 2 or 6 is set while an AB phase output type is selected, and Err55.0-55.2 "A-phase or B-phase or Z-phase connection error protection" occurs if setting value 0 is set while a serial communication type is connected. Err.93.3 "External scale connection error protection" occurs if setting value 1 is set while a serial communication type scale with absolute specification is connected, if setting value 2 or 6 is set while a serial communication type scale with incremental specification is connected, or if setting value 3, 4 or 5 is set regardless of the type of scale connected.
3	24	R	External scale division numerator	0~2 <sup>23</sup>	—	Sets up the numerator for external scale division setting. The system operates with the encoder resolution used as the division numerator when setting value = 0.
3	25	R	External scale division denominator	1~2 <sup>23</sup>	—	Sets up the denominator for external scale division setting.
3	26	R	External scale reversal of direction	0~3	—	Sets up the reversal of direction for external scale feedback counter. 0 : No reversal 1 : Reversed 2~3 : For manufacturer's use *2)
6	97	B	Function extended setup 3	-2147483648 ~ 2147483647	-	bit3 : Selection of external scale single-turn data monitor *2) 0 : No reversal (data obtained by scale), 1 : Reversed * This bit is valid only for full-closed control (Rotary scale).
6	98	R	Function extended setup 4	-2147483648 ~ 2147483647	-	Bit10 : Switching of the specification for external scale absolute position on PANATERM monitor screen. *2) 0 : External scale absolute position 1 : External scale single-turn data

(To be continued)



## ■Relevant parameters

Class	No.	At-trib-ute*1)	Title	Range	Unit	Function
9	01	R	External scale resolution	0~ 536870912	pulse	Sets up the resolution for the absolute rotary scale connected under full-closed control function (Rotary scale). Only absolute rotary scales of 23bit (8,388,608 resolution), 27bit (134,217,728 resolution) and 29bit (536,870,912 resolution) are supported. *2)

\*1) For parameter attribute, refer to Section 9-1.

\*2) It is not supported in function extended edition 2 and earlier versions.

■How to use

Set up the following parameters properly, write them in EEPROM, then restart the power supply.

- ① Pr0.01 “Control mode selection”  
Set to setting value 6 (full-closed control).
- ② Pr0.15 “Absolute encoder setup”  
Set to setting value 0 (used as absolute).
- ③ Pr3.23 “External scale type selection”  
Set to setting value 6 (serial communication type (absolute rotary specification)).
- ④ Pr9.01 “External scale resolution”  
Set the resolution value for the external scale resolution to be used.
- ⑤ Pr3.24 “External scale division numerator,” Pr3.25 “External scale division denominator”  
Sets up the encoder resolution and the division ratio for external scale resolution.  
<Example 1>  
When absolute encoder is 23bit, and absolute rotary scale is 23bit,  
Pr3.24 “External scale division numerator” = 1, Pr3.25 “External scale division denominator” = 1  
  
<Example 2>  
When absolute encoder is 23bit, and absolute rotary scale is 27bit,  
Pr3.24 “External scale division numerator” = 1, Pr3.25 “External scale division denominator” = 16  
For details, refer to Section 4-5-2.
- ⑥ Pr3.26 “Reversal of direction of external scale”  
If the scale position data counts up when the motor shaft is turned in CCW direction, set 0 as the setting value.  
Set 1 as the setting value if it cannot be installed in upward direction due to the external scale installation condition and so forth.
- ⑦ Pr6.97 bit3 “External scale single-turn data monitor selection”  
It can be used to change the monitor specifications of external scale single-turn data.

Set up the parameters properly with reference to the figure below:

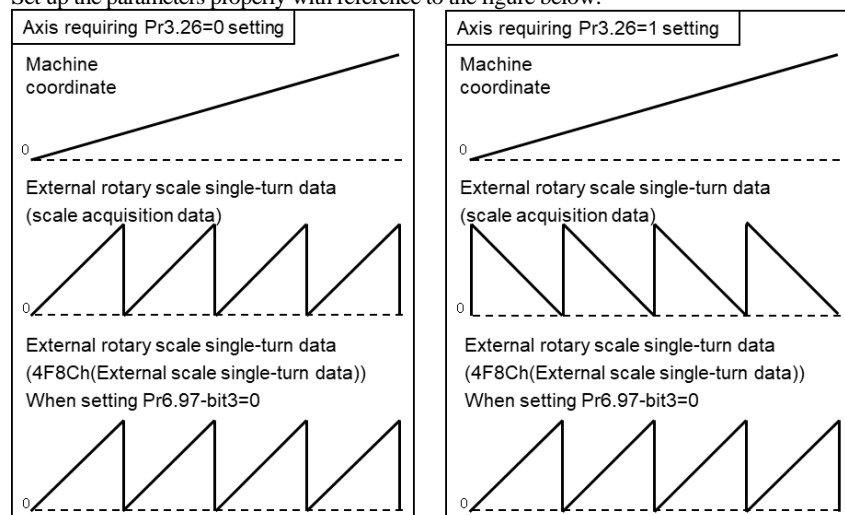

- ⑧ 4F8Ch (External scale single-turn data)  
It can obtain the external scale single-turn data, and be used for calculation of machine coordinates by combining the value with encoder multi-turn data.  
For details, refer to Technical Reference EtherCAT Communication Specification (SX-DSV03242).

■Caution

- (1) To calculate the machine coordinates, check that the external scale single-turn data is at a position near the median value. If calculation is executed when the external scale single-turn data is near the 0 position, it may be impossible to calculate the correct machine coordinates as inappropriate encoder multi-turn data is obtained due to machine torsion and so forth.
- (2) When Pr3.26=1 is set, the sign of the servo driver coordinates is reversed. Please note that the sign for encoder multi-turn data or the sign for external scale single-turn data are not reversed.
- (3) Please note that the maximum value for machine multi-turn is  $65535 / \text{reduction ratio}$  since the maximum value for encoder multi-turn data is  $2^{16}-1=65535$ .
- (4) Wraparound is executed for external scale single-turn data when passing through the maximum value or the 0 position. Therefore, to calculate the amount of movement on the machine coordinates by the difference between the current value and the previous value for external scale single-turn data, add (or subtract) the external scale resolution and calculate the correct amount of movement when wraparound is executed.  
For example, when wraparound is executed in count-up direction for an external scale with resolution 29bit (536,870,912 resolution) as shown in the figure below, and when the previous value was 536,870,911 [pulse], and the current value 100,000 [pulse], the amount of movement is calculated as 100,001 [pulse].

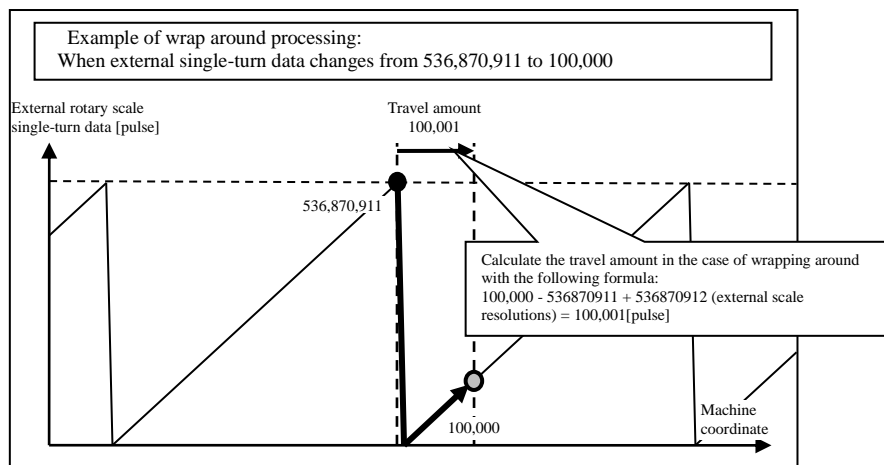

- (5) Use this function with electronic gear ratio 1:1.  
1 command pulse (1 command unit) when the electronic gear ratio is 1:1 corresponds to 1 pulse for the external scale.  
In full-closed control, velocity control is executed on encoder feedback, and position control on external scale feedback.  
(For details, refer to EtherCAT Communication Specification (SX-DSV03242), Section 6-9-4.)
- (6) Set Pr3.28 "Hybrid deviation excess setup" and Pr3.29 "Hybrid deviation clear setup" to appropriate values. When the hybrid deviation excess range is set excessively wide, error detection will be delayed and the function will lose its effect. In addition, if set excessively narrow, the torsion between motor and equipment in normal operation may be detected as abnormal. For details, refer to Section 4-5-3.
- (7) For external scales,  $1/40 \leq \text{external scale ratio} \leq 160$  is recommended.  
Control in the unit of 1 pulse of external scale may become impossible if the external scale ratio is set to a value smaller than the 50/position loop gain (Hz).  
The operation noise may become excessive if the external scale ratio is set too large.
- (8) When a wrong external scale division ratio is set, even if the external scale and motor position agree with each other, Err25.0 "Hybrid deviation excess error protection" may occur especially when the stroke distance is long. In this case, use with the external scale division ratio set to a value that is as close as possible, and the hybrid deviation excess range expanded.
- (9) Be sure to connect an absolute encoder when using full-closed control (Rotary scale).

## 4-6 Setting regenerative resistor

Cannot be used with [V frame].

The table describes setup of regenerative resistor.

For details of regenerative resistor specification, refer to Standard specifications.

## ■ Relevant parameters

Class	No.	Attribute *1)	Title	Range	Unit	Function
0	16	C	External Regenerative resistor setup	0-3	—	<p>With this parameter, you can select either to use the built-in regenerative resistor of the driver, or to separate this built-in regenerative resistor and externally install the regenerative resistor. *2)</p> <p>0: Use the built-in resistor and activate regenerative over-load protection.</p> <p>1: Use the external resistor and activate regenerative over-load protection.</p> <p>2: Use the external resistor but do not activate regenerative over-load protection.</p> <p>3: Do not use regenerative resistor. (Do not use over-load protection.)</p>
0	17	C	Selection of load factor of external regenerative resistor	0-4	—	<p>When selecting the external regenerative resistor (Pr 0.16 = 1, 2), select the computing method of load factor of regenerative resistor. *2)</p> <p>0: Regenerative load factor is 100% when duty factor of external regenerative resistor is 10%. (Compatible with A4N series)</p> <p>1-4: For manufacturer's use (do not setup)</p>

\*1) For parameter attribute, refer to Section 9-1.

\*2) Please do not change the shipment value setting with V frame.

## 4-7 Absolute setup

## 4-7-1 Absolute encoder

By setting Pr0.15 "Absolute encoder setup" to a value other than "1" (default), you can compose an absolute system that does not require homing operation after power-on.

For details of the single-turn absolute function, refer to section 6-6.

For details of the continuous rotating absolute encoder function, refer to section 6-7.

## ■ Relevant parameters

Class	No.	Attribute *1)	Title	Range	Unit	Function
0	15	C	Absolute encoder setup	0-4	—	<p>Sets the method of using the absolute encoder. *2)</p> <p>0: Use under absolute system (Absolute mode).*3)</p> <p>1: Use under incremental system (Incremental mode). (Detection of the following protection functions is disabled. Err40.0 "Absolute system down error protection" Err41.0 "Absolute counter over error protection" Err42.0 "Absolute over-speed error protection" Err45.0 "Absolute multi-turn counter error protection")</p> <p>2: Use under absolute system (Absolute mode) but multi-rotation counter overflow is ignored</p> <p>3: Use under absolute system, however not use the multi-turn counter (single-turn absolute mode)*3)</p> <p>4: Use under absolute system (Absolute mode) but the upper limit value of the multi-rotation counter can be set to any value. Multi-rotation counter overflow is also ignored. (continuous rotation absolute mode)</p> <p>(Note) Set this to 0 for full-closed control function (Rotary scale).</p>

\*1) For parameter attribute, refer to Section 9-1.

\*2) During full-closed controlling, treated as an incremental encoder (setting value = 1) for internal control.

\*3) Do not refer to the read value of multi-turn data in increment mode and single-turn absolute mode.

Refer to the table below as to whether connection of the battery for absolute data according to Pr0.15 "Absolute encoder setup" is required or not.

Absolute encoder type	Pr0.15 "Absolute encoder setup"	
	0,2,4	1,3
Battery-powered	Required	Not required
Battery-less	Not required	

## 4-7-1-1 Structure of absolute system

Absolute system configuration using EtherCAT communication interface

(Example: with servo driver single-axis connection)

In the EtherCAT communication response (driver → host controller), the absolute data is transferred to the host controller as the current position data.

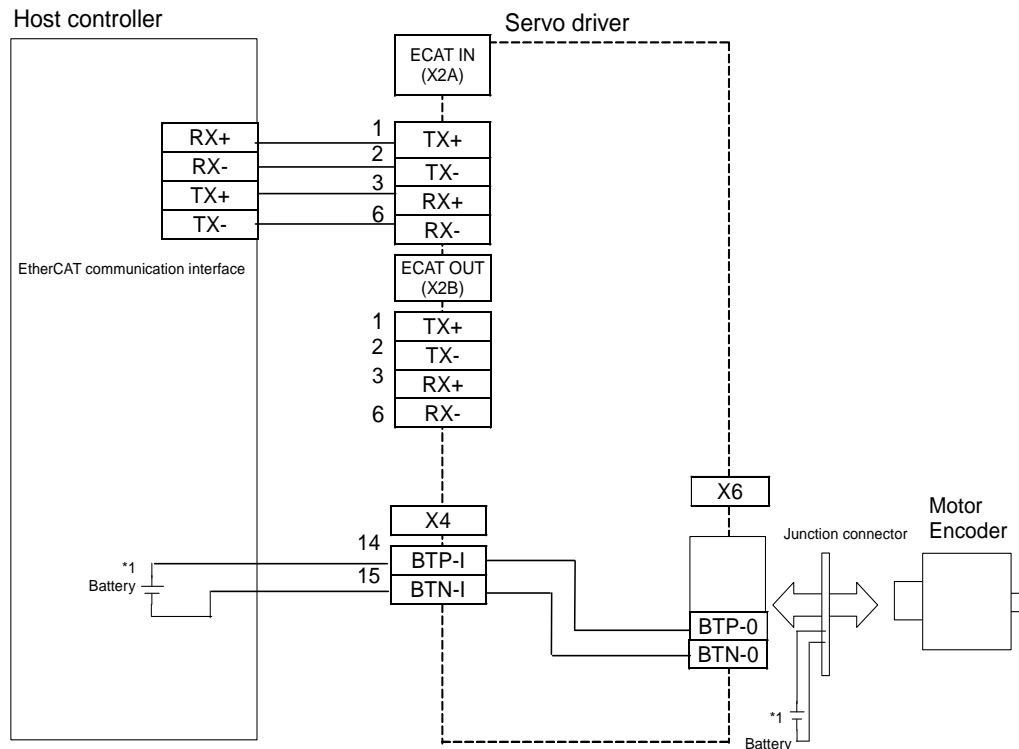

- \*1. Connect to either X4 or the junction connector between X6 and the encoder, when you connect the battery.  
Do not connect to both.

Note: During replacing the battery, the control power input must be held ON. If not so, the absolute data will be lost.

## 4-7-1-2 Installing battery for absolute data

Refer to Standard specifications.

## 4-7-1-3 Clearing of absolute data

Multi-turn data of the battery-powered absolute encoder is retained by the battery for absolute data, and multi-turn data of the battery-less absolute encoder is retained without using a battery.

Therefore, when you start up the machine for the first time, it is required to make the multi-turn data to 0 by encoder clearing at the home position after installing the battery.

Clearing operation of absolute encoder is made through USB communication (PANATERM) or EtherCAT communication. After clearing the absolute data, turn OFF and ON the control power.

For information about clearing via USB communication (PANATERM), refer to the operating manual of PANATERM.

For information about clearing via EtherCAT communication, refer to the section 6-9-4 “4” in the Technical Reference EtherCAT Communication Specification (SX-DSV03242).

#### 4-7-1-4 Battery refresh for the battery-powered absolute encoder

If batteries (lithium-thionyl chloride battery) are not discharged for a long time, including long storage, battery alarm may occur due to the phenomenon of transient voltage drop at the next discharge.

In order to prevent this, you can perform battery discharge treatment (refreshment).

Battery refreshment is performed by USB communication (setup support software).

Note: When battery refreshment is executed, battery warning may occur.

In that case, clear the battery warning.

Note: Do not perform battery refresh when using the battery-less absolute encoder.

## 4-7-2 External scale

Under full-closed control, an absolute system that does not require return to origin action after power-up, can be configured

## 4-7-2-1 External scale absolute system configuration

Absolute system configuration using EtherCAT communication interface

(Example: with servo driver single-axis connection)

In the EtherCAT communication response (driver -> host controller), the absolute data is transferred to the host controller as the current position data.

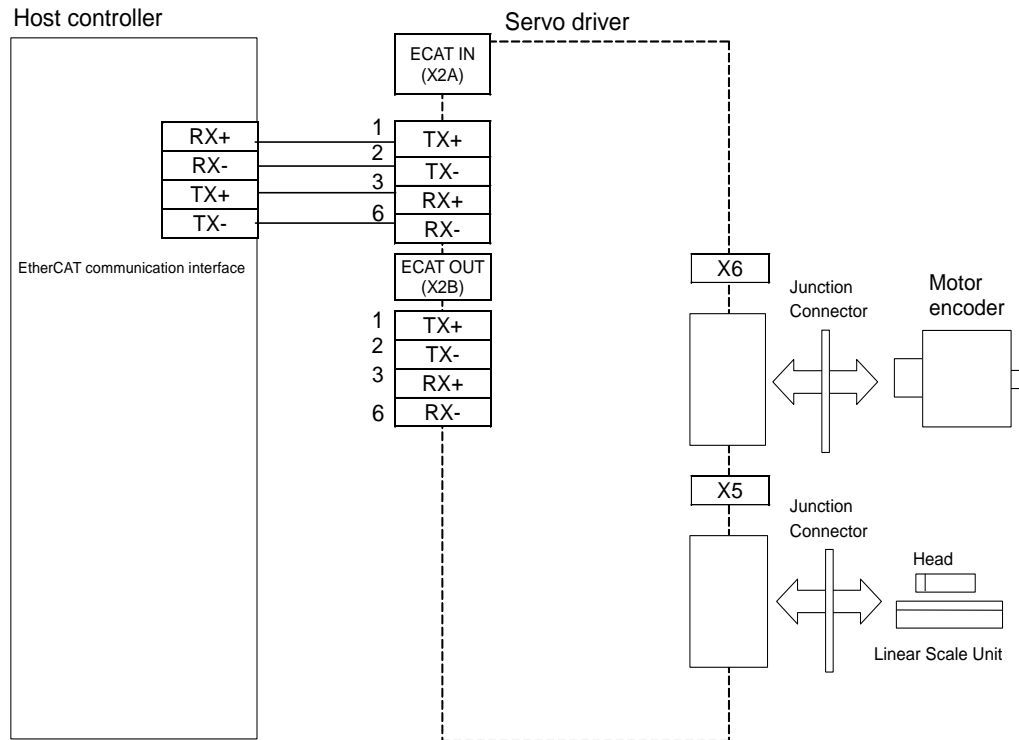



## 4-8 External scale position information monitor function under semi-closed control

[A6BE]: This function cannot be used.

External scale position information can also be monitored by EtherCAT communications under semi-closed control, and full-closed control can be conducted from the host controller.

This function can be used in all semi-closed control mode (position, velocity, and torque).

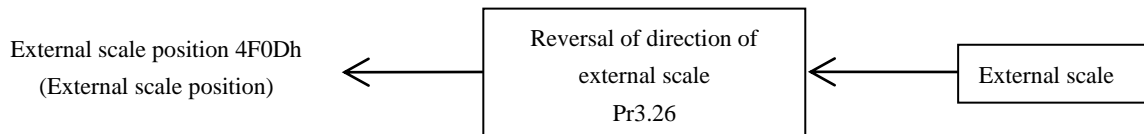

■ Relevant parameters

Class	No.	Attribute *1)	Title	Range	Unit	Function
3	23	R	External scale Selection *2)	0-6	—	Selects the type of external scale. 0: A, B phase output type 1: Serial communication type (Incremental specification) 2: Serial communication type (Absolute specification) 3-5: For manufacturer's use 6: Serial communication type (Absolute specification (Rotary scale))
3	26	R	Reversal of direction of external scale*2)	0-3	—	Sets the direction inversion of the external scale feedback counter. 0: Non-inversion 1: Inversion 2: For manufacturer's use *3) 3: For manufacturer's use *3)
3	27	R	External scale Z phase disconnection detection disable	0-1	—	Validate/Invalidate Z-phase disconnection detection when using AB phase output type external scale. 0: Valid, 1: Invalid
7	22	R	Communication function extended setup 1	-32768 -32767	—	[bit4] External scale position information monitoring function under semi-closed control setting: 0 : Invalid 1 : Valid * Under full-closed control, external scale position information can be monitored regardless of the setting of this bit.

\*1) For parameter attribute, refer to Section 9-1.

\*2) For external scale selection and reversal of direction of external scale, refer to section 4-5-1.

\*3) It is not supported in versions corresponding to function extended edition 2 or earlier.

- When this function is effective, the following functions become effective by not only full-close but semi-close. Since the alarm function of the external scale also becomes effective, be careful.

- Read-out function of the external scale position 4F0Dh (External scale position) with the EtherCAT communication

- Read-out function of 4D10h-01h (External scale vendor ID) and 4D10h-02h (External scale model ID)

- Read-out function of other relevant objects (4F48h, 4F49h, 4F83h, 4F84h, 4F87h, 4F88h and 4F89h)

- Alarm and warning detection function of disconnection, the abnormalities in communication

and the abnormalities in status (Err93.3, Err50.0-2, Err51.0-5, Err55.0-2, WngA8h, WngA9h) of the external scale.

- When this function is effective, the following contents are not reflected in the external scale position 4F0Dh (External scale position) with the EtherCAT communication.

- 607Eh (Polarity)

- 608Fh (Position encoder resolution), 6091h (Gear ratio), 6092h (Feed constant)

- 607Ch (Home offset)

\* Reversal of direction of external scale (Pr3.26) is reflected.

- It cannot be used in 0.250ms and 0.125ms of communication cycles.

When this function is enabled in 0.250ms and 0.125ms of communication cycles, Err91.1 "Command error protection" occurs.

- Please set suitable value to Pr3.23 "External scale type selection" in accordance with the specification of the external scale which connects.

In the case where this is not suitable, Err93.3 "external scale connection error protection" occurs.

- In the following cases, 4F0Dh (External scale position) is initialized.

- At the time of the control power supply ON

\* It does not initialize at return to origin.

## 5. Gain tuning/vibration suppressing function

### 5-1 Automatic adjusting function

The figure below shows outline of automatic adjusting function of MINAS-A6B series.

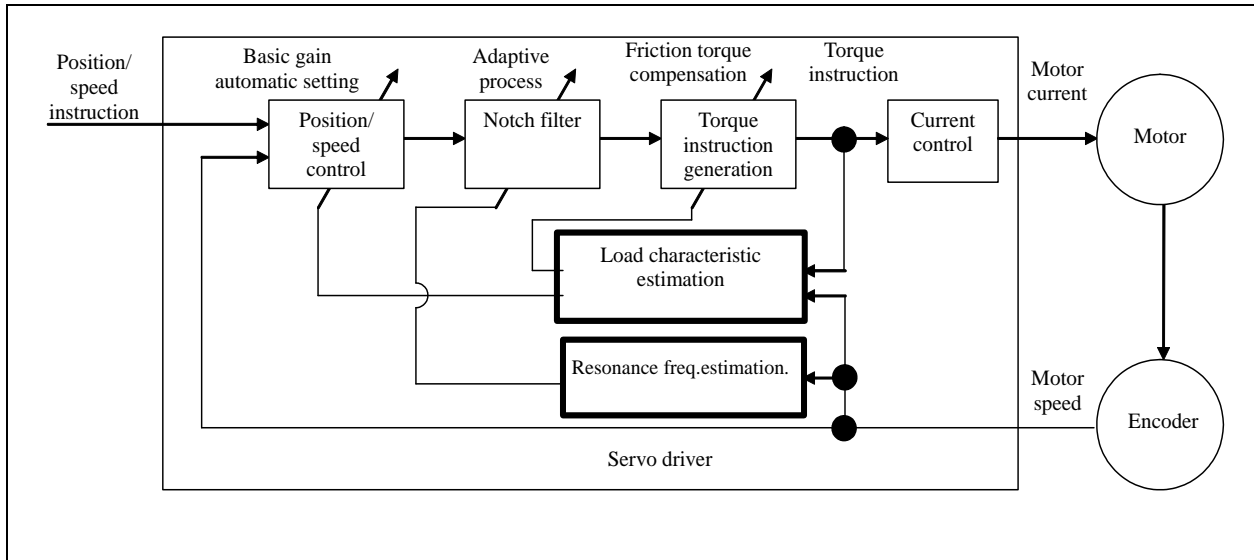

- 1) Real-time auto tuning  
Estimates the load characteristics based on the motor velocity and torque command, and automatically sets up the basic gain related to position and velocity control, based on estimated inertia. Also estimates the friction torque at the same time and adds the estimated value to the torque command to shorten positioning settling time.
- 2) Adaptive filter  
Estimates the resonance frequency based on the motor velocity and removes the frequency components from torque command to prevent resonant oscillation.

### 5-1-1 Real-Time Auto Tuning

The system estimates the load characteristics in real time, and automatically performs basic gain setting and friction compensation by referring to stiffness parameter.

For the 2 degrees of freedom control mode, refer to section 5-1-3/5-1-4.

#### 1) Applicable Range

This function operates under the following conditions.

	Real-time auto-tuning condition
Control Mode	Specific real-time auto-tuning mode is selected according to the currently active control mode. For details, refer to the description of Pr 0.02 Real time auto-tuning setup.
Others	<ul style="list-style-type: none"> <li>• Should be in servo-on condition</li> <li>• Parameters except for controls such as torque limit setup, are correctly set, assuring that the motor can run smoothly.</li> </ul>

#### 2) Caution

- After the power is turned on, estimate value following may become quicker regardless of Pr6.31 “Real-time auto tuning estimation speed” until operation data effective for the estimation of load characteristics is sufficiently accumulated.
- When real-time auto-gain tuning is effective, an estimate value may become abnormal due to disturbance. If you want to obtain stable operation from when the power is turned on, it is recommended to disable the real-time auto-gain tuning.

Real-time auto-gain tuning may not be executed properly under the conditions described below. If not properly executed, change the loading condition or operating pattern, or manually set up the related parameters by referring to the manual adjustment function description.

	Conditions which obstruct real-time auto-gain tuning action
Load inertia	<ul style="list-style-type: none"> <li>• The load inertia is too small or large compared to the rotor inertia. (less than 3 times or more than 20 times).</li> <li>• The load inertia changes too quickly.</li> <li>• The machine stiffness is extremely low.</li> <li>• Nonlinear characteristics such as backlash exist.</li> </ul>
Action pattern	<ul style="list-style-type: none"> <li>• The motor is running continuously at low speed of 100 [r/min] or lower.</li> <li>• Acceleration/deceleration is slow (2,000 [r/min] per 1 [s] or low).</li> <li>• When the speed condition of 100 [r/min] or more and acceleration/deceleration condition of 2,000 [r/min] per 1 [s] are not maintained for 50 [ms].</li> <li>• Acceleration/deceleration torque is smaller than unbalanced weighted/viscous friction torque.</li> </ul>

## 3) Real-time auto tuning control parameters

Use the following parameters to set up the operation of real-time auto tuning.

Class	No.	Attribute *1)	Title	Range	Unit	Function																								
0	02	B	Real-time auto-gain tuning setup	0-6	—	<p>You can set up the action mode of the real-time auto-gain tuning.</p> <table border="1"> <thead> <tr> <th>Setup value</th> <th>Mode</th> <th>Description</th> </tr> </thead> <tbody> <tr> <td>0</td> <td>Invalid</td> <td>Real-time auto-gain tuning function is disabled.</td> </tr> <tr> <td>1</td> <td>Standard</td> <td>Stability-sensitive mode. Do not use unbalanced load, friction compensation or gain switching.</td> </tr> <tr> <td>2</td> <td>Positioning *1</td> <td>Position-sensitive mode. Use this mode for machine using horizontal axis without offset load or ball screw driven machine with small friction.</td> </tr> <tr> <td>3</td> <td>Vertical axis *2</td> <td>This mode adds the following features to those of positioning mode: compensates for offset load in vertical axis and minimizes positioning settling time variations.</td> </tr> <tr> <td>4</td> <td>Friction compensation *3</td> <td>This mode adds the following features to those of vertical axis mode: shortens positioning settling time on large friction system such as belt driven axis.</td> </tr> <tr> <td>5</td> <td>Load characteristic measurement</td> <td>This mode only estimates the load characteristics without changing the basic gain setting or friction compensation setting. Use these features in conjunction with the setup support software.</td> </tr> <tr> <td>6</td> <td>Customize *4</td> <td>By precisely setting combination of real-time auto tuning functions through Pr 6.32 Real time auto tuning custom setup, customization to fit the application can be made.</td> </tr> </tbody> </table> <p>*1 Velocity and torque controls are the same as in the standard mode.  *2 Torque control is the same as in the standard mode.  *3 Velocity control is the same as in the vertical axis mode. Torque control is the same as in the standard mode.  *4 Certain function(s) is not available in a specific control mode. Refer to description in Pr 6.32.</p>	Setup value	Mode	Description	0	Invalid	Real-time auto-gain tuning function is disabled.	1	Standard	Stability-sensitive mode. Do not use unbalanced load, friction compensation or gain switching.	2	Positioning *1	Position-sensitive mode. Use this mode for machine using horizontal axis without offset load or ball screw driven machine with small friction.	3	Vertical axis *2	This mode adds the following features to those of positioning mode: compensates for offset load in vertical axis and minimizes positioning settling time variations.	4	Friction compensation *3	This mode adds the following features to those of vertical axis mode: shortens positioning settling time on large friction system such as belt driven axis.	5	Load characteristic measurement	This mode only estimates the load characteristics without changing the basic gain setting or friction compensation setting. Use these features in conjunction with the setup support software.	6	Customize *4	By precisely setting combination of real-time auto tuning functions through Pr 6.32 Real time auto tuning custom setup, customization to fit the application can be made.
Setup value	Mode	Description																												
0	Invalid	Real-time auto-gain tuning function is disabled.																												
1	Standard	Stability-sensitive mode. Do not use unbalanced load, friction compensation or gain switching.																												
2	Positioning *1	Position-sensitive mode. Use this mode for machine using horizontal axis without offset load or ball screw driven machine with small friction.																												
3	Vertical axis *2	This mode adds the following features to those of positioning mode: compensates for offset load in vertical axis and minimizes positioning settling time variations.																												
4	Friction compensation *3	This mode adds the following features to those of vertical axis mode: shortens positioning settling time on large friction system such as belt driven axis.																												
5	Load characteristic measurement	This mode only estimates the load characteristics without changing the basic gain setting or friction compensation setting. Use these features in conjunction with the setup support software.																												
6	Customize *4	By precisely setting combination of real-time auto tuning functions through Pr 6.32 Real time auto tuning custom setup, customization to fit the application can be made.																												
0	03	B	Setup of machine stiffness at real-time auto-gain tuning	0-31	—	You can set up the response while the real-time auto-gain tuning is valid. Higher the setup value, higher the velocity response and servo stiffness will be obtained. However, when increasing the value, check the resulting operation to avoid oscillation or vibration.																								
6	10	B	Function expansion setup	-32768-32767	—	The automatic adjustment of load change inhibit function is enabled with bit14=1.																								

(To be continued)

Class	No.	Attribute *1)	Title	Range	Unit	Function															
6	31	B	Real time auto tuning estimation speed	0-3	—	<p>Set up the load characteristics estimation speed with the real time auto tuning being valid. A higher setup value assures faster response to a change in load characteristics but increases variations in disturbance estimation. Result of estimation is saved to EEPROM every 30 minutes.</p> <table border="1"> <thead> <tr> <th>Setup value</th> <th>Mode</th> <th>Description</th> </tr> </thead> <tbody> <tr> <td>0</td> <td>No change</td> <td>Stop estimation of load characteristics.</td> </tr> <tr> <td>1</td> <td>Almost constant</td> <td>Response to changes in load characteristics in every minute.</td> </tr> <tr> <td>2</td> <td>Slower change</td> <td>Response to changes in load characteristics in every second.</td> </tr> <tr> <td>3 *</td> <td>Faster change</td> <td>Obtain best suitable estimation in response to changes in load characteristics.</td> </tr> </tbody> </table> <p>* If the automatic oscillation detection is enabled by the support software, the setup value 3 is used.</p>	Setup value	Mode	Description	0	No change	Stop estimation of load characteristics.	1	Almost constant	Response to changes in load characteristics in every minute.	2	Slower change	Response to changes in load characteristics in every second.	3 *	Faster change	Obtain best suitable estimation in response to changes in load characteristics.
Setup value	Mode	Description																			
0	No change	Stop estimation of load characteristics.																			
1	Almost constant	Response to changes in load characteristics in every minute.																			
2	Slower change	Response to changes in load characteristics in every second.																			
3 *	Faster change	Obtain best suitable estimation in response to changes in load characteristics.																			
6	32	B	Real time auto tuning custom setup (To be continued)	-32768-32767	—	<p>When the operation mode of real time auto tuning is set to the customize (Pr 0.02 = 6), set the automatic adjusting function as shown below.</p> <table border="1"> <thead> <tr> <th>Bit</th> <th>Content</th> <th>Description</th> </tr> </thead> <tbody> <tr> <td>1-0</td> <td>Load characteristics estimation *1,*2</td> <td>Enable/disable the load characteristics estimation function. Setup value=0: Disable Setup value=1: Enable</td> </tr> <tr> <td>3-2</td> <td>Inertia ratio update *3</td> <td>Set up update to be made based on result of the load characteristics estimation of Pr 0.04 "Inertia ratio". Setup value=0: Use current setup. Setup value=1: Update by the estimated value.</td> </tr> <tr> <td>6-4</td> <td>Torque compensation *4</td> <td>Set up the update to be made according to the results of load characteristics estimation of Pr 6.07 "Torque command additional value", Pr 6.08 "positive direction torque compensation value" and Pr 6.09 "negative direction torque compensation value". Setup value = 0: Use current setup Setup value = 1: Disable torque compensation. Clear the parameters shown above to 0. Setup value = 2: Vertical axis mode Update Pr 6.07. Zero clear Pr 6.08 and Pr 6.09 Setup value = 3: Friction compensation (low) Update Pr 6.07. Set low compensation to Pr 6.08 and Pr 6.09. Setup value = 4: Friction compensation (middle) Set middle compensation to Pr 6.08 and Pr 6.09. Setup value = 5: Friction compensation (high) Set high compensation to Pr 6.08 and Pr 6.09.</td> </tr> </tbody> </table> <p>*1 If the load characteristics estimation is disabled, the current setup cannot be changed even if the inertia ratio is updated according to the estimated value. When the torque compensation is updated by the estimated value, it is cleared to 0 (invalid). *2 If the load characteristics estimation is abled, set Pr6.31 "Real-time auto tuning presumption speed" besides 0(stop estimation).</p>	Bit	Content	Description	1-0	Load characteristics estimation *1,*2	Enable/disable the load characteristics estimation function. Setup value=0: Disable Setup value=1: Enable	3-2	Inertia ratio update *3	Set up update to be made based on result of the load characteristics estimation of Pr 0.04 "Inertia ratio". Setup value=0: Use current setup. Setup value=1: Update by the estimated value.	6-4	Torque compensation *4	Set up the update to be made according to the results of load characteristics estimation of Pr 6.07 "Torque command additional value", Pr 6.08 "positive direction torque compensation value" and Pr 6.09 "negative direction torque compensation value". Setup value = 0: Use current setup Setup value = 1: Disable torque compensation. Clear the parameters shown above to 0. Setup value = 2: Vertical axis mode Update Pr 6.07. Zero clear Pr 6.08 and Pr 6.09 Setup value = 3: Friction compensation (low) Update Pr 6.07. Set low compensation to Pr 6.08 and Pr 6.09. Setup value = 4: Friction compensation (middle) Set middle compensation to Pr 6.08 and Pr 6.09. Setup value = 5: Friction compensation (high) Set high compensation to Pr 6.08 and Pr 6.09.			
Bit	Content	Description																			
1-0	Load characteristics estimation *1,*2	Enable/disable the load characteristics estimation function. Setup value=0: Disable Setup value=1: Enable																			
3-2	Inertia ratio update *3	Set up update to be made based on result of the load characteristics estimation of Pr 0.04 "Inertia ratio". Setup value=0: Use current setup. Setup value=1: Update by the estimated value.																			
6-4	Torque compensation *4	Set up the update to be made according to the results of load characteristics estimation of Pr 6.07 "Torque command additional value", Pr 6.08 "positive direction torque compensation value" and Pr 6.09 "negative direction torque compensation value". Setup value = 0: Use current setup Setup value = 1: Disable torque compensation. Clear the parameters shown above to 0. Setup value = 2: Vertical axis mode Update Pr 6.07. Zero clear Pr 6.08 and Pr 6.09 Setup value = 3: Friction compensation (low) Update Pr 6.07. Set low compensation to Pr 6.08 and Pr 6.09. Setup value = 4: Friction compensation (middle) Set middle compensation to Pr 6.08 and Pr 6.09. Setup value = 5: Friction compensation (high) Set high compensation to Pr 6.08 and Pr 6.09.																			

(To be continued)

Class	No.	Attribute *1)	Title	Range	Unit	Function												
6	32	B	Real time auto tuning custom setup (Continued)	-32768~32767	—	<table border="1"> <thead> <tr> <th>Bit</th> <th>Content</th> <th>Description</th> </tr> </thead> <tbody> <tr> <td>7</td> <td>Stiffness Setup *5</td> <td>Enable/disable the basic gain setup to be made according to Pr0.03 (Real-time auto-tuning machine stiffness setup). Setup value=0: Disable Setup value=1: Enable</td> </tr> <tr> <td>8</td> <td>Fixed parameter setup *5</td> <td>Enable/disable the change of parameter that is normally set at a fixed value. Setup value=0: Use current setup Setup value=1: Set to a fixed value.</td> </tr> <tr> <td>10-9</td> <td>Gain switching setup *5</td> <td>Select the gain switching related parameter to be used when the real time auto tuning is enabled. Setup value=0: Use current setup Setup value=1: Disable gain switching. Setup value=2: Enable gain switching.</td> </tr> </tbody> </table> <p>*3 If the inertia ratio update is enabled, set bit 1-0 to 1(enable). If neither is effective, the inertia ratio is not updated.</p> <p>*4 If the torque compensation is abled (setup value=2-5), set bit 3-2(Inertia ratio update) to 1(enable). If neither is effective, the inertia ratio is not updated. The torque compensation alone cannot be updated.</p> <p>*5 Set bit3-2(Inertia ratio update) to 1(enable) when this setting is set excluding 0. At this time, you can be set whether to inertia ratio update to be effective with bit 1-0(Load characteristics estimation).</p> <p>Caution) This parameter should be setup bit by bit. Because the operation is not guaranteed when the setting is wrong, use of the setup support software is recommended for parameter editing.</p> <p>Caution) Do not change while the motor is operating. With this parameter is updated, when the motor stopped after the result of load characteristic measurement secured.</p> <p>&lt;Setup procedure of bitwise parameter&gt; When setting parameter to a value other than 0, calculate the setup value of Pr 6.32 in the following procedure. 1) Identify the LSB of the setup. Example: LSB of the torque compensation function is 4. 2) Multiply the setup value by power of 2 (LSB). Example: To set the torque compensation function to friction compensation (middle): <math>2^4 \times 4 = 64</math>. 3) Perform steps 1) and 2) for every setup, sum up the values which are to be Pr 6.32 setup values. Example: Load characteristics measurement = enable, inertia ratio update = enable, torque compensation = friction compensation (middle), stiffness setup = enable, fixed parameter = set to a fixed value, gain switching setup = enable, then, <math>2^0 \times 1 + 2^2 \times 1 + 2^4 \times 4 + 2^7 \times 1 + 2^8 \times 1 + 2^9 \times 2 = 1477</math></p>	Bit	Content	Description	7	Stiffness Setup *5	Enable/disable the basic gain setup to be made according to Pr0.03 (Real-time auto-tuning machine stiffness setup). Setup value=0: Disable Setup value=1: Enable	8	Fixed parameter setup *5	Enable/disable the change of parameter that is normally set at a fixed value. Setup value=0: Use current setup Setup value=1: Set to a fixed value.	10-9	Gain switching setup *5	Select the gain switching related parameter to be used when the real time auto tuning is enabled. Setup value=0: Use current setup Setup value=1: Disable gain switching. Setup value=2: Enable gain switching.
Bit	Content	Description																
7	Stiffness Setup *5	Enable/disable the basic gain setup to be made according to Pr0.03 (Real-time auto-tuning machine stiffness setup). Setup value=0: Disable Setup value=1: Enable																
8	Fixed parameter setup *5	Enable/disable the change of parameter that is normally set at a fixed value. Setup value=0: Use current setup Setup value=1: Set to a fixed value.																
10-9	Gain switching setup *5	Select the gain switching related parameter to be used when the real time auto tuning is enabled. Setup value=0: Use current setup Setup value=1: Disable gain switching. Setup value=2: Enable gain switching.																
*1) For parameter attribute, refer to Section 9-1.																		

## 4) Parameters changed by real-time auto-gain tuning

The real-time auto-tuning function updates the following parameters according to Pr 0.02 “Real-time auto-tuning setup” and Pr 6.32 “Real-time auto-tuning custom setup” and by using the load characteristic estimate values.

Class	No.	Attribute *1)	Title	Range	Unit	Function
0	04	B	Inertia ratio	0–10000	%	Updates this parameter when the real-time auto-tuning inertia ratio update is enabled.
6	07	B	Torque command additional value	-100–100	%	Update this parameter when the vertical axis mode for real time auto-tuning is valid.
6	08	B	Positive direction Torque Compensation Value	-100–100	%	Update this parameter when the friction compensation mode for real time auto-tuning is valid.
6	09	B	Negative direction torque compensation value	-100–100	%	Update this parameter when the friction compensation mode for real time auto-tuning is valid.

The real-time auto-tuning function updates the following basic gain setup parameters according to Pr0.03 “Real-time auto-tuning machine stiffness setup”. For details, refer to 7) Basic gain parameter setup table.

Class	No.	Attribute *1))	Title	Range	Unit	Function
1	00	B	1st gain of position loop	0–30000	0.1/s	When stiffness setup is valid, updates the parameter based on the setup value.
1	01	B	1st gain of velocity loop	1–32767	0.1 Hz	When stiffness setup is valid, updates the parameter based on the setup value.
1	02	B	1st time constant of velocity loop integration	1–10000	0.1 ms	When stiffness setup is valid, updates the parameter based on the setup value.
1	04	B	1st time constant of torque filter	0–2500	0.01 ms	When stiffness setup is valid, updates the parameter based on the setup value.
1	05	B	2nd gain of position loop	0–30000	0.1/s	When stiffness setup is valid, updates the parameter based on the setup value.
1	06	B	2nd gain of velocity loop	1–32767	0.1 Hz	When stiffness setup is valid, updates the parameter based on the setup value.
1	07	B	2nd time constant of velocity loop integration	1–10000	0.1 ms	When stiffness setup is valid, updates the parameter based on the setup value.
1	09	B	2nd time constant of torque filter	0–2500	0.01 ms	When stiffness setup is valid, updates the parameter based on the setup value.

Real-time auto-tuning function sets the following parameters to the fixed value.

Class	No.	Attribute *1)	Title	Range	Unit	Function
1	03	B	1st filter of velocity detection	0–5	—	When fixed parameter setup is valid, set the parameter to 0.
1	08	B	2nd filter of velocity detection	0–5	—	When fixed parameter setup is valid, set the parameter to 0.
1	10	B	Velocity feed forward gain	0–1000	0.1%	When fixed parameter setup is valid, set the parameter to 300 (30%).
1	11	B	Velocity feed forward filter	1–6400	0.01 ms	When fixed parameter setup is valid, set the parameter to 50 (0.5 ms).
1	12	B	Torque feed forward gain	0–1000	0.1%	When fixed parameter setup is valid, set the parameter to 0.
1	13	B	Torque feed forward filter	0–6400	0.01 ms	When fixed parameter setup is valid, set the parameter to 0.

(To be continued)

The real-time auto-tuning function sets the following parameters as the gain is switched.

Class	No.	Attribute *1)	Title	Range	Unit	Function
1	14	B	2nd gain setup	0-1	—	Sets to 1 if the current setting is not maintained
1	15	B	Mode of position control switching	0-10	—	Sets to 10 to enable the gain switching. Sets to 0 to disable the gain switching.
1	16	B	Delay time of position control switching	0-10000	0.1 ms	Sets to 50 if the current setting is not maintained.
1	17	B	Level of position control switching	0-20000	—	Sets to 50 if the current setting is not maintained.
1	18	B	Hysteresis at position control switching	0-20000	—	Sets to 33 if the current setting is not maintained.
1	19	B	Position gain switching time	0-10000	0.1 ms	Sets to 33 if the current setting is not maintained.
1	20	B	Mode of velocity control switching	0-5	—	Sets to 0 if the current setting is not maintained.
1	21	B	Delay time of velocity control switching	0-10000	0.1 ms	Sets to 0 if the current setting is not maintained.
1	22	B	Level of velocity control switching	0-20000	—	Sets to 0 if the current setting is not maintained.
1	23	B	Hysteresis at velocity control switching	0-20000	—	Sets to 0 if the current setting is not maintained.
1	24	B	Mode of torque control switching	0-3	—	Sets to 0 if the current setting is not maintained.
1	25	B	Delay time of torque control switching	0-10000	0.1 ms	Sets to 0 if the current setting is not maintained.
1	26	B	Level of torque control switching	0-20000	—	Sets to 0 if the current setting is not maintained.
1	27	B	Hysteresis at torque control switching	0-20000	—	Sets to 0 if the current setting is not maintained.

The following settings are always set to invalid when Pr 0.02 “Real-time auto-tuning setup” is not 0.

However, the parameter settings are not changed.

Class	No.	Attribute *1)	Title	Range	Unit	Function
6	10	B	Function expansion setup	0-1023	—	Instantaneous velocity observer function enable bit (bit 0), disturbance observer function enable bit (bit 1) are internally disabled.
6	23	B	Load change compensation gain	-100-100	%	Parameter setup can be changed, but disturbance observer is disabled.
6	24	B	Load change compensation filter	10-2500	0.01 ms	Parameter setup can be changed, but disturbance observer is disabled.
6	73	B	Load estimation filter	0-2500	0.01 ms	When set to Pr 6.10 bit14=1 in case of stiffness setting is enabled, sets to 0.13 ms. When set to Pr 6.10 bit14=0, set to 0 ms.
6	74	B	Torque compensation frequency 1	0-5000	0.1 Hz	Regardless value of the Pr 6.10 bit 14, sets to 0.
6	75	B	Torque compensation frequency 2	0-5000	0.1 Hz	Regardless value of the Pr 6.10 bit14, sets to 0.
6	76	B	Load estimation count	0-8	-	When set to Pr 6.10 bit14=1 in case of stiffness setting is enabled, sets to 4.

\*1) For parameter attribute, refer to Section 9-1.



## 5) How to use

When Pr 0.02 (Setup of real-time auto-gain tuning mode) is set to a value other than 0, control parameter is automatically set according to Pr0.03 “Real-time auto-tuning machine stiffness setup”.

When the servo is ON, enter operation command after about 100ms. When the load characteristic is correctly estimated, Pr 0.04 Inertia ratio is updated. With certain mode settings, Pr 6.07 Torque command addition value, Pr 6.08 Positive direction compensation value and Pr 6.09 Negative direction compensation value will be changed.

When value of Pr0.03 “Real-time auto-tuning machine stiffness setup” is increased, the motor responsiveness will be improved. Determine the most appropriate stiffness in relation to the positioning setup time and vibration condition.

## 6) Other cautions

- [1] Immediately after the first servo-on upon start up; or after increasing Pr0.03 “Real-time auto-tuning machine stiffness setup”, abnormal sound or oscillation may be generated until the load characteristics is stabilized. If such abnormality lasts or repeats for 3 or more reciprocating operations, take the following countermeasures.
  - 1) Lower the setting value of Pr0.03 “Real-time auto-tuning machine stiffness setup”.
  - 2) Set Pr 0.02 Real-time auto-tuning setup to 0 to disable the real-time auto-tuning.
  - 3) Set Pr 0.04 Inertial ratio to the calculational value of the equipment and set Pr 6.07 Torque command addition value, Pr 6.08 Positive direction compensation value and Pr 6.09 Negative direction compensation value to 0.
- [2] When abnormal noise and oscillation occur, Pr 0.04 (Inertia ratio) or Pr 6.07 (Torque command additional value), Pr 6.08 (Positive direction torque compensation value), Pr 6.09 (Negative direction torque compensation value) might have changed to extreme values. Take the same measures as described in the setp 3) above in these cases.
- [3] Among the results of real-time auto-gain tuning, Pr 0.04 (Inertia ratio) and Pr 6.07 (Torque command additional value), Pr 6.08 (Positive direction torque compensation value), Pr 6.09 (Negative direction torque compensation value) will be written to EEPROM every 30 minutes. When you turn on the power again, the auto-gain tuning will be executed using the latest data as initial values. If power is turned off within 30 minutes after the end of tuning process, the result of the real-time auto-tuning is not saved. If the result is not saved, manually write parameters to EEPROM and then turn off power.
- [4] The control gain is updated when the motor is stopped. Therefore, if motor is not stopped because gain is excessively low or commands are given continually in one direction, the change in Pr0.03 “Real-time auto-tuning machine stiffness setup” may not be reflected. In this case, abnormal sound or oscillation may be generated depending on the stiffness setting that is reflected after the motor stops.  
After the stiffness setting is changed, be sure to stop the motor and check that the stiffness setting is reflected before performing next operation.

## 7) Basic gain parameter setup table

Stiffness	1st gain				2nd gain				For load fluctuation suppression function
	Pr 1.00	Pr 1.01	Pr 1.02	Pr 1.04	Pr 1.05	Pr 1.06	Pr 1.07 *1	Pr 1.09	Pr 6.24
	Position [0.1/s]	Velocity [0.1 Hz]	Velocity loop integration [0.1 ms]	Torque [0.01 ms]	Position [0.1/s]	Velocity [0.1 Hz]	Velocity loop integration [0.1 ms]	Torque [0.01 ms]	Load fluctuation compensation filter [0.01/ms]
0	20	15	3700	1500	25	15	10000	1500	2500
1	25	20	2800	1100	30	20	10000	1100	2500
2	30	25	2200	900	40	25	10000	900	2500
3	40	30	1900	800	45	30	10000	800	2500
4	45	35	1600	600	55	35	10000	600	2500
5	55	45	1200	500	70	45	10000	500	2500
6	75	60	900	400	95	60	10000	400	2500
7	95	75	700	300	120	75	10000	300	2120
8	115	90	600	300	140	90	10000	300	1770
9	140	110	500	200	175	110	10000	200	1450
10	175	140	400	200	220	140	10000	200	1140
11	320	180	310	126	380	180	10000	126	880
12	390	220	250	103	460	220	10000	103	720
13	480	270	210	84	570	270	10000	84	590
14	630	350	160	65	730	350	10000	65	450
15	720	400	140	57	840	400	10000	57	400
16	900	500	120	45	1050	500	10000	45	320
17	1080	600	110	38	1260	600	10000	38	270
18	1350	750	90	30	1570	750	10000	30	210
19	1620	900	80	25	1880	900	10000	25	180
20	2060	1150	70	20	2410	1150	10000	20	140
21	2510	1400	60	16	2930	1400	10000	16	110
22	3050	1700	50	13	3560	1700	10000	13	90
23	3770	2100	40	11	4400	2100	10000	11	80
24	4490	2500	40	9	5240	2500	10000	9	60
25	5000	2800	35	8	5900	2800	10000	8	60
26	5600	3100	30	7	6500	3100	10000	7	50
27	6100	3400	30	7	7100	3400	10000	7	50
28	6600	3700	25	6	7700	3700	10000	6	40
29	7200	4000	25	6	8400	4000	10000	6	40
30	8100	4500	20	5	9400	4500	10000	5	40
31	9000	5000	20	5	10500	5000	10000	5	40

\*1 In the vertical axis mode or friction compensation mode (Pr0.02=3,4), Pr1.07 is kept at 9999 until load characteristic estimation is completed.

## 5-1-2 Adaptive filter

This function estimates the resonance frequency from the vibrating component which appears on the motor velocity, and removes the resonance component from the torque command with adaptive filter, thus reduces the resonance vibration.

## 1) Applicable Range

This function works under the following condition.

Conditions under which the Adaptive filter is activated	
Control mode	Applies to other control modes than torque control.
Others	<ul style="list-style-type: none"> <li>• Should be servo-on status.</li> <li>• Elements other than control parameters, such as deviation counter clear command inhibit and torque limit are appropriately set, enabling the motor to run normally.</li> </ul>

## 2) Caution

In the following condition, normal operation may not be expected—manually set the notch filter to prevent resonance.

Conditions which obstruct adaptive filter action	
Resonance point	<ul style="list-style-type: none"> <li>• Resonance frequency is lower than the velocity response frequency <math>\times 3</math> (Hz).</li> <li>• Resonance peak is low, or control gain is low where the motor velocity is not affected by this.</li> <li>• Three or more resonance points exist.</li> </ul>
Load	<ul style="list-style-type: none"> <li>• Motor velocity variation with high harmonic component is generated due to non-linear factors such as backlash.</li> </ul>
Command	<ul style="list-style-type: none"> <li>• Acceleration/deceleration is rapid such as 30000 [r/min] per 1 [s].</li> </ul>

## 3) Relevant parameters

Set the operation of the adaptive filter to the following parameter.

Class	No.	Attribute *1)	Title	Range	Unit	Function
2	00	B	Adaptive filter mode setup	0-6	—	<p>Select the operation mode of adaptive filter:</p> <p>Setup value 0: Adaptive filter: invalid The adaptive filter is disabled. Parameters related to the 3rd and 4th notch filter hold the current value.</p> <p>Setup value 1: Adaptive filter: 1 filter is valid One adaptive filter is enabled. Parameters related to the 3rd notch filter will be updated based on adaptive performance.</p> <p>Setup value 2: Adaptive filter: 2 filters are valid Two adaptive filters are enabled. Parameters related to the 3rd and 4th notch filters will be updated based on adaptive performance.</p> <p>Setup value 3: Resonance frequency measurement mode Measure the resonance frequency. Result of measurement can be checked with the setup support software PANATERM. Parameters related to the 3rd and 4th notch filter hold the current value.</p> <p>Setup value 4: Clear result of adaptation Parameters related to the 3rd and 4th notch filter are disabled and results of adaptive operation are cleared.</p> <p>Setup value 5: High accurate adaptive filter Two adaptive filters are enabled. Parameters related to the third and fourth notch filter are updated depending on adaptive results. We recommend this setting when using two adaptive filters.</p> <p>Setup value 6: Maker uses. It is the fit gain function of setup support software PANATERM, and internally used. Do not use this setting in normal conditions.</p>

The adaptive filter automatically sets up the following parameters.

Class	No.	Attribute *1)	Title	Range	Unit	Function
2	07	B	3rd notch frequency	50-5000	Hz	Notch frequency is automatically set to the 1st resonance frequency estimated by the adaptive filter. In no resonance point is found, the frequency is set to 5000.
2	08	B	3rd notch width selection	0-20	—	Automatically set when the adaptive filter is active.
2	09	B	3rd notch depth selection	0-99	—	Automatically set when the adaptive filter is active.
2	10	B	4th notch frequency	50-5000	Hz	Notch frequency is automatically set to the 2nd resonance frequency estimated by the adaptive filter. In no resonance point is found, the frequency is set to 5000.
2	11	B	4rd notch width selection	0-20	—	Automatically set when 2 adaptive filters are active.
2	12	B	4rd notch depth selection	0-99	—	Automatically set when 2 adaptive filters are active.

\*1) For parameter attribute, refer to Section 9-1.

## 4) How to use

Enter the action command with Pr2.00 (Adaptive filter mode setup) set to a value other than 0.

If the resonance point affects the motor velocity, parameters of 3rd notch filter and/or 4th notch filters are automatically set according to the number of adaptive filters.

## 5) Other cautions

- (1) Immediately after the first servo-on at start up; or after increasing stiffness setting with the real-time auto-tuning enabled, abnormal sound or oscillation may be generated until the adaptive filter stabilizes. If such abnormality lasts or repeats for 3 or more reciprocating operations, take the following countermeasures.
  - 1) Write the parameters which have given the normal operation into EEPROM.
  - 2) Lower the setting value of Pr0.03 (Real-time auto-tuning machine stiffness setup).
  - 3) Invalidate the adaptive filter by setting Pr2.00 (Adaptive filter mode setup) to 0.
  - 4) Set up the notch filter manually.
- (2) Abnormal sound or oscillation may excessively change the setup value of 3rd and 4th notch filters. If such change occurs, disable the adaptive filter as described in step 3) above, change setup value of Pr 2.07 3rd notch frequency and Pr 2.10 "4th notch frequency" to 5000 (disable), and then enable the adaptive filter again.
- (3) The 3rd filters (Pr 2.07) and 4th notch filters (Pr 2.10) are written to EEPROM every 30minutes. Upon power up, these data are used as default values during adaptive process.

## 5-1-3 Real-time Auto Tuning (Two-degree-of-Freedom control mode Standard type)

The 2 degrees of freedom control mode has two types: standard type and synchronization type.

Standard type: This is a standard mode. Use this mode normally.

Synchronization type: Use this mode for locus control of multiple axes of an articulated robot, etc.

This item is an auto tuning function exclusive for the standard type.

Load characteristic of a machine is estimated on a real-time basis, and using the results, basic gain settings and friction compensation are automatically specified in accordance of hardness parameters.

## 1) Applicable Range

This function is enabled under the following conditions:

Conditions for real-time auto tuning	
Control mode	Position control, Velocity control, Torque control, Full-closed control Pr6.47 bit0=1 and bit3=0:2 Degrees of Freedom Control Mode Standard type
Other	· In Servo On status. · Parameters for other functions than control such as torque limit settings must be specified appropriately and normal rotation of motor must have no problems.

## 2) Cautions

- After the power is turned on, estimate value following may become quicker regardless of Pr6.31 “Real-time auto tuning estimation speed” until operation data effective for the estimation of load characteristics is sufficiently accumulated.
- When real-time auto-gain tuning is effective, an estimate value may become abnormal due to disturbance. If you want to obtain stable operation from when the power is turned on, it is recommended to disable the real-time auto-gain tuning.

Real-time auto tuning may not normally function in the following conditions. If that happens, change the load conditions/operation pattern or see the descriptions about manual tuning to manually configure relevant parameters.

Conditions hindering real-time auto tuning	
Load condition	· The load mass is too small or large with reference to the rotor mass (smaller than three times or 20 times or larger). · The load mass varies. · The mechanical stiffness is extremely low. · Any non-linear characteristic exists such as backlash.
Operation pattern	· Continuous use at a low speed of less than 100 [mm/s] · The acceleration is low at 2000 [mm/s] per 1 [s]. · A speed at 100 [mm/s] or higher or a acceleration/deceleration of 2000 [mm/s] per 1 [s] does not continue for 50 [ms] or longer. · The acceleration/deceleration torque is small with reference to the uneven load/ viscous friction torque.

## 3) Parameters controlling operation of real-time auto tuning

Configure the real-time auto tuning operation by setting the following parameters.

Class	No.	At-tribute *1)	Title	Range	Unit	Function		
0	02	B	Real-time auto-gain tuning setup	0-6	—	Specifies the operation mode of real-time auto tuning.		
						Setting	Mode	Description
						0,6	Invalid	The real-time auto tuning function is disabled.
						1	Standard response mode	The mode for the optimum stability. No uneven load or friction compensation takes place and no gain switching is used.
						2	High response mode 1	The mode for the optimum positioning. Used for a ball screw-driven device, etc. with no uneven load and little friction, as in a horizontal axis.
						3	High response mode 2	In addition to the high response mode 1, compensation against biased load and application of 3rd gain are made to reduce variations in settling time of positioning.
						4	High response mode 3 *1	In addition to the high response mode 2, settling time of positioning is reduced for a load where frictions are high.
						5	Load characteristic measurement	Basic gain settings and friction compensation settings are not changed and load characteristic estimation only is made. This is used in combination with setup support software.
6	Fit-gain mode	Use this mode to fine-adjust the stiffness setting after fit-gain has been completed.						
*1: In velocity control, it is the same as high response mode 2. In addition, Parameters of Pr6.08 "Positive direction torque compensation value", Pr6.09 "Negative direction torque compensation value" and Pr6.50 "Viscous friction compensation gain" are updated, but not reflected in the operation.								
0	03	B	Real-time auto-tuning machine stiffness setup	0-31	—	Specifies the response for enabled real-time auto tuning. A larger setting increases the speed response and servo stiffness but invites more vibration. Gradually increase the setting while monitoring the operation.		
6	10	B	Function expansion setup	-32768-32767	—	The automatic adjustment of load change inhibit function is enabled with bit14=1.		

(To be continued)

Class	No.	Attribute *1)	Title	Range	Unit	Function									
6	31	B	Real time auto tuning estimation speed	0-3	—	Specifies the load characteristics estimation speed for enabled real-time auto tuning. A larger setting allows faster follow-up to the variation in the load characteristics but also increases estimation fluctuation due to disturbance. The result of estimation is stored in the EEPROM every 30 minutes.									
						<table border="1"> <thead> <tr> <th>Setting</th> <th>Mode</th> <th>Description</th> </tr> </thead> <tbody> <tr> <td>0</td> <td>No change</td> <td>Terminates estimation of load characteristic.</td> </tr> <tr> <td>1</td> <td>Little change</td> <td>Responded against change of load characteristic on the order of minutes.</td> </tr> <tr> <td>2</td> <td>Gradual change</td> <td>Responded against change of load characteristic on the order of seconds.</td> </tr> <tr> <td>3 *</td> <td>Steep change</td> <td>Appropriate estimation is made against change of load characteristic.</td> </tr> </tbody> </table>	Setting	Mode	Description	0	No change	Terminates estimation of load characteristic.	1	Little change	Responded against change of load characteristic on the order of minutes.
Setting	Mode	Description													
0	No change	Terminates estimation of load characteristic.													
1	Little change	Responded against change of load characteristic on the order of minutes.													
2	Gradual change	Responded against change of load characteristic on the order of seconds.													
3 *	Steep change	Appropriate estimation is made against change of load characteristic.													
* If oscillation automatic detection is made valid from setup support software, this setting is ignored and operation is based on settings of setting value 3.															
6	32	B	Real time auto tuning custom setup	-32768- 32767	—	Not available in 2 degrees of freedom control mode. Always set to 0.									

\*1) For parameter attribute, refer to Section 9-1.



## 4) Parameter changed by real-time auto tuning

The real-time auto tuning function updates the following parameters using load characteristic values, in accordance with Pr0.02 "Real-time auto-gain tuning setup."

Class	No.	Attribute *1)	Title	Range	Unit	Function
0	04	B	Inertia ratio	0–10000	%	Updates this parameter when the real-time auto tuning inertia ratio update is enabled (Pr0.02=1 to 4).
6	07	B	Torque command additional value	-100–100	%	Updates this parameter when high response mode 2 or 3 (Pr0.02=3,4) for real-time auto tuning is selected.
6	08	B	Positive direction torque compensation value	-100–100	%	Updates this parameter when high response mode 3 (Pr0.02=4) for real-time auto tuning is selected.
6	09	B	Negative direction torque compensation value	-100–100	%	Updates this parameter when high response mode 3 (Pr0.02=3) for real-time auto tuning is selected.
6	50	B	Viscous friction compensating gain	0–10000	0.1%/ (10000r/min)	Updates this parameter when high response mode 3 (Pr0.02=3) for real-time auto tuning is selected.

The real-time auto tuning function updates the following basic gain setup parameters according to Pr0.03 "Real-time auto-tuning machine stiffness setup". For details, refer to 7) Basic gain parameter settings table.

Class	No.	Attribute *1)	Title	Range	Unit	Function
1	00	B	1st gain of position loop	0–30000	0.1/s	When stiffness setup is valid (Pr0.02=1 to 4), updates the parameter based on the setup value.
1	01	B	1st gain of velocity loop	1–32767	0.1 Hz	When stiffness setup is valid (Pr0.02=1 to 4), updates the parameter based on the setup value.
1	02	B	1st time constant of velocity loop integration	1–10000	0.1 ms	When stiffness setup is valid (Pr0.02=1 to 4), updates the parameter based on the setup value.
1	04	B	1st time constant of torque filter	0–2500	0.01 ms	When stiffness setup is valid (Pr0.02=1 to 4), updates the parameter based on the setup value.
1	05	B	2nd gain of position loop	0–30000	0.1/s	When stiffness setup is valid (Pr0.02=1 to 4), updates the parameter based on the setup value.
1	06	B	2nd gain of velocity loop	1–32767	0.1 Hz	When stiffness setup is valid (Pr0.02=1 to 4), updates the parameter based on the setup value.
1	07	B	2nd time constant of velocity loop integration	1–10000	0.1 ms	When stiffness setup is valid (Pr0.02=1 to 4), updates the parameter based on the setup value.
1	09	B	2nd time constant of torque filter	0–2500	0.01 ms	When stiffness setup is valid (Pr0.02=1 to 4), updates the parameter based on the setup value.
2	22	B	Command smoothing filter	0–10000	0.1 ms	When stiffness setup is valid (Pr0.02=1 to 4), updates the parameter based on the setup value. Sets the time constant for the command filter during 2 degrees of freedom control.
6	48	B	Adjust filter	0–2000	0.1 ms	When stiffness setup is valid (Pr0.02=1 to 4), updates the parameter based on the setup value.

Real-time auto-tuning function sets the following parameters to the fixed value.

Class	No.	Attribute *1)	Title	Range	Unit	Function
1	03	B	1st filter of velocity detection	0–5	–	When fixed parameter setup is valid (Pr0.02=1 to 4), set the parameter to 0.
1	08	B	2nd filter of velocity detection	0–5	–	When fixed parameter setup is valid (Pr0.02=1 to 4), set the parameter to 0.

(To be continued)

Class	No.	Attribute *1)	Title	Range	Unit	Function
1	10	B	Velocity feed forward gain	0–4000	0.1%	When fixed parameter setup is valid (Pr0.02=1 to 4), set the parameter to 1000 (100%).
1	11	B	Velocity feed forward filter	0–6400	0.01 ms	When fixed parameter setup is valid (Pr0.02=1 to 4), set the parameter to 0 (invalid).
1	12	B	Torque feed forward gain	0–2000	0.1%	When fixed parameter setup is valid (Pr0.02=1 to 4), set the parameter to 1000 (100%).
1	13	B	Torque feed forward filter	0–6400	0.01 ms	When fixed parameter setup is valid (Pr0.02=1 to 4), set the parameter to 0 (invalid).
6	10	B	Function expansion setup	-32768–32767	–	When fixed parameter setup is valid (Pr0.02=1 to 4), set the parameter to bit4=1.
6	49	B	Adjust/Torque command attenuation term	0–99	–	When fixed parameter setup is valid (Pr0.02=1 to 4), set the parameter to 15. When Pr0.02=6, set the tenths digit to 1 and maintain the unit digit.

The real-time auto-tuning function sets the following parameters as the gain is switched.

Class	No.	Attribute *1)	Title	Range	Unit	Function
1	14	B	2nd gain setup	0–1	–	Sets to 1 if the current setting is not maintained (Pr0.02=1 to 4).
1	15	B	Mode of position control switching	0–10	–	For the standard response mode (Pr0.02=1), set the parameter to 0. For high response mode 1 to 3 (Pr0.02=2 to 4), set the parameter to 7.
1	16	B	Delay time of position control switching	0–10000	0.1 ms	Sets to 10 if the current setting is not maintained (Pr0.02=1 to 4).
1	17	B	Level of position control switching	0–20000	–	Sets to 0 if the current setting is not maintained (Pr0.02=1 to 4).
1	18	B	Hysteresis at position control switching	0–20000	–	Sets to 0 if the current setting is not maintained (Pr0.02=1 to 4).
1	19	B	Position gain switching time	0–10000	0.1 ms	Sets to 10 if the current setting is not maintained (Pr0.02=1 to 4).
1	20	B	Mode of velocity control switching	0–5	–	Sets to 0 if the current setting is not maintained (Pr0.02=1 to 4).
1	21	B	Delay time of velocity control switching	0–10000	0.1 ms	Sets to 0 if the current setting is not maintained (Pr0.02=1 to 4).
1	22	B	Level of velocity control switching	0–20000	–	Sets to 0 if the current setting is not maintained (Pr0.02=1 to 4).
1	23	B	Hysteresis at velocity control switching	0–20000	–	Sets to 0 if the current setting is not maintained (Pr0.02=1 to 4).
1	24	B	Mode of torque control switching	0–3	–	Sets to 0 if the current setting is not maintained (Pr0.02=1 to 4).
1	25	B	Delay time of torque control switching	0–10000	0.1 ms	Sets to 0 if the current setting is not maintained (Pr0.02=1 to 4).

(To be continued)

Class	No.	Attribute *1)	Title	Range	Unit	Function
1	26	B	Level of torque control switching	0–20000	–	Sets to 0 if the current setting is not maintained (Pr0.02=1 to 4).
1	27	B	Hysteresis at torque control switching	0–20000	–	Sets to 0 if the current setting is not maintained (Pr0.02=1 to 4).
6	05	B	Position 3rd gain valid time	0–10000	0.1 ms	For the standard response mode or high response mode 1 (Pr0.02=1, 2), set the parameter to 0 (invalid). For high response mode 2 or 3 (Pr0.02=3,4), set the parameter to "Pr2.22 × 20". (However, the maximum value is limited to 10000.)
6	06	B	Position 3rd gain scale factor	50–1000	%	For the standard response mode or high response mode 1 (Pr0.02=1,2), set the parameter to 100 (100%). For high response mode 2 or 3 (Pr0.02=3,4), set the parameter to 200 (200%).

\*1) For parameter attribute, refer to Section 9-1.

When Pr0.02 “Real-time auto-gain tuning setup” = 1 to 4 or 6, the following settings and parameters are set automatic for enable/disable state of Pr 6.10 “Function expansion setup” load variation suppression function automatic adjustment.

Class	No.	Attribute *1)	Title	Range	Unit	Function
6	10	B	Function expansion setup	-32768–32767	–	When set to Pr 6.10 bit14=1, load variation suppression function will become enabled (bit1 = 1). When set to Pr 6.10 bit14=0, it is disabled (bit1 = 0).
6	23	B	Disturbance torque compensating gain	-100–100	%	When set to Pr 6.10 bit14=1, sets to 90%. When set to Pr 6.10 bit14=0, sets to 0%.
6	24	B	Disturbance observer filter	10–2500	0.01 ms	When set to Pr 6.10 bit14=1, updates to match rigidity. When set to Pr 6.10 bit14=0, value is held.
6	73	B	Load estimation filter	0–2500	0.01 ms	When set to Pr 6.10 bit14=1, sets to 0.13 ms. When set to Pr 6.10 bit14=0, sets to 0 ms.
6	74	B	Torque compensation frequency 1	0–5000	0.1 Hz	Regardless value of the Pr 6.10 bit 14, sets to 0.
6	75	B	Torque compensation frequency 2	0–5000	0.1 Hz	Regardless value of the Pr 6.10 bit 14, sets to 0.
6	76	B	Load estimation count	0–8	-	When set to Pr 6.10 bit14=1, sets to 4. When set to Pr 6.10 bit14=0, sets to 0.

\*1) For parameter attribute, refer to Section 9-1.

## 5) How to use

When Pr 0.02 (Setup of real-time auto-gain tuning mode) is set to a value other than 0, control parameter is automatically set according to Pr0.03 "Real-time auto-tuning machine stiffness setup".

When the servo is ON, enter operation command after about 100ms. When the load characteristic is correctly estimated, Pr 0.04 "Inertia ratio" is updated. With certain mode settings, Pr 6.07 "Torque command addition value", Pr 6.08 "Positive direction compensation value", Pr6.09 "Negative direction torque compensation value", and Pr6.50 "Viscous friction compensating gain." will be changed.

When value of Pr0.03 "Real-time auto-tuning machine stiffness setup" is increased, the motor responsiveness will be improved. Determine the most appropriate stiffness in relation to the positioning setup time and vibration condition.

## 6) Other cautions

- [1] Strange noises or vibrations may occur on the first action of turning on the servo immediately after startup or setting higher value of Pr0.03 "Real-time auto-tuning machine stiffness setup" until estimation of load characteristic becomes stable. This is not a fault if the function becomes stable soon. If oscillation or continued generation of abnormal noise through three or more reciprocating movements often occurs, take the following steps.
  - 1) Specify lower value for Pr0.03 "Real-time auto-tuning machine stiffness setup"
  - 2) Specify "0" for Pr0.02 "Real-time auto-gain tuning setup" and make real-time auto tuning invalid.
  - 3) Specify a theoretical value of device for Pr0.04 "Inertia ratio" and specify "0" for Pr6.07 "Torque command additional value", Pr6.08 "Positive direction torque compensation value", Pr6.09 "Negative direction torque compensation value" and Pr6.50 "Viscous friction compensating gain"
- [2] After occurrence of strange noises or vibrations, values of Pr0.04 "Inertia ratio", Pr6.07 "Torque command additional value", Pr6.08 "Positive direction torque compensation value", Pr6.09 "Negative direction torque compensation value", or Pr6.50 "Viscous friction compensating gain" may have been changed into extreme values. If this is the case, take Step 3) above.
- [3] The results of real-time automatic gain tuning, such as Pr0.04 "Inertia ratio," Pr6.07 "Torque command additional value", Pr6.08 "Positive direction torque compensation value", Pr6.09 "Negative direction torque compensation value", and Pr6.50 "Viscous friction compensating gain" are written in EEPROM in every 30 minutes. Upon restarting of power, auto tuning is performed using the data for initial values. The results of real-time auto gain tuning are not stored if the power is turned off before 30 minutes have elapsed. In this case, manually write the parameters to the EEPROM before turning off the power.
- [4] The control gain is updated when the motor is stopped. Therefore, if motor is not stopped because gain is excessively low or commands are given continually in one direction, the change in Pr0.03 "Real-time auto-tuning machine stiffness setup" may not be reflected. In this case, abnormal sound or oscillation may be generated depending on the stiffness setting that is reflected after the motor stops.  
After the stiffness setting is changed, be sure to stop the motor and check that the stiffness setting is reflected before performing next operation.
- [5] When real-time auto tuning is enabled under two-degree-of-freedom control mode, torque feed forward is disabled (equivalent to Pr1.12=0) regardless of the setting value in Pr1.12 "Torque feed forward gain." The state in which it operates with torque feed forward disabled will continue until the next operation is executed.
  - Set Pr1.12 to a value other than the current parameter (1000) after switching real-time auto tuning from enabled to disabled.

## 7) Basic gain parameter settings table

Stiffness	1st gain / 2nd gain				Command response		Tuning filter	For load fluctuation suppression function
	Pr1.00 Pr1.05	Pr1.01 Pr1.06	Pr1.02 Pr1.07	Pr1.04 Pr1.09	Pr2.22		Pr6.48 *1	Pr6.24
	Position [0.1/s]	Speed [0.1 Hz]	Velocity integral [0.1 ms]	Torque [0.01 ms]	Time constant [0.1 ms]		Time constant [0.1 ms]	Load fluctuation compensation filter [0.01/ms]
					Standard response mode	High response mode 1~3		
0	20	15	3700	1500	1919	764	155	2500
1	25	20	2800	1100	1487	595	115	2500
2	30	25	2200	900	1214	486	94	2500
3	40	30	1900	800	960	384	84	2500
4	45	35	1600	600	838	335	64	2500
5	55	45	1200	500	668	267	54	2500
6	75	60	900	400	496	198	44	2500
7	95	75	700	300	394	158	34	2120
8	115	90	600	300	327	131	34	1770
9	140	110	500	200	268	107	24	1450
10	175	140	400	200	212	85	23	1140
11	320	180	310	126	139	55	16	880
12	390	220	250	103	113	45	13	720
13	480	270	210	84	92	37	11	590
14	630	350	160	65	71	28	9	450
15	720	400	140	57	62	25	8	400
16	900	500	120	45	50	20	7	320
17	1080	600	110	38	41	17	6	270
18	1350	750	90	30	33	13	5	210
19	1620	900	80	25	28	11	5	180
20	2060	1150	70	20	22	9	4	140
21	2510	1400	60	16	18	7	4	110
22	3050	1700	50	13	15	6	3	90
23	3770	2100	40	11	12	5	3	80
24	4490	2500	40	9	10	4	3	60
25	5000	2800	35	8	9	4	2	60
26	5600	3100	30	7	8	3	2	50
27	6100	3400	30	7	7	3	2	50
28	6600	3700	25	6	7	3	2	40
29	7200	4000	25	6	6	2	2	40
30	8100	4500	20	5	6	2	2	40
31	9000	5000	20	5	5	2	2	40

\*1 There is that Pr6.48 “Adjust filter” adds 1 to by a combination of driver and motor.

## 5-1-4 Real-time Auto Tuning (Two-degree-of-Freedom control mode Synchronization type)

The 2 degrees of freedom control mode has two types: standard type and synchronization type.

Standard type: This is a standard mode. Use this mode normally.

Synchronization type: Use this mode for locus control of multiple axes of an articulated robot, etc.

This item is an auto tuning function exclusive for the synchronization type.

Load characteristic of a machine is estimated on a real-time basis, and using the results, basic gain settings and friction compensation are automatically specified in accordance of hardness parameters.

## 1) Applicable Range

This function is enabled under the following conditions:

Conditions for real-time auto tuning	
Control mode	Position Control(Semi-closed Control) Pr6.47 bit0=1 and bit3=1:2 Degrees of Freedom Control Mode Synchronization type
Other	<ul style="list-style-type: none"> <li>· In Servo On status.</li> <li>· Parameters for other functions than control such as torque limit settings must be specified appropriately and normal rotation of motor must have no problems.</li> </ul>

## 2) Cautions

- After the power is turned on, estimate value following may become quicker regardless of Pr6.31 "Real-time auto tuning estimation speed" until operation data effective for the estimation of load characteristics is sufficiently accumulated.
- When real-time auto-gain tuning is effective, an estimate value may become abnormal due to disturbance. If you want to obtain stable operation from when the power is turned on, it is recommended to disable the real-time auto-gain tuning.

Real-time auto tuning may not normally function in the following conditions. If that happens, change the load conditions/operation pattern or see the descriptions about manual tuning to manually configure relevant parameters.

Conditions hindering real-time auto tuning	
Load condition	<ul style="list-style-type: none"> <li>· The load mass is too small or large with reference to the rotor mass (smaller than three times or 20 times or larger).</li> <li>· The load mass varies.</li> <li>· The mechanical stiffness is extremely low.</li> <li>· Any non-linear characteristic exists such as backlash.</li> </ul>
Operation pattern	<ul style="list-style-type: none"> <li>· Continuous use at a low speed of less than 100 [mm/s]</li> <li>· The acceleration is low at 2000 [mm/s] per 1 [s].</li> <li>· A speed at 100 [mm/s] or higher or a acceleration/deceleration of 2000 [mm/s] per 1 [s] does not continue for 50 [ms] or longer.</li> <li>· The acceleration/deceleration torque is small with reference to the uneven load/ viscous friction torque.</li> </ul>

## 3) Parameters controlling operation of real-time auto tuning

Configure the real-time auto tuning operation by setting the following parameters.

Class	No.	At-tribute *1)	Title	Range	Unit	Function		
0	02	B	Real-time auto-gain tuning setup	0-6	-	Specifies the operation mode of real-time auto tuning.		
						Setting	Mode	Description
						0	Invalid	The real-time auto tuning function is disabled.
						1	Synchronization	Mode for synchronization control. Offset load compensation and friction compensation are not performed. The command filter will be maintained. Use this mode first. If there is any problem, use the other mode.
						2	Synchronous friction compensation	In addition to the synchronization mode, dynamic friction/viscous friction compensation is applied. Use this mode for a load with large friction.
						3	Stiffness setup	Inertia ratio estimation, offset load compensation, and friction compensation are not performed, and only the gain filter setup corresponding to the stiffness table is updated. For a load with large inertia variations, estimate the inertia in the synchronization mode, etc., and then use this mode.
						4	Load characteristic update	In the gain filter setup, only the inertia ratio and dynamic friction/viscous friction compensation are applied among load characteristics.
						5	Load characteristic measurement	Basic gain settings and friction compensation settings are not changed and load characteristic estimation only is made. This is used in combination with setup support software.
6	Load change support mode	Use this mode to make robust adjustments in load change.						
0	03	B	Real-time auto-tuning machine stiffness setup	0-31	-	Specifies the response for enabled real-time auto tuning. A larger setting increases the speed response and servo stiffness but invites more vibration. Gradually increase the setting while monitoring the operation.		
6	10	B	Function expansion setup	-32768 -32767	-	The automatic adjustment of load change inhibit function is enabled with bit14=1.		

(To be continued)

Class	No.	At-tribute *1)	Title	Range	Unit	Function															
6	31	B	Real time auto tuning estimation speed	0-3	-	<p>Specifies the load characteristics estimation speed for enabled real-time auto tuning. A larger setting allows faster follow-up to the variation in the load characteristics but also increases estimation fluctuation due to disturbance. The result of estimation is stored in the EEPROM every 30 minutes.</p> <table border="1"> <thead> <tr> <th>Setting</th> <th>Mode</th> <th>Description</th> </tr> </thead> <tbody> <tr> <td>0</td> <td>No change</td> <td>Terminates estimation of load characteristic.</td> </tr> <tr> <td>1</td> <td>Little change</td> <td>Responded against change of load characteristic on the order of minutes.</td> </tr> <tr> <td>2</td> <td>Gradual change</td> <td>Responded against change of load characteristic on the order of seconds.</td> </tr> <tr> <td>3 *</td> <td>Steep change</td> <td>Appropriate estimation is made against change of load characteristic.</td> </tr> </tbody> </table> <p>* If oscillation automatic detection is made valid from setup support software(PANATERM), this setting is ignored and operation is based on settings of setting value 3.</p>	Setting	Mode	Description	0	No change	Terminates estimation of load characteristic.	1	Little change	Responded against change of load characteristic on the order of minutes.	2	Gradual change	Responded against change of load characteristic on the order of seconds.	3 *	Steep change	Appropriate estimation is made against change of load characteristic.
Setting	Mode	Description																			
0	No change	Terminates estimation of load characteristic.																			
1	Little change	Responded against change of load characteristic on the order of minutes.																			
2	Gradual change	Responded against change of load characteristic on the order of seconds.																			
3 *	Steep change	Appropriate estimation is made against change of load characteristic.																			
6	32	B	Real time auto tuning custom setup	-32768-32767	-	Not available in 2 degrees of freedom control mode. Always set to 0.															

\*1) For parameter attribute, refer to Section 9-1.



## 4) Parameters changed by real-time auto-tuning

The real-time auto-tuning function updates the following parameters according to Pr0.02 "Real-time auto-tuning setup" by using the load characteristic estimate value.

Class	No.	Attribute *1)	Title	Range	Unit	Function
0	04	B	Inertia ratio	0-10000	%	Updates this parameter in the case of the synchronization mode (Pr0.02=1), synchronous friction compensation mode (Pr0.02=2) and load characteristic update mode (Pr0.02=4) for real-time auto-tuning.
6	08	B	Positive direction torque compensation value	-100-100	%	Updates this parameter in the case of the synchronous friction compensation mode (Pr0.02=2) and load characteristic update mode (Pr0.02=4) for real-time auto-tuning.
6	09	B	Negative direction torque compensation value	-100-100	%	Updates this parameter in the case of the synchronous friction compensation mode (Pr0.02=2) and load characteristic update mode (Pr0.02=4) for real-time auto-tuning.
6	50	B	Viscous friction compensating gain	0-10000	0.1%/ (10000r/min)	Updates this parameter in the case of the synchronous friction compensation mode (Pr0.02=2) and load characteristic update mode (Pr0.02=4) for real-time auto-tuning.

The real-time auto tuning function updates the following basic gain setup parameters according to Pr0.03 "Real-time auto-tuning machine stiffness setup". For details, refer to 7) Basic gain parameter settings table.

Class	No.	Attribute *1)	Title	Range	Unit	Function
1	00	B	1st gain of position loop	0-30000	0.1/s	In the case of the synchronization mode, synchronous friction compensation mode, stiffness setup mode, or load change support mode (Pr0.02=1 to 3, 6), updates the parameter based on the setup value.
1	01	B	1st gain of velocity loop	1-32767	0.1Hz	In the case of the synchronization mode, synchronous friction compensation mode, stiffness setup mode, or load change support mode (Pr0.02=1 to 3, 6), updates the parameter based on the setup value.
1	02	B	1st time constant of velocity loop integration	1-10000	0.1ms	In the case of the synchronization mode, synchronous friction compensation mode, stiffness setup mode, or load change support mode (Pr0.02=1 to 3, 6), updates the parameter based on the setup value.
1	04	B	1st time constant of torque filter	0-2500	0.01ms	In the case of the synchronization mode, synchronous friction compensation mode, stiffness setup mode, or load change support mode (Pr0.02=1 to 3, 6), updates the parameter based on the setup value.
1	05	B	2nd gain of position loop	0-30000	0.1/s	In the case of the synchronization mode, synchronous friction compensation mode, stiffness setup mode, or load change support mode (Pr0.02=1 to 3, 6), updates the parameter based on the setup value.
1	06	B	2nd gain of velocity loop	1-32767	0.1Hz	In the case of the synchronization mode, synchronous friction compensation mode, stiffness setup mode, or load change support mode (Pr0.02=1 to 3, 6), updates the parameter based on the setup value.
1	07	B	2nd time constant of velocity loop integration	1-10000	0.1ms	In the case of the synchronization mode, synchronous friction compensation mode, stiffness setup mode, or load change support mode (Pr0.02=1 to 3, 6), updates the parameter based on the setup value.
1	09	B	2nd time constant of torque filter	0-2500	0.01ms	In the case of the synchronization mode, synchronous friction compensation mode, stiffness setup mode, or load change support mode (Pr0.02=1 to 3, 6), updates the parameter based on the setup value.
6	48	B	Adjust filter	0-2000	0.1ms	In the case of the synchronization mode, synchronous friction compensation mode, stiffness setup mode, or load change support mode (Pr0.02=1 to 3, 6), updates the parameter based on the setup value.

(To be continued)

Real-time auto-tuning function sets the following parameters to the fixed value.

Class	No.	Attribute *1)	Title	Range	Unit	Function
1	03	B	1st filter of velocity detection	0–5	–	In the case of the synchronization mode, synchronous friction compensation mode, stiffness setup mode, or load change support mode (Pr0.02=1 to 3, 6), set the parameter to 0.
1	08	B	2nd filter of velocity detection	0–5	–	In the case of the synchronization mode, synchronous friction compensation mode, stiffness setup mode, or load change support mode (Pr0.02=1 to 3, 6), set the parameter to 0.
1	10	B	Velocity feed forward gain	0–4000	0.1%	In the case of the synchronization mode, synchronous friction compensation mode, stiffness setup mode, or load change support mode (Pr0.02=1 to 3, 6), set the parameter to 1000 (100%).
1	11	B	Velocity feed forward filter	0–6400	0.01ms	In the case of the synchronization mode, synchronous friction compensation mode, stiffness setup mode, or load change support mode (Pr0.02=1 to 3, 6), set the parameter to 0 (invalid).
1	12	B	Torque feed forward gain	0–2000	0.1%	In the case of the synchronization mode, synchronous friction compensation mode, stiffness setup mode, or load change support mode (Pr0.02=1 to 3, 6), set the parameter to 1000 (100%).
1	13	B	Torque feed forward filter	0–6400	0.01ms	In the case of the synchronization mode, synchronous friction compensation mode, stiffness setup mode, or load change support mode (Pr0.02=1 to 3, 6), set the parameter to 0 (invalid).
6	7	B	Torque command additional value	-100–100	%	In the case of the synchronous friction compensation mode (Pr0.02=2) or load characteristic update mode (Pr0.02=4), set the parameter to 0.
6	10	B	Function expansion setup	-32768–32767	–	In the case of the synchronization mode, synchronous friction compensation mode, stiffness setup mode, or load change support mode (Pr0.02=1 to 3, 6), set the parameter to bit4=1.
6	49	B	Adjust/Torque command attenuation term	0–99	–	In the case of the synchronization mode, synchronous friction compensation mode, stiffness setup mode, or load change support mode (Pr0.02=1 to 3, 6), set the tenths digit to 1 and maintain the unit digit.

The real-time automatic tuning sets the following parameters or uses the current settings, depending on Pr0.02 “Real-time auto-gain tuning setup”.

Class	No.	Attribute *1)	Title	Range	Unit	Function
1	14	B	2nd gain setup	0–1	–	Sets to 1 if the case of the synchronization mode, synchronous friction compensation mode, stiffness setup mode, or load change support mode (Pr0.02=1 to 3, 6).
1	15	B	Mode of position control switching	0–10	–	Sets to 0 if the case of the synchronization mode, synchronous friction compensation mode, stiffness setup mode, or load change support mode (Pr0.02=1 to 3, 6).
1	16	B	Delay time of position control switching	0–10000	0.1ms	Sets to 10 if the case of the synchronization mode, synchronous friction compensation mode, stiffness setup mode, or load change support mode (Pr0.02=1 to 3, 6).
1	17	B	Level of position control switching	0–20000	–	Sets to 0 if the case of the synchronization mode, synchronous friction compensation mode, stiffness setup mode, or load change support mode (Pr0.02=1 to 3, 6).
1	18	B	Hysteresis at position control switching	0–20000	–	Sets to 0 if the case of the synchronization mode, synchronous friction compensation mode, stiffness setup mode, or load change support mode (Pr0.02=1 to 3, 6).
1	19	B	Position gain switching time	0–10000	0.1ms	Sets to 10 if the case of the synchronization mode, synchronous friction compensation mode, stiffness setup mode, or load change support mode (Pr0.02=1 to 3, 6).
1	20	B	Mode of velocity control switching	0–5	–	Sets to 0 if the case of the synchronization mode, synchronous friction compensation mode, stiffness setup mode, or load change support mode (Pr0.02=1 to 3, 6).
1	21	B	Delay time of velocity control switching	0–10000	0.1ms	Sets to 0 if the case of the synchronization mode, synchronous friction compensation mode, stiffness setup mode, or load change support mode (Pr0.02=1 to 3, 6).
1	22	B	Level of velocity control switching	0–20000	–	Sets to 0 if the case of the synchronization mode, synchronous friction compensation mode, stiffness setup mode, or load change support mode (Pr0.02=1 to 3, 6).
1	23	B	Hysteresis at velocity control switching	0–20000	–	Sets to 0 if the case of the synchronization mode, synchronous friction compensation mode, stiffness setup mode, or load change support mode (Pr0.02=1 to 3, 6).
1	24	B	Mode of torque control switching	0–3	–	Sets to 0 if the case of the synchronization mode, synchronous friction compensation mode, stiffness setup mode, or load change support mode (Pr0.02=1 to 3, 6).

(To be continued)

Class	No.	Attribute *1)	Title	Range	Unit	Function
1	25	B	Delay time of torque control switching	0–10000	0.1ms	Sets to 0 if the case of the synchronization mode, synchronous friction compensation mode, stiffness setup mode, or load change support mode (Pr0.02=1 to 3, 6).
1	26	B	Level of torque control switching	0–20000	–	Sets to 0 if the case of the synchronization mode, synchronous friction compensation mode, stiffness setup mode, or load change support mode (Pr0.02=1 to 3, 6).
1	27	B	Hysteresis at torque control switching	0–20000	–	Sets to 0 if the case of the synchronization mode, synchronous friction compensation mode, stiffness setup mode, or load change support mode (Pr0.02=1 to 3, 6).

In case Pr 0.02 “Real-time auto-gain tuning setup” = 1 to 3, the following settings and parameters are set automatic for enable/disable state of Pr 6.10 “Function expansion setup” load variation suppression function automatic adjustment.

Class	No.	Attribute *1)	Title	Range	Unit	Function
6	10	B	Function extension setup	-32768 –32767	-	When set to Pr 6.10 bit14=1, load variation suppression function will become enabled (bit1 = 1). When set to Pr 6.10 bit14=0, it is disabled(bit1 = 0).
6	23	B	Load change compensation gain	-100– 100	%	When set to Pr 6.10 bit14=1, sets to 90%. When set to Pr 6.10 bit14=0, sets to 0%.
6	24	B	Load change compensation filter	10–2500	0.01 ms	When set to Pr 6.10 bit14=1, updates to match rigidity. When set to Pr 6.10 bit14=0, value is held.
6	73	B	Load estimation filter	0–2500	0.01 ms	When set to Pr 6.10 bit14=1, sets to 0.13 ms. When set to Pr 6.10 bit14=0, sets to 0 ms.
6	74	B	Torque compensation frequency 1	0–5000	0.1 Hz	Regardless value of the Pr 6.10 bit 14, sets to 0.
6	75	B	Torque compensation frequency 2	0–5000	0.1 Hz	Regardless value of the Pr 6.10 bit 14, sets to 0.
6	76	B	Load estimation count	0–8	-	When set to Pr 6.10 bit14=1, sets to 4. When set to Pr 6.10 bit14=0, sets to 0.

In case Pr 0.02 “Real-time auto-gain tuning setup” = 6 (load fluctuation response mode), the setting will be changed to the following:

Class	No.	Attribute *1)	Title	Range	Unit	Function
6	10	B	Function extension setup	-32768 –32767	-	Load fluctuation suppression function always become enabled (bit1 = 1, bit2=1, bit14=1)
6	23	B	Load change compensation gain	-100– 100	%	Sets to 100%.
6	24	B	Load change compensation filter	10–2500	0.01 ms	Updates to match rigidity.
6	73	B	Load estimation filter	0–2500	0.01 ms	Sets to 0.13 ms.
6	74	B	Torque compensation frequency 1	0–5000	0.1 Hz	Updates to match rigidity.
6	75	B	Torque compensation frequency 2	0–5000	0.1 Hz	Updates to match rigidity.
6	76	B	Load estimation count	0–8	-	Sets to 4.

\*1) For the parameter attributes, refer to Section 9-1.

## 5) How to use

When Pr0.02 "Real-time auto-tuning mode setup" is set to a value other than 0, control parameter is automatically set according to Pr0.03 "Real-time auto-tuning machine stiffness setup".

Enter an operation command when about 100 ms has elapsed after the servo was turned ON. When the load characteristic is correctly estimated, Pr0.04 "Inertia ratio" is updated. With certain mode settings, Pr6.07 "Torque command additional value", Pr6.08 "Positive direction torque compensation value", Pr6.09 "Negative direction torque compensation value", and Pr6.50 "Viscous friction compensating gain" will also be changed.

When the value of Pr0.03 "Real-time auto-tuning machine stiffness setup" is increased, the motor responsiveness will be improved. Determine the most appropriate stiffness in relation to the positioning setup time and vibration condition.

## 6) Other cautions

- [1] Immediately after the first servo-on upon start up; or after increasing Pr0.03 "Real-time auto-tuning machine stiffness setup", abnormal sound or oscillation may be generated until the load characteristics estimation is stabilized. It is not an abnormality if the load characteristic estimation is stabilized soon. If oscillation or abnormal sound lasts or repeats for 3 or more reciprocating operations, however, take the following countermeasures.
  - 1) Lower the setting value of Pr0.03 "Real-time auto-tuning machine stiffness setup".
  - 2) Set Pr0.02 "Real-time auto-tuning setup" to 0 to disable the real-time auto-tuning.
  - 3) Set Pr 0.04 "Inertial ratio" to the calculational value of the equipment and set Pr6.07 "Torque command additional value", Pr6.08 "Positive direction torque compensation value", Pr6.09 "Negative direction torque compensation value", and Pr6.50 "Viscous friction compensating gain" to 0.
- [2] When abnormal noise and oscillation occurs, Pr0.04 "Inertia ratio", Pr6.07 "Torque command additional value", Pr6.08 "Positive direction torque compensation value", Pr6.09 "Negative direction torque compensation value", and Pr6.50 "Viscous friction compensating gain" might have changed to extreme values. Take the same measures as described in step 3) above in these cases.
- [3] Among the results of real-time auto-gain tuning, Pr0.04 "Inertia ratio", Pr6.07 "Torque command additional value", Pr6.08 "Positive direction torque compensation value", Pr6.09 "Negative direction torque compensation value", and Pr6.50 "Viscous friction compensating gain" will be written to EEPROM every 30 minutes. When you turn on the power again, auto-tuning will be executed using the latest data as initial values. If power is turned off within 30 minutes after the end of the tuning process, the result of the real-time auto-gain tuning is not saved. If the result is not saved, manually write parameters to EEPROM and then turn off power.
- [4] The control gain is updated when the motor is stopped. Therefore, if the motor is not stopped because gain is excessively low or commands are given continually in one direction, the change in the set value for Pr0.03 "Real-time auto-tuning machine stiffness setup" may not be reflected. In this case, abnormal sound or oscillation may be generated depending on the stiffness setting that is reflected after the motor stops.  
After the stiffness setting is changed, be sure to stop the motor once and check that the stiffness setting has been reflected before performing the next operation.

7) Basic gain parameter setup table

Stiffness	1st gain / 2nd gain				Adjust filter	For load fluctuation suppression function	For load variation support mode (Pr0.02 = 6) only			
	Pr1.00 Pr1.05	Pr1.01 Pr1.06	Pr1.02 Pr1.07	Pr1.04 Pr1.09	Pr6.48 *1	Pr6.24	Pr1.00 Pr1.05	Pr6.24	Pr6.74	Pr6.75
	Position [0.1/s]	Velocity [0.1 Hz]	Velocity integration [0.1 ms]	Torque [0.01 ms]	Time constant [0.1 ms]	Load fluctuation compensation filter [0.01/ms]	Load fluctuation position loop gain 0.1 [1/s]	Load fluctuation compensation filter [0.01/ms]	Torque compensation frequency L 0.1 [Hz]	Torque compensation frequency H 0.1 [Hz]
0	20	15	3700	1500	155	2500	15	1330	25	7
1	25	20	2800	1100	115	2500	20	990	34	10
2	30	25	2200	900	94	2500	25	800	42	12
3	40	30	1900	800	84	2500	30	660	51	15
4	45	35	1600	600	64	2500	35	570	59	17
5	55	45	1200	500	54	2500	45	440	76	22
6	75	60	900	400	44	2500	60	330	104	30
7	95	75	700	300	34	2120	75	270	129	37
8	115	90	600	300	34	1770	90	220	153	44
9	140	110	500	200	24	1450	110	180	184	53
10	175	140	400	200	23	1140	140	140	231	66
11	320	180	310	126	16	880	180	110	290	83
12	390	220	250	103	13	720	220	90	346	99
13	480	270	210	84	11	590	270	70	413	118
14	630	350	160	65	9	450	350	60	512	146
15	720	400	140	57	8	400	400	50	570	163
16	900	500	120	45	7	320	500	40	678	194
17	1080	600	110	38	6	270	600	40	678	194
18	1350	750	90	30	5	210	750	40	678	194
19	1620	900	80	25	5	180	900	40	678	194
20	2060	1150	70	20	4	140	1150	40	678	194
21	2510	1400	60	16	4	110	1400	40	678	194
22	3050	1700	50	13	3	90	1700	40	678	194
23	3770	2100	40	11	3	80	2100	40	678	194
24	4490	2500	40	9	3	60	2500	40	678	194
25	5000	2800	35	8	2	60	2800	40	678	194
26	5600	3100	30	7	2	50	3100	40	678	194
27	6100	3400	30	7	2	50	3400	40	678	194
28	6600	3700	25	6	2	40	3700	40	678	194
29	7200	4000	25	6	2	40	4000	40	678	194
30	8100	4500	20	5	2	40	4500	40	678	194
31	9000	5000	20	5	2	40	5000	40	678	194

\*1 There is that Pr6.48 "Adjust filter" adds 1 to by a combination of driver and motor.

## 5-2 Manual adjusting function

As explained previously, MINAS-A6B series features the automatic gain tuning function, however, there might be some cases where this automatic gain tuning cannot be adjusted properly depending on the limitation on load conditions. Or you might need to readjust the tuning to obtain the optimum response or stability corresponding to each load.

Here we explain this manual gain tuning method by each control mode and function.

- 1) Block diagram of position control mode (5-2-1)
- 2) Block diagram of velocity control mode (5-2-2)
- 3) Block diagram of torque control mode (5-2-3)
- 4) Block diagram of full-closed control mode (5-2-4)
- 5) Gain switching function (5-2-5)
- 6) Notch filter (5-2-6)
- 7) Damping control (5-2-7)
- 8) Model type damping filter (5-2-8)
- 9) Feed forward function (5-2-9)
- 10) Load variation suppression function (5-2-10)
- 11) 3rd gain switching function (5-2-11)
- 12) Friction torque compensation (5-2-12)
- 13) Hybrid vibration suppression function (5-2-13)
- 14) Two-stage torque filter (5-2-14)
- 15) Quadrant projection suppression function (5-2-15)
- 16) Two-degree-of-freedom control mode (with position control) (5-2-16)
- 17) Two-degree-of-freedom control mode (with velocity control) (5-2-17)
- 18) Two-degree-of-freedom control mode (with full-closed control) (5-2-18)
- 19) Two-degree-of-freedom control mode (with velocity control) (5-2-19)
- 20) High response current control (5-2-20)

5-2-1 Block diagram of position control mode

Position control of MINAS-A6B series, there are four modes.

- Profile position mode (pp)
- Cyclic synchronous position mode (csp)
- Interpolated position mode (ip) (Not supported)
- Homing mode (hm)

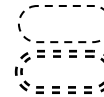
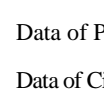
 Data of PANATERM  
 Data of CiA402 object

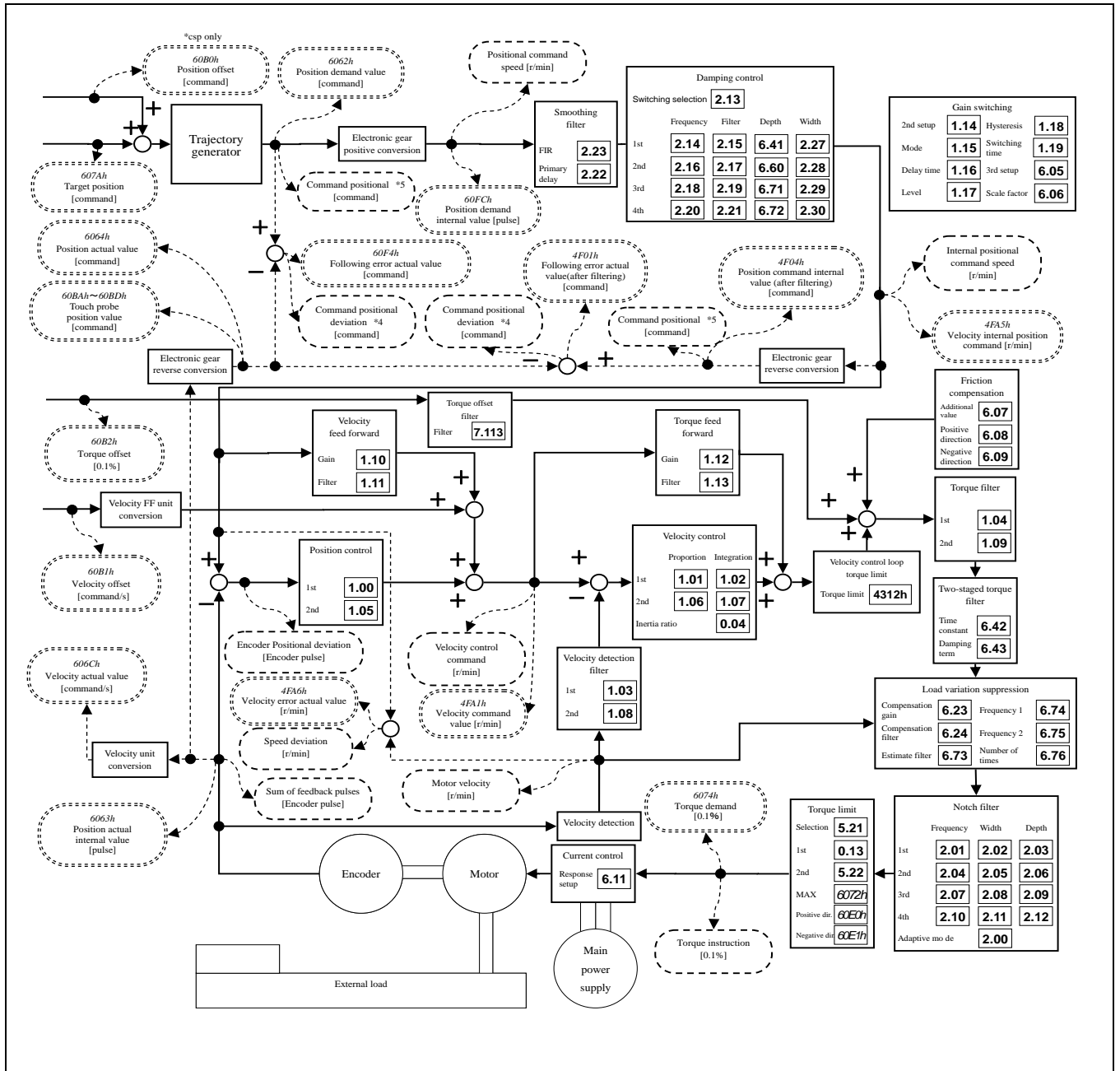



Block diagram of position control

- \*1) A slanting number shows (ex: *607Ah*) the object number of EtherCAT.
- \*2) A bold letter number shows (ex: **1.00**) a parameter number.
- \*3) Polarity was omitted.
- \*4) The method to calculate the positional deviation on PANATERM and Analog monitor varies depending on the setting of bit14 (command positional deviation output change) of Pr7.23 (Communication function extended setup 2).
- \*5) The position command on PANATERM can be switched depending on the setting of the bit3 (Command pulse accumulation value) of Pr7.99 (Communication function extended setup 6).
- \*6) When performing test run function, Z phase search, Frequency characteristic measurement (position loop characteristic) from the PANATERM, the driver switches to position control mode internally.
- \*7) Pr.7.113 (Torque offset filter) , 4312h (Velocity control loop torque limit) and 60E0h/60E1h (Positive/Negative torque limit value) are not supported in function extended edition 2 and earlier versions.

5-2-2 Block diagram of velocity control mode

Velocity control of MINAS-A6B series, there are two modes.

- Profile velocity mode (pv)
- Cyclic synchronous velocity mode (csv)

 Data of PANATERM  
 Data of CiA402 object

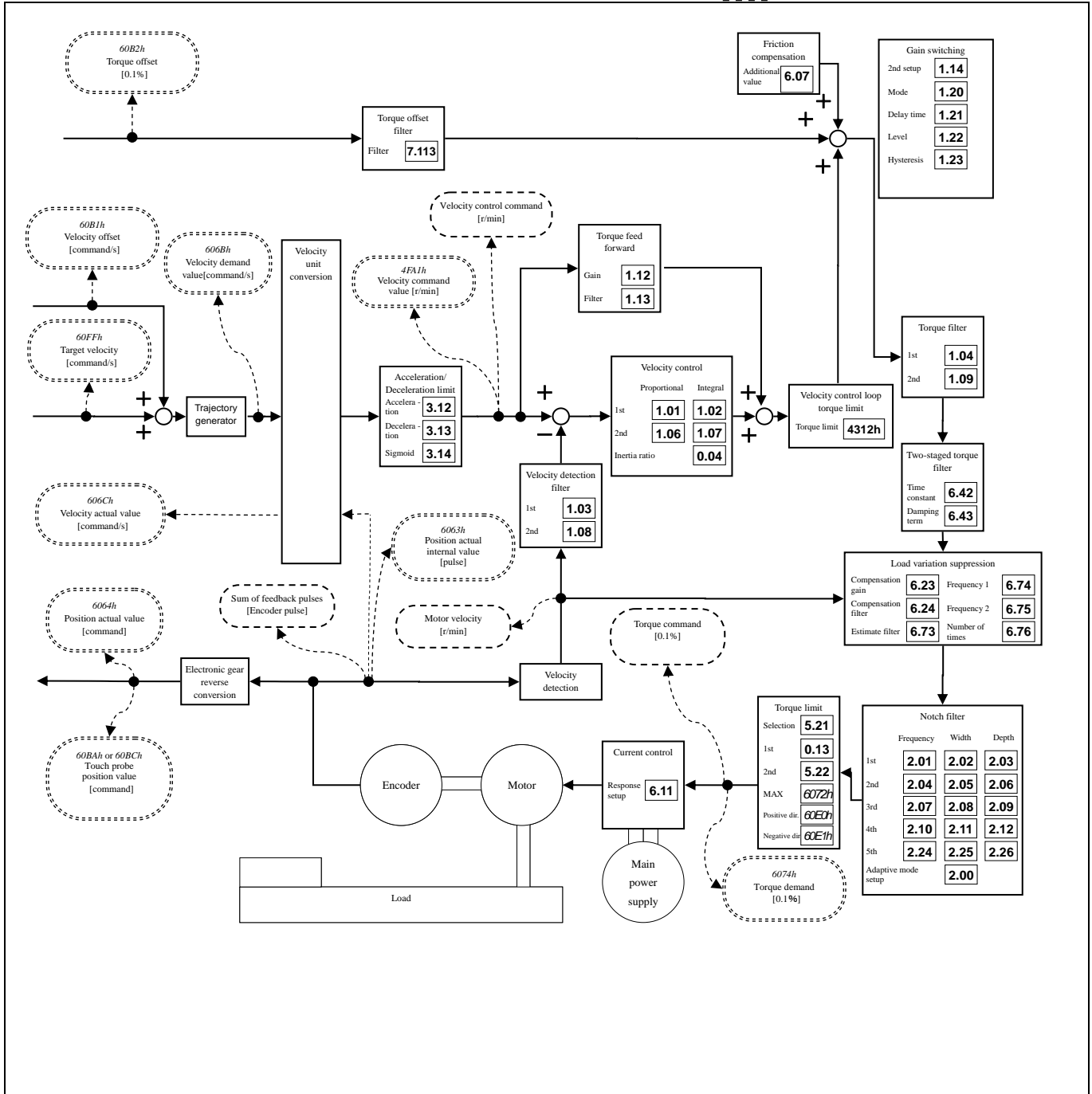

Block diagram of velocity control



- \*1) A slanting number shows (ex: 607Ah) the object number of EtherCAT.
- \*2) A bold letter number shows (ex:1.00) a parameter number.
- \*3) Polarity was omitted.
- \*4) When performing Frequency characteristic measurement (speed close loop characteristic, Torque speed(Vertical)) from the PANATERM, the driver switches to velocity control mode internally.
- \*5) Pr7.113 (Torque offset filter) , 4312h (Velocity control loop torque limit) and 60E0h/60E1h (Positive/Negative torque limit value) are not supported in function extended edition 2 and earlier versions.



5-2-3 Block diagram of torque control mode

Torque control of MINAS-A6B series, there are two modes.

- Profile torque mode (tq)
- Cyclic synchronous torque mode (cst)

 Data of PANATERM  
 Data of CiA402 object

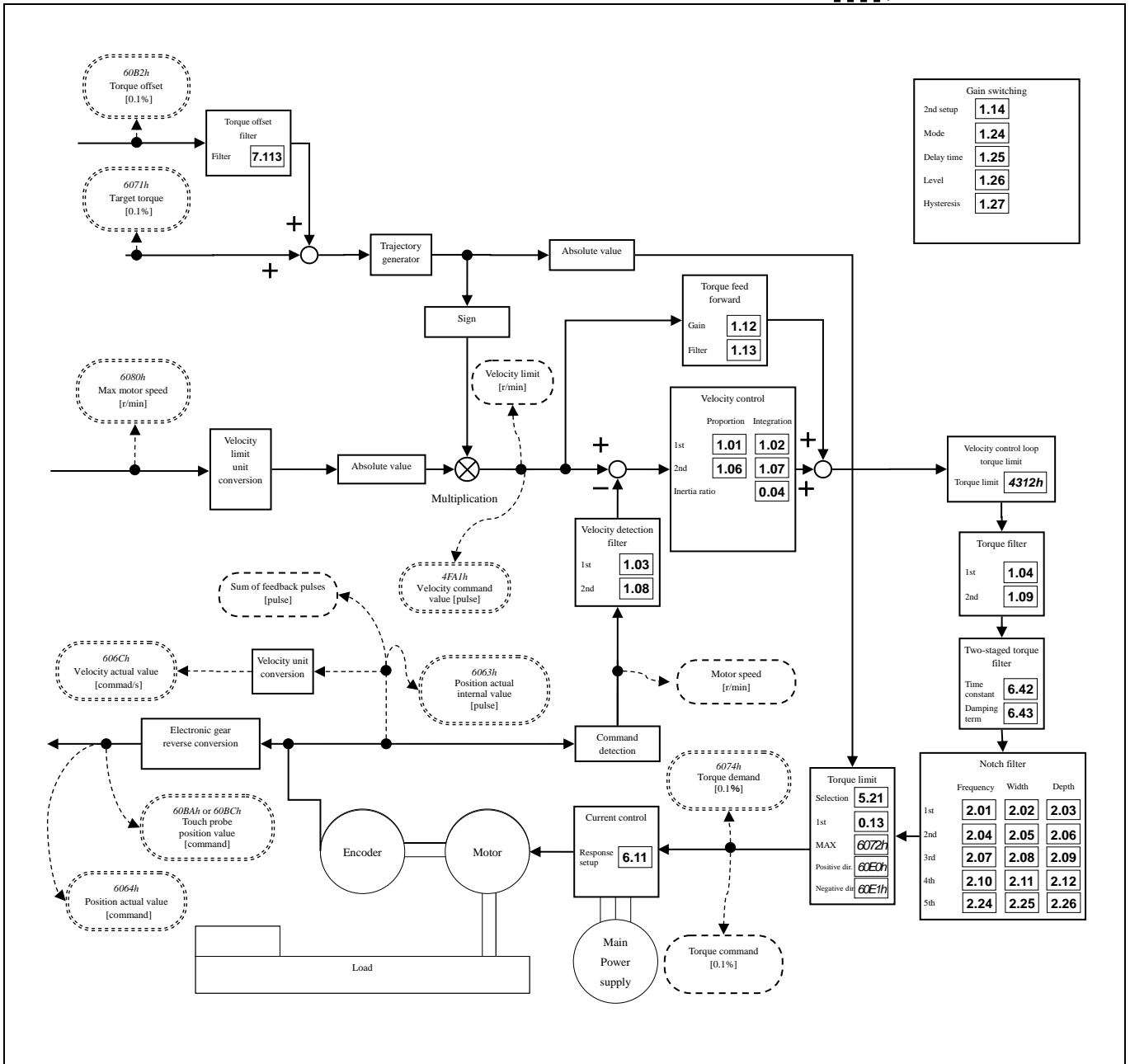

Block diagram of torque control

- \*1) A slanting number shows (ex: 607Ah) the object number of EtherCAT.
- \*2) A bold letter number shows (ex: **1.00**) a parameter number.
- \*3) Polarity was omitted.
- \*4) When performing Frequency characteristic measurement (Torque speed (normal)) from the PANATERM, the driver switches to torque control mode internally.
- \*5) Pr7.113 (Torque offset filter) , 4312h (Velocity control loop torque limit) and 60E0h/60E1h (Positive/Negative torque limit value) are not supported in function extended edition 2 and earlier versions.

[A6BE]: This function cannot be used.

5-2-4 Block diagram of full-closed control mode

Full-closed control of MINAS-A6B series, there are four modes.

- Profile position mode (pp)
- Cyclic synchronous position mode (csp)
- Interpolated position mode (ip) (Not supported)
- Homing mode (hm)

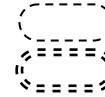
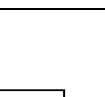
 Data of PANATERM  
 Data of CiA402 object

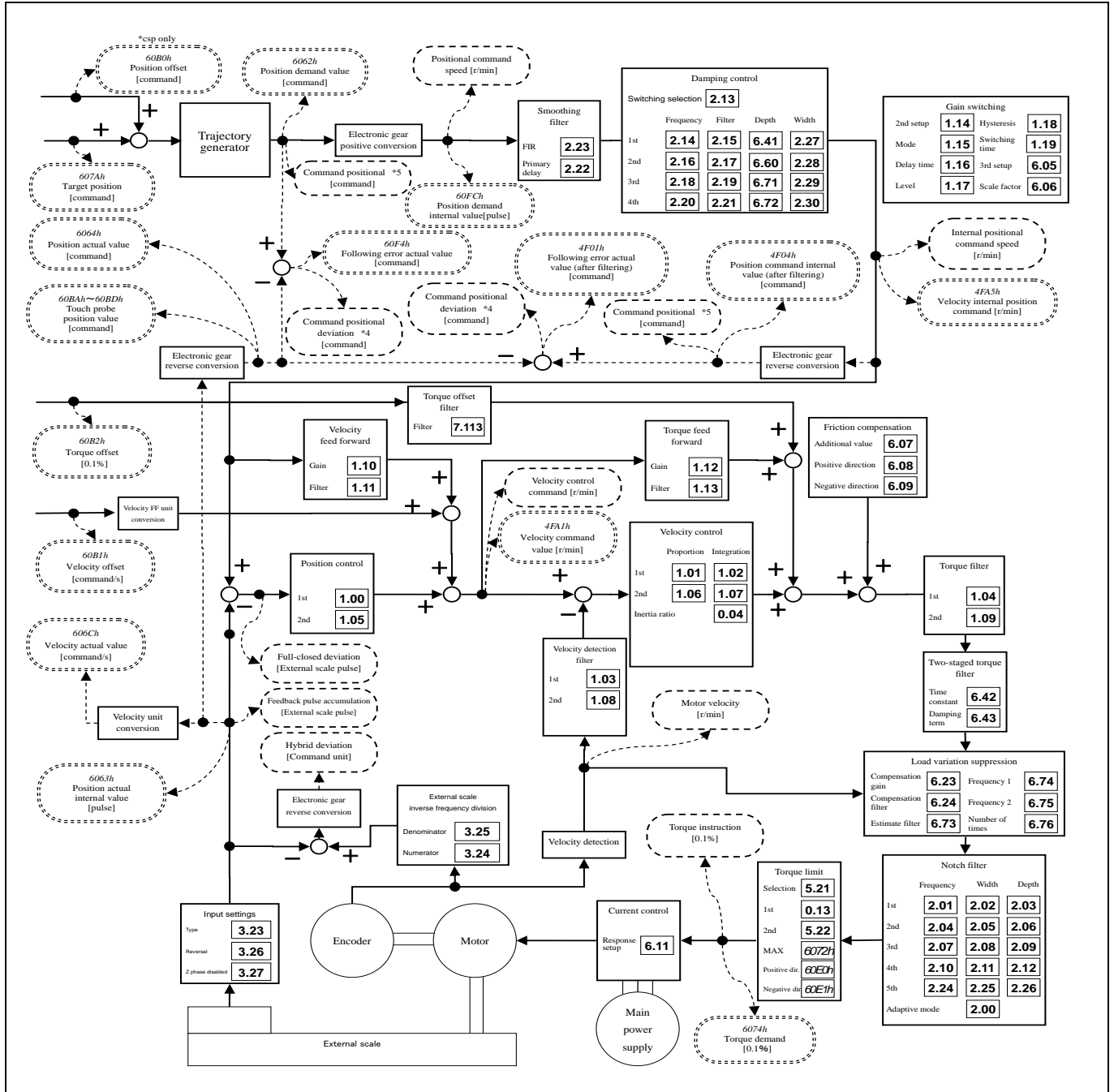

Block diagram of full-closed control

- \*1) A slanting number shows (ex: *607Ah*) the object number of EtherCAT.
- \*2) A bold letter number shows (ex: **1.00**) a parameter number.
- \*3) Polarity was omitted.
- \*4) The method to calculate the positional deviation on PANATERM and Analog monitor varies depending on the setting of bit14 (command positional deviation output change) of Pr 7.23 (Communication function extended setup 2).
- \*5) The position command on PANATERM can be switched depending on the setting of the bit3 (Command pulse accumulation value) of Pr7.99(Communication function extended setup 6).
- \*6) Pr7.113 (Torque offset filter) , 4312h (Velocity control loop torque limit) and 60E0h/60E1h (Positive/Negative torque limit value) are not supported in function extended edition 2 and earlier versions.

## 5-2-5 Gain Switching Function

By selecting appropriate gain based on internal data or external signal, the following effects can be obtained.

- Decrease the gain at the time of stoppage (servo lock) to reduce vibration.
- Increase the gain at the time of stoppage (setting) to shorten the settling time.
- Increase the gain during operation to improve command compliance.
- Based on condition of the equipment, change the gain with external signal.

## 1) Relevant parameters

Set the gain switching function using the following parameters.

Class	No.	Attribute *1)	Title	Range	Unit	Function																								
1	14	B	2nd gain setup	0–1	—	Arrange this parameter when performing optimum adjustment by using the gain switching function. 0: It is fixed to the 1st gain. 1: Enable gain switching of 1st gain (Pr 1.00–Pr 1.04) and 2nd gain (Pr 1.05–Pr 1.09).																								
1	15	B	Mode of position control switching	0–10	—	Set up the triggering condition of gain switching for position control. <table border="1"> <thead> <tr> <th>Setup value</th> <th>Switching condition</th> </tr> </thead> <tbody> <tr> <td>0</td> <td>Fixed to 1st gain</td> </tr> <tr> <td>1</td> <td>Fixed to 2nd gain</td> </tr> <tr> <td>2</td> <td>For manufacturer's use</td> </tr> <tr> <td>3</td> <td>Torque command</td> </tr> <tr> <td>4</td> <td>Invalid (Fixed to 1st gain)</td> </tr> <tr> <td>5</td> <td>Velocity command</td> </tr> <tr> <td>6</td> <td>Position deviation</td> </tr> <tr> <td>7</td> <td>Position command exists</td> </tr> <tr> <td>8</td> <td>Not in positioning complete</td> </tr> <tr> <td>9</td> <td>Actual speed</td> </tr> <tr> <td>10</td> <td>Position command exists + Actual speed</td> </tr> </tbody> </table>	Setup value	Switching condition	0	Fixed to 1st gain	1	Fixed to 2nd gain	2	For manufacturer's use	3	Torque command	4	Invalid (Fixed to 1st gain)	5	Velocity command	6	Position deviation	7	Position command exists	8	Not in positioning complete	9	Actual speed	10	Position command exists + Actual speed
Setup value	Switching condition																													
0	Fixed to 1st gain																													
1	Fixed to 2nd gain																													
2	For manufacturer's use																													
3	Torque command																													
4	Invalid (Fixed to 1st gain)																													
5	Velocity command																													
6	Position deviation																													
7	Position command exists																													
8	Not in positioning complete																													
9	Actual speed																													
10	Position command exists + Actual speed																													
1	16	B	Delay time of position control switching	0–10000	0.1 ms	For position controlling: When shifting from the 2nd gain to the 1st gain with Pr 1.15 Position control gain switching mode set at 3, 5, 6, 7, 8, 9 or 10, set up the delay time from trigger detection to the switching operation.																								
1	17	B	Level of position control switching	0–20000	Mode dependent	For position controlling: Set up triggering level when Pr 1.15 "Position control gain switching mode" is set at 3, 5, 6, 9 or 10. Unit of setting varies with switching mode. Note: Set the level equal to or higher than the hysteresis.																								
1	18	B	Hysteresis at position control switching	0–20000	Mode dependent	For position controlling: Set up triggering hysteresis when Pr 1.15 "Position control gain switching mode" is set at 3, 5, 6, 9 or 10. Unit of setting varies with switching mode. Note: When level < hysteresis, the hysteresis is internally adjusted so that it is equal to level.																								
1	19	B	Position gain switching time	0–10000	0.1 ms	For position controlling: If the difference between Pr 1.00 "1st gain of position loop" and Pr 1.05 "2nd gain of poison loop" is large, the increasing rate of position loop gain can be limited by this parameter. The position loop gain will increase over the time set.																								

(To be continued)

Class	No.	Attribute *1)	Title	Range	Unit	Function														
1	20	B	Mode of velocity control switching	0-5	—	For velocity controlling: Set the condition to trigger gain switching. <table border="1"> <thead> <tr> <th>Setup value</th> <th>Switching condition</th> </tr> </thead> <tbody> <tr> <td>0</td> <td>Fixed to 1st gain</td> </tr> <tr> <td>1</td> <td>Fixed to 2nd gain</td> </tr> <tr> <td>2</td> <td>For manufacturer's use</td> </tr> <tr> <td>3</td> <td>Torque command</td> </tr> <tr> <td>4</td> <td>Velocity command variation is larger.</td> </tr> <tr> <td>5</td> <td>Velocity command</td> </tr> </tbody> </table>	Setup value	Switching condition	0	Fixed to 1st gain	1	Fixed to 2nd gain	2	For manufacturer's use	3	Torque command	4	Velocity command variation is larger.	5	Velocity command
Setup value	Switching condition																			
0	Fixed to 1st gain																			
1	Fixed to 2nd gain																			
2	For manufacturer's use																			
3	Torque command																			
4	Velocity command variation is larger.																			
5	Velocity command																			
1	21	B	Delay time of velocity control switching	0-10000	0.1 ms	For velocity controlling: When shifting from the 2nd gain to the 1st gain with Pr 1.20 "Velocity control switching mode" set at 3, 4 or 5, set the delay time from trigger detection to the switching operation.														
1	22	B	Level of velocity control switching	0-20000	Mode dependent	For velocity controlling: Set up triggering level when Pr 1.20 Velocity control gain switching mode is set at 3, 4 or 5. Unit of setting varies with switching mode. Note: Set the level equal to or higher than the hysteresis.														
1	23	B	Hysteresis at velocity control switching	0-20000	Mode dependent	For velocity controlling: Set up triggering hysteresis when Pr 1.20 "Velocity control gain switching mode" is set at 3, 4 or 5. Unit of setting varies with switching mode. Note: When level < hysteresis, the hysteresis is internally adjusted so that it is equal to level.														
1	24	B	Mode of torque control switching	0-3	—	For torque controlling: Set the condition to trigger gain switching <table border="1"> <thead> <tr> <th>Setup value</th> <th>Switching condition</th> </tr> </thead> <tbody> <tr> <td>0</td> <td>Fixed to 1st gain</td> </tr> <tr> <td>1</td> <td>Fixed to 2nd gain</td> </tr> <tr> <td>2</td> <td>For manufacturer's use</td> </tr> <tr> <td>3</td> <td>Torque command</td> </tr> </tbody> </table>	Setup value	Switching condition	0	Fixed to 1st gain	1	Fixed to 2nd gain	2	For manufacturer's use	3	Torque command				
Setup value	Switching condition																			
0	Fixed to 1st gain																			
1	Fixed to 2nd gain																			
2	For manufacturer's use																			
3	Torque command																			
1	25	B	Delay time of torque control switching	0-10000	0.1 ms	For torque controlling: When shifting from the 2nd gain to the 1st gain with Pr 1.24 "Torque control switching mode" set at 3, set up the delay time from trigger detection to the switching operation.														
1	26	B	Level of torque control switching	0-20000	Mode dependent	For torque controlling: Set up triggering level when Pr 1.24 Torque control gain switching mode is set at 3. Unit varies depending on the setup of mode of control switching. Note: Set the level equal to or higher than the hysteresis.														
1	27	B	Hysteresis at torque control switching	0-20000	Mode dependent	For torque controlling: Set up triggering hysteresis when Pr 1.24 Torque control gain switching mode is set at 3. Unit of setting varies with switching mode. Note: When level < hysteresis, the hysteresis is internally adjusted so that it is equal to level.														

\*1) For parameter attribute, refer to Section 9-1.

## 2) How to use

Set the gain switching mode for the control mode to be used, and enable the gain switching function through Pr 1.14 2nd gain setup (set Pr 1.14 to 1).

Switching mode (Pr1.15) Setup value	Switching condition	Gain switching condition
0	Fixed to 1st gain	Fixed to the 1st gain (Pr 1.00 to Pr 1.04).
1	Fixed to 2nd gain	Fixed to the 2nd gain (Pr 1.05 to Pr 1.09).
2	For manufacturer's use	Please do not set.
3	Torque command is large	<ul style="list-style-type: none"> <li>Shift to the 2nd gain when the absolute value of the torque command exceeded (level + hysteresis) (%) previously with the 1st gain.</li> <li>Return to the 1st gain when the absolute value of the torque command was kept below (level-hysteresis) (%) previously during delay time with the 2nd gain.</li> </ul>
4	Velocity command variation is larger.	<ul style="list-style-type: none"> <li>Valid only during velocity control.</li> <li>Shift to the 2nd gain when the absolute value of the velocity command variations exceeded (level + hysteresis) (10 r/min/s) previously with the 1st gain.</li> <li>Return to the 1st gain when the absolute value of the velocity command variations was kept below (level-hysteresis) (10 r/min/s) during delay time previously with the 2nd gain.</li> </ul> <p>* The 1st gain is fixed while the velocity control is not applied.</p>
5	Velocity command is large	<ul style="list-style-type: none"> <li>Valid for position, velocity and full-closed controls.</li> <li>Shift to the 2nd gain when the absolute value of the velocity command exceeded (level +hysteresis) (r/min) previously with the 1st gain.</li> <li>Return to the 1st gain when the absolute value of the velocity command was kept below (level- hysteresis) (r/min) previously during delay time with the 2nd gain.</li> </ul>
6	Position deviation is large	<ul style="list-style-type: none"> <li>Valid for position and full-closed controls.</li> <li>Shift to the 2nd gain when the absolute value of the positional deviation exceeded (level +hysteresis) (pulse) previously with the 1st gain.</li> <li>Return to the 1st gain when the absolute value of the positional deviation was kept below (level-hysteresis) (pulse) previously over delay time with the 2nd gain.</li> </ul> <p>* Unit of level and hysteresis (pulse) is set as the encoder resolution for positional control and external scale resolution for full-closed control.</p> <p>* The positional deviation in these contents indicates the deviation between the internal command position and actual position after the filter regardless of the set value of Pr7.23: bit 14.</p>

(To be continued)

Switching mode (Pr1.15) Setup value	Switching condition	Gain switching condition
7	Position command exists	<ul style="list-style-type: none"> <li>Valid for position and full-closed controls.</li> <li>Shift to the 2nd gain when the positional command was not 0 previously with the 1st gain.</li> <li>Return to the 1st gain when the positional command was kept 0 previously during delay time with the 2nd gain.</li> </ul>
8	Not in positioning complete	<ul style="list-style-type: none"> <li>Valid for position and full-closed controls.</li> <li>Shift to the 2nd gain when the positioning was not completed previously with the 1st gain.</li> <li>Return to the 1st gain when the positioning was kept in completed condition previously during delay time with the 2nd gain.</li> </ul>
9	Actual speed is large	<ul style="list-style-type: none"> <li>Valid for position and full-closed controls.</li> <li>Shift to the 2nd gain when the absolute value of the actual speed exceeded (level + hysteresis) (r/min) previously with the 1st gain.</li> <li>Return to the 1st gain when the absolute value of the actual speed was kept below (level -hysteresis) (r/min) previously during delay time with the 2nd gain.</li> </ul>
10	Position command exists + Actual speed	<ul style="list-style-type: none"> <li>Valid for position and full-closed controls.</li> <li>Shift to the 2nd gain when the positional command was not 0 previously with the 1st gain.</li> <li>Return to the 1st gain when the positional command was kept at 0 during the delay time and the absolute value of actual speed was kept below (level-hysteresis) (r/min) previously with the 2nd gain.</li> </ul>

3) How to set

Suppose the load travels from A to B position and the internal status of the drive changes as the fig. below shows. Hereunder we explain how to set up the related parameters when you use the gain switching function.

1) Set up the conditions for gain switching with the following parameters.

Pr 1.15 "Mode of position control switching"

Pr 1.20 "Mode of velocity control switching"

Pr 1.24 "Mode of torque control switching"

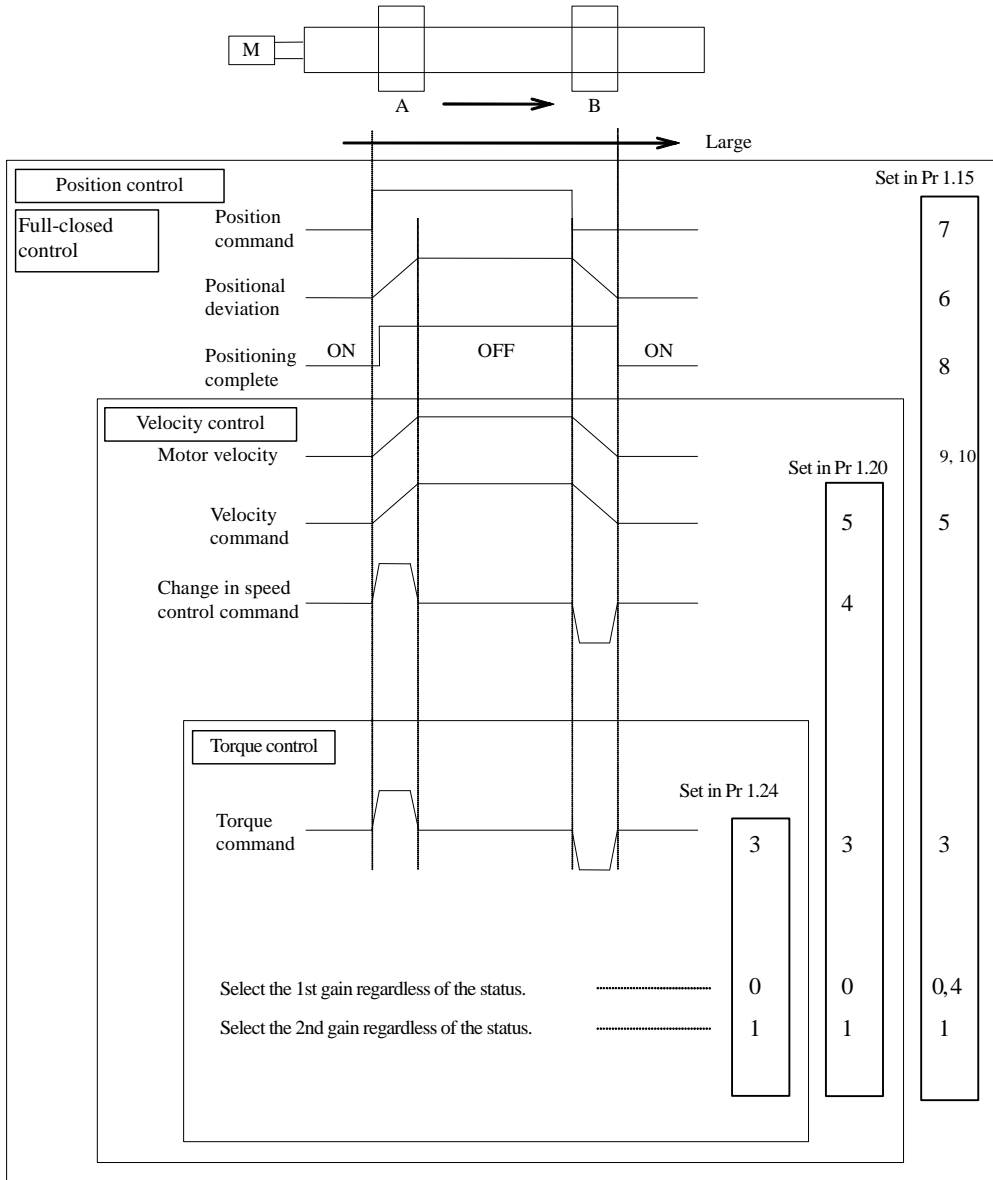

- 2) Set up the switching level and Hysterisis depending on the switching conditions.

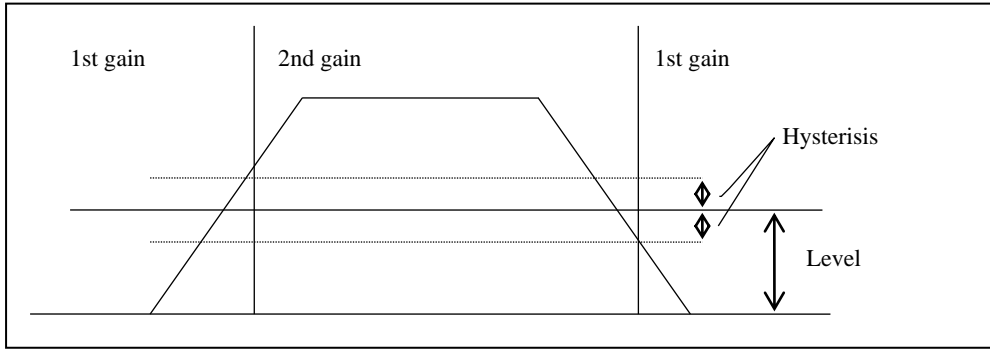

- 3) Set up the switching delay time.

Set up the time delay for switching from 2nd gain to 1st gain.

Switching conditions have to be established continuously during the switching delay time for the switching from the 2nd to the 1st.

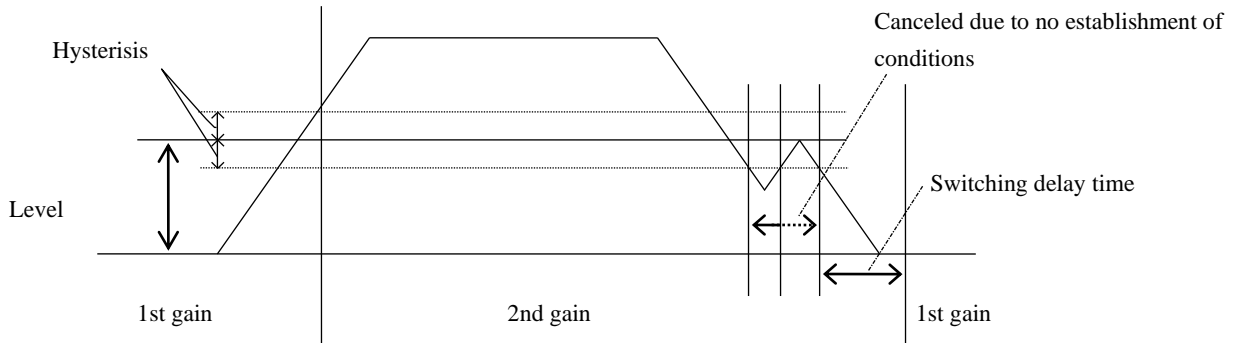

- 4) Set up the switching time of position gain.

Switch the position loop gain gradually to avoid any trouble caused by a rapid change to a higher gain, while the velocity loop gain, time constant of velocity loop integration, velocity detection filter and time constant of torque filter can be switched instantaneously.

\*The gain switching flag changes immediately when switching from low gain.

When Pr 1.19 (Position loop gain switching time) is 0,

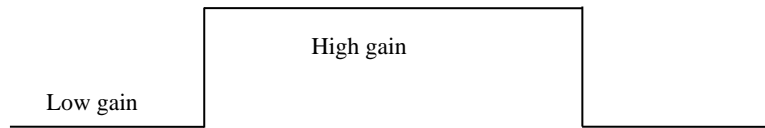

When Pr 1.19 (Position loop gain switching time) is 2,

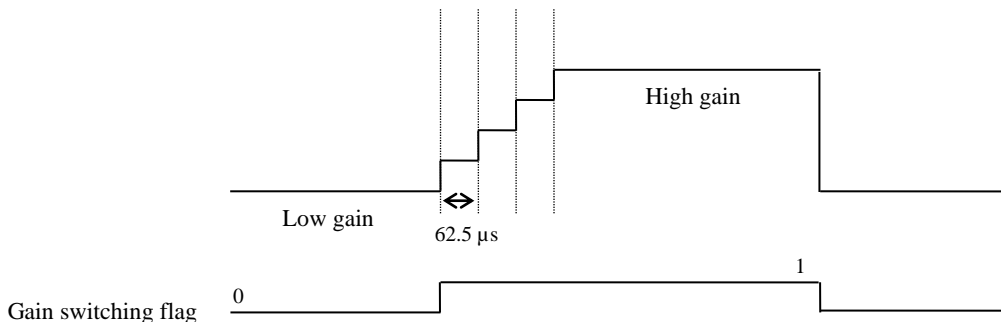



## 5-2-6 Notch filter

In case of low machine stiffness, you cannot set up a higher gain because vibration and noise occur due to oscillation caused by axis distortion or other causes. By suppressing the resonance peak at the notch filter, higher gain can be obtained or the level of vibration can be lowered.

## 1) Relevant parameters

MINAS-A6B series feature 5 normal notch filters. You can adjust frequency and width and depth.

Class	No.	Attribute *1)	Title	Range	Unit	Function
2	01	B	1st notch frequency	50-5000	Hz	Set the center frequency of the 1st notch filter. The notch filter function will be invalidated by setting up this parameter to "5000".
2	02	B	1st notch width selection	0-20	—	Set the width of notch at the center frequency of the 1st notch filter.
2	03	B	1st notch depth selection	0-99	—	Set the depth of notch at the center frequency of the 1st notch filter.
2	04	B	2nd notch frequency	50-5000	Hz	Set the center frequency of the 2nd notch filter. The notch filter function will be invalidated by setting up this parameter to "5000".
2	05	B	2nd notch width selection	0-20	—	Set the width of notch at the center frequency of the 2nd notch filter.
2	06	B	2nd notch depth selection	0-99	—	Set the depth of notch at the center frequency of the 2nd notch filter.
2	07	B	3rd notch frequency *2)	50-5000	Hz	Set the center frequency of the 3rd notch filter. The notch filter function will be invalidated by setting up this parameter to "5000".
2	08	B	3rd notch width selection *2)	0-20	—	Set the width of notch at the center frequency of the 3rd notch filter.
2	09	B	3rd notch depth selection *2)	0-99	—	Set the depth of notch at the center frequency of the 3rd notch filter.
2	10	B	4th notch frequency *2)	50-5000	Hz	Set the center frequency of the 4th notch filter. The notch filter function will be invalidated by setting up this parameter to "5000".
2	11	B	4th notch width selection *2)	0-20	—	Set the width of notch at the center frequency of the 4th notch filter.
2	12	B	4th notch depth selection *2)	0-99	—	Set the depth of notch at the center frequency of the 4th notch filter.
2	24	B	5th notch frequency	50-5000	Hz	Set the center frequency of the 5th notch filter. The notch filter function will be invalidated by setting up this parameter to "5000".
2	25	B	5th notch width selection	0-20	—	Set the width of notch at the center frequency of the 5th notch filter.
2	26	B	5th notch depth selection	0-99	—	Set the depth of notch at the center frequency of the 5th notch filter.

\*1) For parameter attribute, refer to Section 9-1.

\*2) When the applicable filtering function is used, parameter value is automatically set.

## 2) How to use

Determine the resonant frequency by using the frequency response measurement function of the setup support software, resonant frequency monitor or waveform graphics function and set it to the notch frequency.

## 3) Notch width and depth

The width of the notch filter is the ratio of the width of  $-3$  dB attenuation frequency band with respect to the notch frequency at its center when depth is 0, and the value is as shown in the table below.

The notch filter depth indicates I/O ratio where the input at the center frequency is completely shut with setup value 0 but fully received with setup value 100. The table below shows this value in dB on the right.

Notch width	
0	0.50
1	0.59
2	0.71
3	0.84
4	1.00
5	1.19
6	1.41
7	1.68
8	2.00
9	2.38
10	2.83
11	3.36
12	4.00
13	4.76
14	5.66
15	6.73
16	8.00
17	9.51
18	11.31
19	13.45
20	16.00

Notch depth	I/O ratio	[dB]
0	0.00	$-\infty$
1	0.01	-40.0
2	0.02	-34.0
3	0.03	-30.5
4	0.04	-28.0
5	0.05	-26.0
6	0.06	-24.4
7	0.07	-23.1
8	0.08	-21.9
9	0.09	-20.9
10	0.10	-20.0
15	0.15	-16.5
20	0.20	-14.0
25	0.25	-12.0
30	0.30	-10.5
35	0.35	-9.1
40	0.40	-8.0
45	0.45	-6.9
50	0.50	-6.0
60	0.60	-4.4
70	0.70	-3.1
80	0.80	-1.9
90	0.90	-0.9
100	1.00	0.0

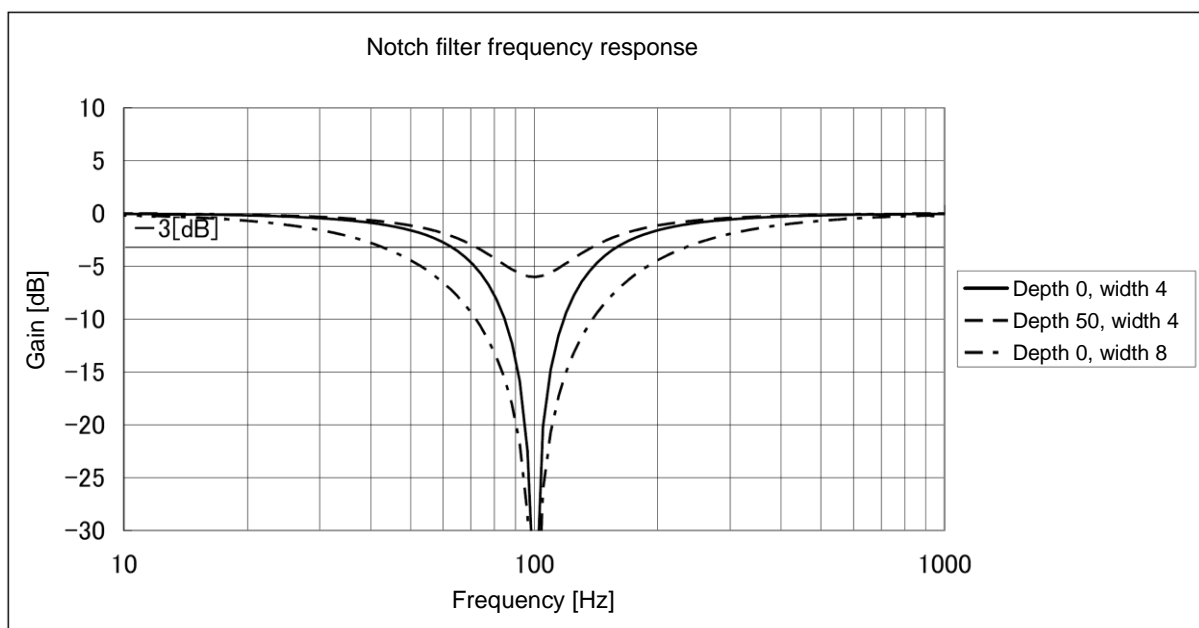

5-2-7 Damping Control

This function reduces the vibration at the top or on whole of the equipment by removing the vibration frequency components specified by the positional command. Up to 3 frequency settings, out of 4 settings in total, can be used simultaneously.

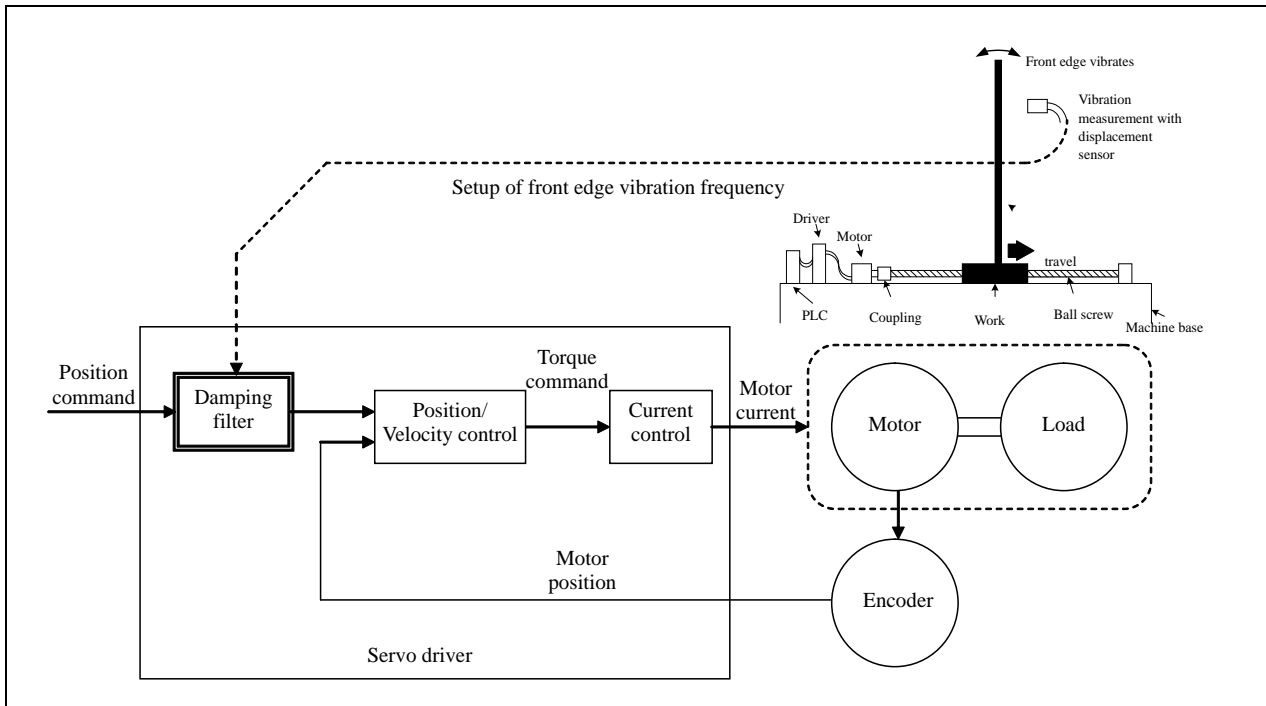

1) Applicable Range

Damping control is activated under the following conditions.

Conditions under which the damping control is activated	
Control mode	Position control mode or Full-closed control mode.

2) Caution

This function does not work properly or no effect is obtained under the following conditions.

Conditions which obstruct the damping control effect	
Load	<ul style="list-style-type: none"> <li>• Vibration is triggered by other factors than command (such as disturbance).</li> <li>• Ratio of resonance frequency and anti-resonance frequency is large.</li> <li>• Vibration frequency is out of the range of 0.5–300.0 [Hz].</li> </ul>

## 3) Relevant parameters

Set up damping control operation using the parameters shown below.

Class	No.	Attribute *1)	Title	Range	Unit	Function																																																														
2	13	B	Selection of damping filter switching	0-6	—	<p>Among 4 filters select the filters to be used for damping control.</p> <ul style="list-style-type: none"> <li>When setup value is 0: Up to 2 filters can be used simultaneously.</li> <li>When setup value is 1 or 2: Reserved for manufacturer's use (do not set this)</li> <li>With setup value 3: Select the filter with command direction.</li> </ul> <table border="1"> <tr> <td>Pr 2.13</td> <td>Position command direction</td> <td>1st damping</td> <td>2nd damping</td> <td>3rd damping</td> <td>4th damping</td> </tr> <tr> <td rowspan="2">3</td> <td>Positive direction</td> <td>Enabled</td> <td>Disabled</td> <td>Enabled</td> <td>Disabled</td> </tr> <tr> <td>Negative direction</td> <td>Disabled</td> <td>Enabled</td> <td>Disabled</td> <td>Enabled</td> </tr> </table> <p>Contents of setup values 4 to 6 will differ with enabled/disabled switching of two-degree-of-freedom control mode.</p> <ul style="list-style-type: none"> <li>Position control (Two-degree-of-freedom control mode disabled)</li> </ul> <table border="1"> <tr> <td>Pr 2.13</td> <td>1st damping</td> <td>2nd damping</td> <td>3rd damping</td> <td>4th damping</td> </tr> <tr> <td>4</td> <td>Enabled</td> <td>Enabled</td> <td>Enabled</td> <td>Disabled</td> </tr> <tr> <td>5, 6</td> <td colspan="4">Same as with setup value 0</td> </tr> </table> <ul style="list-style-type: none"> <li>Position control (Two-degree-of-freedom control mode enabled)</li> </ul> <table border="1"> <tr> <td>Pr. 2.13</td> <td>1st model-type damping</td> <td>2nd model-type damping</td> </tr> <tr> <td>4</td> <td>Enabled</td> <td>Enabled</td> </tr> <tr> <td>5</td> <td colspan="2">For manufacturer's use (do not set this)</td> </tr> </table> <table border="1"> <tr> <td>Pr. 2.13</td> <td>Position command direction</td> <td>1st model-type damping</td> <td>2nd model-type damping</td> </tr> <tr> <td rowspan="2">6</td> <td>Positive direction</td> <td>Enabled</td> <td>Disabled</td> </tr> <tr> <td>Negative direction</td> <td>Disabled</td> <td>Enabled</td> </tr> </table> <ul style="list-style-type: none"> <li>Full-closed control</li> </ul> <table border="1"> <tr> <td>Pr 2.13</td> <td>1st damping</td> <td>2nd damping</td> <td>3rd damping</td> <td>4th damping</td> </tr> <tr> <td>4-6</td> <td colspan="4">Same as with setup value 0</td> </tr> </table>	Pr 2.13	Position command direction	1st damping	2nd damping	3rd damping	4th damping	3	Positive direction	Enabled	Disabled	Enabled	Disabled	Negative direction	Disabled	Enabled	Disabled	Enabled	Pr 2.13	1st damping	2nd damping	3rd damping	4th damping	4	Enabled	Enabled	Enabled	Disabled	5, 6	Same as with setup value 0				Pr. 2.13	1st model-type damping	2nd model-type damping	4	Enabled	Enabled	5	For manufacturer's use (do not set this)		Pr. 2.13	Position command direction	1st model-type damping	2nd model-type damping	6	Positive direction	Enabled	Disabled	Negative direction	Disabled	Enabled	Pr 2.13	1st damping	2nd damping	3rd damping	4th damping	4-6	Same as with setup value 0			
Pr 2.13	Position command direction	1st damping	2nd damping	3rd damping	4th damping																																																															
3	Positive direction	Enabled	Disabled	Enabled	Disabled																																																															
	Negative direction	Disabled	Enabled	Disabled	Enabled																																																															
Pr 2.13	1st damping	2nd damping	3rd damping	4th damping																																																																
4	Enabled	Enabled	Enabled	Disabled																																																																
5, 6	Same as with setup value 0																																																																			
Pr. 2.13	1st model-type damping	2nd model-type damping																																																																		
4	Enabled	Enabled																																																																		
5	For manufacturer's use (do not set this)																																																																			
Pr. 2.13	Position command direction	1st model-type damping	2nd model-type damping																																																																	
6	Positive direction	Enabled	Disabled																																																																	
	Negative direction	Disabled	Enabled																																																																	
Pr 2.13	1st damping	2nd damping	3rd damping	4th damping																																																																
4-6	Same as with setup value 0																																																																			

(To be continued)

\*1 Switching between the damping frequency and damping filter setting is performed at the rising edge of the command that causes the number of command pluses per command detection period (0.125 ms) (at upstream of position command filter) changes from 0 to any other value while the positioning complete is being output.

Even if the control mode is changed to position control after changing the damping frequency and damping filter settings during velocity control or torque control, the setting is not changed.

Especially, at higher damping frequency, or if it becomes disabled, and wider positioning complete range is set up, and if large pulse (area is equivalent of time integration of the value of position command at upstream of the filter minus the value of position command at downstream of filter) remains in the filter during switching, it is rapidly discharged upon switching and returns to original position, and the motor will move at a speed higher than normal command velocity.

\*2 There is delay from setting change of damping frequency or damping filter to internal computation and application of new setting values. If the switching described in \*1 occurs during this delay time, application of new value will be suspended.

Class	No.	Attribute *1)	Title	Range	Unit	Function
2	14	B	1st damping frequency	0–3000	0.1 Hz	You can set up the 1st damping frequency of the damping control which suppresses vibration at the load edge. The driver measures vibration at load edge. Setup unit is 0.1 [Hz] The setup frequency is 0.5 to 300.0 [Hz]. Setup of 0 to 4 becomes invalid.
2	15	B	1st damping filter setup	0–1500	0.1 Hz	If torque saturation occurs with damping frequency 1st enabled, decrease the setup value, or if the operation is slow, increase it. Usually set it to 0. Note: The maximum setup value is internally limited to the corresponding damping frequency or 3000–damping frequency, whichever is smaller.
6	41	B	1st damping depth	0–1000	—	Specifies a depth corresponding to the 1st damping frequency. The depth is maximum if the setting value is 0. As the setting value increases, the depth decreases. As the depth increases, the damping effect increases, but the delay also increases. As the depth decreases, the delay decreases, but the damping effect also decreases. Use the parameter to fine adjust the damping effect and delay.
2	27	A	1st damping width setting	0–1000	-	Sets the width for the 1st damping frequency. The enabled range of setup is between 10 to 1000 and will operate as set to 100 between the range of 0 to 9. Within the setup range, the width will increase with the increase in the setup value, increasing robustness against vibration fluctuation.
2	16	B	2nd damping frequency	0–3000	0.1 Hz	You can set up the 2nd damping frequency of the damping control which suppresses vibration at the load edge. The driver measures vibration at load edge. Setup unit is 0.1 [Hz]. The setup frequency is 0.5 to 300.0 [Hz]. Setup of 0 to 4 becomes invalid.
2	17	B	2nd damping filter setup	0–1500	0.1 Hz	If torque saturation occurs with damping frequency 2nd enabled, decrease the setup value, or if the operation is slow, increase it. Usually set it to 0. Note: The maximum setup value is internally limited to the corresponding damping frequency or 3000–damping frequency, whichever is smaller.
6	60	A	2nd damping depth	0–1000	-	Defines the depth against the 2nd damping frequency. The depth becomes maximum when the setup value is 0. The larger the setup value, the smaller the depth. Although the damping effect increases as the depth becomes larger, the delay becomes large. While the delay decreases as the depth becomes smaller, the damping effect decreases. Use this parameter to fine tune the damping effect and delay.
2	28	A	2nd damping width setting	0–1000	-	Sets the width for the 2nd damping frequency. The enabled range of setup is between 10 to 1000 and will operate as set to 100 between the range of 0 to 9. Within the setup range, the width will increase with the increase in the setup value, increasing robustness against vibration fluctuation.
2	18	B	3rd damping frequency	0–3000	0.1 Hz	You can set up the 3rd damping frequency of the damping control which suppresses vibration at the load edge. The driver measures vibration at load edge. Setup unit is 0.1 [Hz] The setup frequency is 0.5 to 300.0 [Hz]. Setup of 0 to 4 becomes invalid.
2	19	B	3rd damping filter setup	0–1500	0.1 Hz	If torque saturation occurs with damping frequency 3rd enabled, decrease the setup value, or if the operation is slow, increase it. Usually set it to 0. Note: The maximum setup value is internally limited to the corresponding damping frequency or 3000–damping frequency, whichever is smaller.
6	71	A	3rd damping depth	0–1000	-	Defines the depth against the 3rd damping frequency. The depth becomes maximum if the setup value is 0. The larger the setup value, the smaller the depth. Although the damping effect increases as the depth becomes larger, the delay becomes large. While the delay decreases as the depth becomes smaller, the damping effect decreases. Use this parameter to fine tune the damping effect and delay.
2	29	A	3rd damping width setting	0–1000	-	Sets the width for the 3rd damping frequency. The enabled range of setup is between 10 to 1000 and will operate as set to 100 between the range of 0 to 9. Within the setup range, the width will increase with the increase in the setup value, increasing robustness against vibration fluctuation.

(To be continued)

Class	No.	Attribute *1)	Title	Range	Unit	Function
2	20	B	4th damping frequency	0-3000	0.1 Hz	You can set up the 4th damping frequency of the damping control which suppresses vibration at the load edge. The driver measures vibration at load edge. Setup unit is 0.1 [Hz] The setup frequency is 0.5 to 300.0 [Hz]. Setup of 0 to 4 becomes invalid.
2	21	B	4th damping filter setup	0-1500	0.1 Hz	If torque saturation occurs with damping frequency 4th enabled, decrease the setup value, or if the operation is slow, increase it. Usually set it to 0. Note: The maximum setup value is internally limited to the corresponding damping frequency or 3000-damping frequency, whichever is smaller.
6	72	B	4th damping depth	0-1000	-	Defines the depth against the 4th damping frequency. The depth becomes maximum if the setup value is 0. The larger the setup value, the smaller the depth. Although the damping effect increases as the depth becomes larger, the delay becomes large. While the delay decreases as the depth becomes smaller, the damping effect decreases. Use this parameter to fine tune the damping effect and delay.
2	30	B	4th damping width setting	0-1000	-	Sets the width for the 4th damping frequency. The enabled range of setup is between 10 to 1000 and will operate as set to 100 between the range of 0 to 9. Within the setup range, the width will increase with the increase in the setup value, increasing robustness against vibration fluctuation.

\*1) For parameter attribute, refer to Section 9-1.

- 4) How to use  
 (1) Setup of damping frequency (1st: Pr 2.14, 2nd: Pr 2.16, 3rd: Pr 2.18, 4th: Pr 2.20)

Measure the vibration frequency of the front edge of the machine. When you use such instrument as laser displacement meter, and can directly measure the load end vibration, read out the vibration frequency by 0.1 [Hz] from the measured waveform and enter it.

If suitable measuring device is not available, measure the frequency according to the residual vibration of the position deviation waveform measured by the vibration frequency monitor of the setup support software or a waveform graphic function.

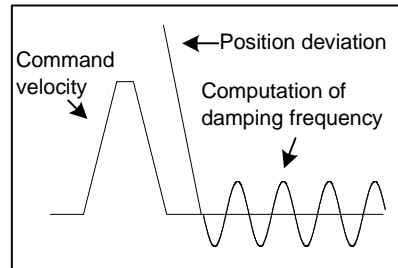

- (2) Setup of damping filter (1st: Pr 2.15, 2nd: Pr 2.17, 3rd: Pr 2.19, 4th: Pr 2.21)

First, set to 0 and check the torque waveform during operation.

You can reduce the settling time by setting up larger value, however, the torque ripple increases at the command changing point as the right fig. shows. Setup within the range where no torque saturation occurs under the actual condition. If torque saturation occurs, damping control effect will be lost.

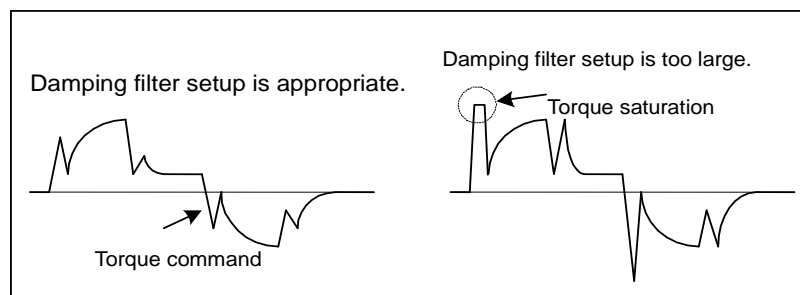

- (3) Setup of damping depth (Pr 6.41, Pr 6.60, Pr 6.71, Pr 6.72)  
 Setup of damping width (Pr 2.27, Pr 2.28, Pr 2.29, Pr 2.30)  
 First set it to 0, and increase the setting value little by little if settling time needs to be decreased. As the setting value increases, the settling time can be decreased, but the damping effect is also decreased. Make an adjustment while checking the statuses of the settling time and vibration.

## 5-2-8 Model-type damping filter

This function reduces vibration at the edge or over the entire equipment by removing the vibration frequency components specified by the positional command.

The model-type damping filter can also remove resonance frequency components as well as anti-resonance frequency components, enhancing the effect of a conventional damping filter to generate smooth torque commands and offering a better damping effect. In addition, the removal of anti-resonance frequency components and resonance frequency components can increase the responsiveness of the command response filter, which improves the settling time.

However, unlike a conventional damping filter, the model-type damping filter cannot obtain vibration components from the position sensor for the measurement of anti-resonance frequency components and resonance frequency components, which thus requires frequency characteristics analysis and the setting of optimum parameter values.

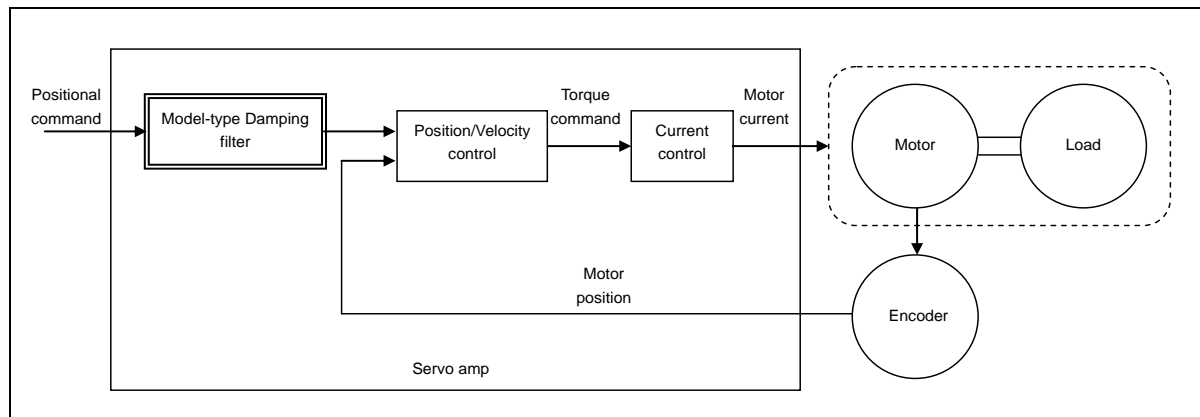

## 1) Applicable Range

The model-type damping filter is activated under the following conditions.

Conditions under which the model-type damping filter is activated	
Control mode	• Must be position controlled with two degree-of-freedom control enabled.

## 2) Caution

The model-type damping filter may not work properly or no effect can be obtained under the following conditions.

Conditions hindering the model-type damping filter	
Load condition	<ul style="list-style-type: none"> <li>• Vibrations are excited by factors other than commands (such as external forces).</li> <li>• The resonance frequency and the anti-resonance frequency are out of the range between 5.0 and 300.0 [Hz].</li> </ul>

The damping filter works in a conventional manner under the following conditions.

Conditions under which the damping filter works in a conventional manner	
Parameter setting	<ul style="list-style-type: none"> <li>• The resonance frequency and the anti-resonance frequency do not satisfy the following equation: 5.0 [Hz] or below <math>\leq</math> Anti-resonance frequency <math>\leq</math> Resonance frequency <math>\leq</math> 300.0 [Hz]</li> <li>• The response frequency and the anti-resonance frequency do not satisfy the following equation: 5.0 [Hz] or below <math>\leq</math> Anti-resonance frequency <math>\leq</math> Response frequency <math>\leq</math> Anti-resonance frequency <math>\times</math> 4 <math>\leq</math> 300.0 [Hz]</li> <li>• With the value in Pr. 2.13 "Damping filter switching selection" set to 4, the 1st and 2nd model-type damping filters are both enabled, and multiplying the 1st and 2nd response frequency/anti-resonance frequency ratios gives a value larger than 8. (In this case, only the 2nd model-type damping filter works as a conventional damping filter.)</li> </ul>

When the damping filter works in a conventional manner, the three parameters of anti-resonance frequency, anti-resonance attenuation ratio and response frequency will be used for damping frequency, damping depth and damping filter setting.

To completely disable this function, all of the five parameters of resonance frequency, resonance attenuation ratio, anti-resonance frequency, anti-resonance attenuation ratio and response frequency should be set to 0.



## 3) Relevant parameters

Set up the model-type damping filter using the following parameters.

Class	No.	At-tribute *1)	Title	Range	Unit	Function																																																																
2	13	B	Selection of damping filter switching	0-6	-	<p>Among 4 filters select the filters to be used for damping control.</p> <ul style="list-style-type: none"> <li>When setup value is 0: Up to 2 filters can be used simultaneously.</li> <li>When setup value is 1 or 2: Reserved for manufacturer's use (do not set this)</li> <li>With setup value 3: Select the filter with command direction.</li> </ul> <table border="1"> <thead> <tr> <th>Pr 2.13</th> <th>Position command direction</th> <th>1st damping</th> <th>2nd damping</th> <th>3rd damping</th> <th>4th damping</th> </tr> </thead> <tbody> <tr> <td>3</td> <td>Positive direction</td> <td>Enabled</td> <td>Disabled</td> <td>Enabled</td> <td>Disabled</td> </tr> <tr> <td></td> <td>Negative direction</td> <td>Disabled</td> <td>Enabled</td> <td>Disabled</td> <td>Enabled</td> </tr> </tbody> </table> <p>Contents of setup values 4 to 6 will differ with enabled/disabled switching of two-degree-of-freedom control mode.</p> <ul style="list-style-type: none"> <li>Position control (Two-degree-of-freedom control mode disabled)</li> </ul> <table border="1"> <thead> <tr> <th>Pr 2.13</th> <th>1st damping</th> <th>2nd damping</th> <th>3rd damping</th> <th>4th damping</th> </tr> </thead> <tbody> <tr> <td>4</td> <td>Enabled</td> <td>Enabled</td> <td>Enabled</td> <td>Disabled</td> </tr> <tr> <td>5, 6</td> <td colspan="4">Same as with setup value 0</td> </tr> </tbody> </table> <ul style="list-style-type: none"> <li>Position control (Two-degree-of-freedom control mode enabled)</li> </ul> <table border="1"> <thead> <tr> <th>Pr. 2.13</th> <th>1st model-type damping</th> <th>2nd model-type damping</th> </tr> </thead> <tbody> <tr> <td>4</td> <td>Enabled</td> <td>Enabled</td> </tr> <tr> <td>5</td> <td colspan="2">For manufacturer's use (do not set this)</td> </tr> </tbody> </table> <table border="1"> <thead> <tr> <th>Pr. 2.13</th> <th>Position command direction</th> <th>1st model-type damping</th> <th>2nd model-type damping</th> </tr> </thead> <tbody> <tr> <td>6</td> <td>Positive direction</td> <td>Enabled</td> <td>Disabled</td> </tr> <tr> <td></td> <td>Negative direction</td> <td>Disabled</td> <td>Enabled</td> </tr> </tbody> </table> <ul style="list-style-type: none"> <li>Full-closed control</li> </ul> <table border="1"> <thead> <tr> <th>Pr 2.13</th> <th>1st damping</th> <th>2nd damping</th> <th>3rd damping</th> <th>4th damping</th> </tr> </thead> <tbody> <tr> <td>4~6</td> <td colspan="4">Same as with setup value 0</td> </tr> </tbody> </table>	Pr 2.13	Position command direction	1st damping	2nd damping	3rd damping	4th damping	3	Positive direction	Enabled	Disabled	Enabled	Disabled		Negative direction	Disabled	Enabled	Disabled	Enabled	Pr 2.13	1st damping	2nd damping	3rd damping	4th damping	4	Enabled	Enabled	Enabled	Disabled	5, 6	Same as with setup value 0				Pr. 2.13	1st model-type damping	2nd model-type damping	4	Enabled	Enabled	5	For manufacturer's use (do not set this)		Pr. 2.13	Position command direction	1st model-type damping	2nd model-type damping	6	Positive direction	Enabled	Disabled		Negative direction	Disabled	Enabled	Pr 2.13	1st damping	2nd damping	3rd damping	4th damping	4~6	Same as with setup value 0			
Pr 2.13	Position command direction	1st damping	2nd damping	3rd damping	4th damping																																																																	
3	Positive direction	Enabled	Disabled	Enabled	Disabled																																																																	
	Negative direction	Disabled	Enabled	Disabled	Enabled																																																																	
Pr 2.13	1st damping	2nd damping	3rd damping	4th damping																																																																		
4	Enabled	Enabled	Enabled	Disabled																																																																		
5, 6	Same as with setup value 0																																																																					
Pr. 2.13	1st model-type damping	2nd model-type damping																																																																				
4	Enabled	Enabled																																																																				
5	For manufacturer's use (do not set this)																																																																					
Pr. 2.13	Position command direction	1st model-type damping	2nd model-type damping																																																																			
6	Positive direction	Enabled	Disabled																																																																			
	Negative direction	Disabled	Enabled																																																																			
Pr 2.13	1st damping	2nd damping	3rd damping	4th damping																																																																		
4~6	Same as with setup value 0																																																																					
6	61	B	1st resonance frequency	0-3000	0.1Hz	Defines the resonance frequency of the model-type damping filter's load. The unit is [0.1 Hz].																																																																
6	62	B	1st resonance attenuation ratio	0-1000	-	Defines the resonance attenuation ratio of the model-type damping filter's load. The attenuation ratio can be set as the setup value multiplied by 0.001. The value of 1000 results in an attenuation of 1 (no peak). The smaller the setup value, the smaller the attenuation ratio (higher resonance peak).																																																																
6	63	B	1st anti-resonance frequency	0-3000	0.1Hz	Defines the anti-resonance frequency of the model-type damping filter's load. The unit is [0.1 Hz].																																																																

(To be continued)

Class	No.	Attribute *1)	Title	Range	Unit	Function
6	64	B	1st anti-resonance attenuation ratio	0-1000	-	Defines the anti-resonance attenuation ratio of the model-type damping filter's load. The attenuation ratio can be set as the setup value multiplied by 0.001. The value of 1000 results in an attenuation of 1 (no peak). The smaller the setup value, the smaller the attenuation ratio (higher resonance peak).
6	65	B	1st response frequency	0-3000	0.1Hz	Defines the response frequency of the model-type damping filter's load. The unit is [0.1 Hz].
6	66	B	2nd resonance frequency	0-3000	0.1Hz	Defines the 2nd resonance frequency of the model-type damping filter's load. The unit is [0.1 Hz].
6	67	B	2nd resonance attenuation ratio	0-1000	-	Defines the 2nd resonance attenuation ratio of the model-type damping filter's load. The attenuation ratio can be set as the setup value multiplied by 0.001. The value of 1000 results in an attenuation of 1 (no peak). The smaller the setup value, the smaller the attenuation ratio (higher resonance peak).
6	68	B	2nd anti-resonance frequency	0-3000	0.1Hz	Defines the 2nd anti-resonance frequency of the model-type damping filter's load. The unit is [0.1 Hz].
6	69	B	2nd anti-resonance attenuation ratio	0-1000	-	Defines the 2nd anti-resonance attenuation ratio of the model-type damping filter's load. The attenuation ratio can be set as the setup value multiplied by 0.001. The value of 1000 results in an attenuation of 1 (no peak). The smaller the setup value, the smaller the attenuation ratio (higher resonance peak).
6	70	B	2nd response frequency	0-3000	0.1Hz	Defines the 2nd response frequency of the model-type damping filter's load. The unit is [0.1 Hz].

\*1) For parameter attribute, refer to Section 9-1.

## 4) How to use

[1] As preparation, measure the resonance frequency and anti-resonance frequency using the frequency characteristic measuring function of setup support software PANATERM with torque velocity mode.

Ex.) The figure below shows the measurement result with a belt device. Ignoring small resonances, the resonance frequency at the gain peak and the anti-resonance frequency at the gain valley are as follows:

1st resonance frequency = 130 [Hz], 1st anti-resonance frequency = 44 [Hz]

2nd resonance frequency = 285 [Hz], 2nd anti-resonance frequency=180 [Hz]

[2] The resonance attenuation ratio and anti-resonance attenuation ratio should have initial values of around 50 (0.050).

[3] The response frequency should start with the same value as the anti-resonance frequency.

[4] Specify a value of 4 to 6 in Pr. 2.13 “Selection of damping filter switching” to enable model-type damping control.

[5] Activate the motor and fine tune the parameters in the following sequence so that vibration components including command position deviation become small.

(1) Anti-resonance frequency

(2) Anti-resonance attenuation ratio

(3) Resonance frequency

(4) Resonance attenuation ratio

[6] Once the setting where vibration is minimized was found, increase the setup value of response frequency. The response frequency increases from one to four times the anti-resonance frequency, and the higher the frequency, the smaller the delay due to damping control. However, the damping effect decreases gradually, so a balanced setting should be chosen.

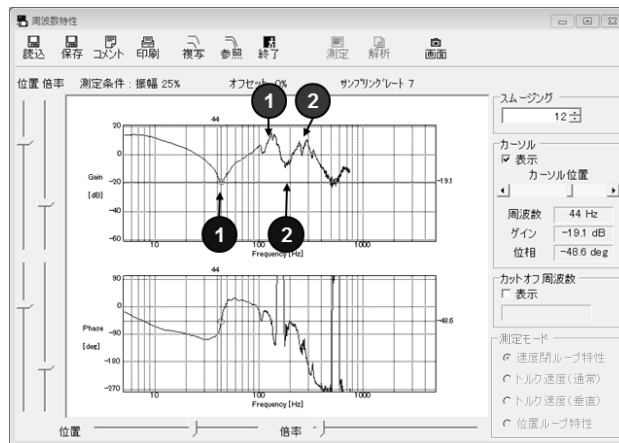

Example of frequency characteristic measurement with setup support software PANATERM

## 5-2-9 Feed forward function

When position control or full closed control is used, positional deviation can be further reduced when compared with deviation where control is made only by feedback, and response is also improved, by calculating the velocity control command necessary for operation based on the internal positional command, and by adding velocity feed forward to the velocity command calculated by comparison with position feedback. In EtherCAT communication, speed feedforward can be set up at 60B1h (Velocity offset) apart from this.

The response time of the velocity control system is also improved by calculating torque command necessary for operation based on the velocity control command and by adding torque feed forward calculated by comparison with velocity feedback to the torque command. In EtherCAT communication, torque feedforward can be set up by 60B2h (Torque offset) apart from this.

The feed forward given through EtherCAT communication is added to the feed forward value (internally calculated according to the parameter setting).

## 1) Relevant parameters

For MINAS-A6B series, the velocity feed forward and torque feed forward can be used.

Class	No.	Attribute *1)	Title	Range	Unit	Function
1	10	B	Velocity feed forward gain	0–4000	0.1%	Multiply the velocity control command calculated according to the internal positional command by the ratio of this parameter and add the result to the velocity command resulting from the positional control process.
1	11	B	Velocity feed forward filter	0–6400	0.01 ms	Set the time constant of 1st delay filter which affects the input of velocity feed forward. *2 It becomes invalid in two-degree-of-freedom control mode.
1	12	B	Torque feed forward gain	0–2000	0.1%	Multiply the torque command calculated according to the velocity control command by the ratio of this parameter and add the result to the torque command resulting from the velocity control process.
1	13	B	Torque feed forward filter	0–6400	0.01 ms	Set up the time constant of 1st delay filter which affects the input of torque feed forward.

\*1) For parameter attribute, refer to Section 9-1.

## 2) Usage example of velocity feed forward

The velocity feed forward will become effective as the velocity feed forward gain is gradually increased with the velocity feed forward filter set at approx. 50 (0.5 ms). The positional deviation during operation at a constant velocity is reduced as shown in the equation below in proportion to the value of velocity feed forward gain.

$$\text{Positional deviation [unit of command]} = \frac{\text{command velocity [unit of command/s]} / \text{positional loop gain [1/s]} \times (100 - \text{velocity feed forward gain [\%]}) / 100$$

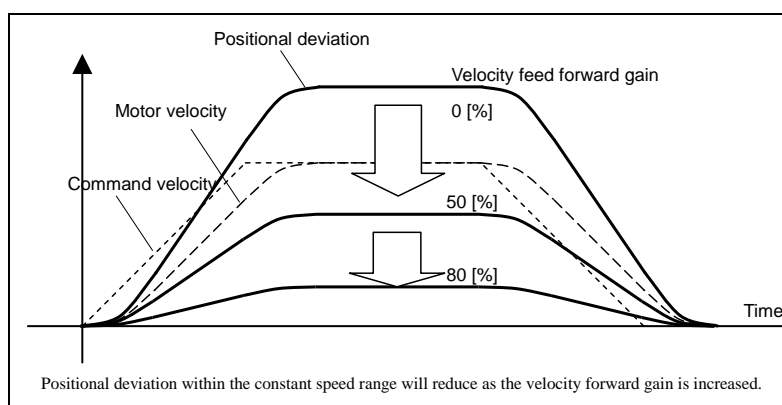

With the gain set at 100%, calculatory positional deviation is 0, but significant overshoot occurs during acceleration/deceleration.

If the updating cycle of the positional command input is longer than the driver control cycle, or the pulse frequency varies, the operating noise may increase while the velocity feed forward is active. If this is the case, use positional command filter (1st delay or FIR smoothing), or increase the velocity forward filter setup value.

3) Usage example of torque feed forward

To use the torque feed forward, correctly set the inertia ratio. Use the value that was determined at the start of the real time auto tuning, or set the inertia ratio that can be calculated from the machine specification to Pr 0.04 Inertia ratio.

The torque feed forward will become effective as the torque feed forward gain is gradually increased with the torque feed forward filter is set at approx. 50 (0.5 ms).

Positional deviation at a constant acceleration/deceleration can be minimized close to 0 by increasing the torque forward gain.

This means that positional deviation can be maintained at near 0 over entire operation range while driving in trapezoidal speed pattern under ideal condition where disturbance torque is not active.

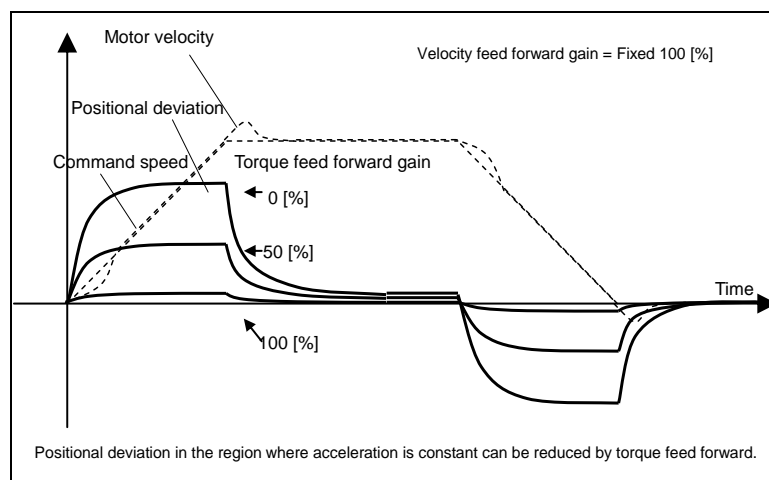

Zero positional deviation is impossible in actual situation because of disturbance torque.

As with the velocity feed forward, large torque feed forward filter time constant decreases the operating noise but increases positional deviation at acceleration change point.

\*If the control mode is changed from other than torque control mode to torque control mode while the motor is in operation, torque feed forward may be applied even if torque control mode.

4) Corresponding control mode

In addition, each feedforward which can setup by EtherCAT communication corresponds to the following control mode.

	csp	pp	ip (Not supported)	hm	csv	pv	cst	tq
60B1h (Velocity offset)	Valid ○	Valid ○	Valid ○	Valid ○	Valid ○	Valid ○	Invalid ×	Invalid ×
60B2h (Torque offset)	Valid ○	Valid ○	Valid ○	Valid ○	Valid ○	Valid ○	Valid ○	Valid ○

## 5-2-10 Load variation suppression function

This function uses the disturbance torque determined by the disturbance observer to reduce effect of disturbance torque and vibration.

This is effective when real-time auto tuning cannot handle load variation sufficiently.

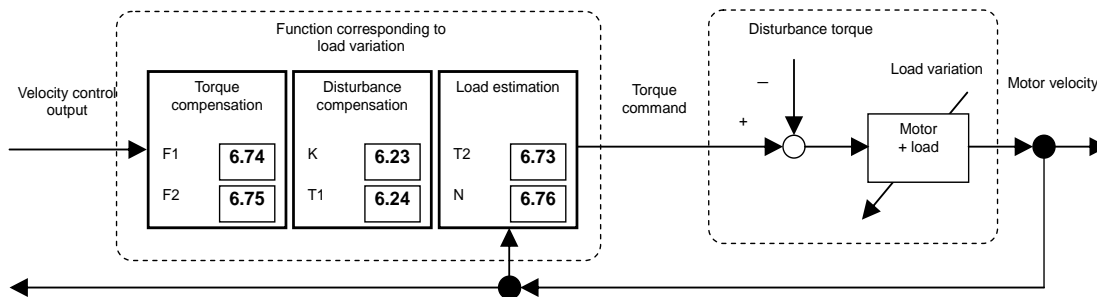

## (1) Applicable Range

- This function can be applicable only when the following conditions are satisfied.

Conditions under which the disturbance observer is activated	
Control model	• Position control, Velocity control or Full-closed control
Others	• Should be in servo-on condition • Parameters except for controls such as torque limit setup, are correctly set, assuring that the motor can run smoothly.

## (2) Caution

- Effect may not be expected in the following condition.

Conditions which obstruct disturbance observer action	
Load	• The rigidity is low (the anti-resonance point is at low frequency range of 10 Hz or below) • The load shows a clear non-linear trend with friction and backlash.

## (3) Relevant parameters

Class	No.	Attribute *1)	Title	Range	Unit	Function
6	10	B	Function expansion setup	-32768–32767	-	Enables or disables the load variation suppression function. bit1 0: Disables the load variation suppression function 1: Enables the load variation suppression function bit2 0: Disables the load variation stabilization setting 1: Enables the load variation stabilization setting bit14 0: Disables the load variation suppression function automatic adjustment 1: Enables the load variation suppression function automatic adjustment * The least significant bit is bit0. * When bit14 to 1, it will be bit1 also 1.
6	23	B	Load change compensation gain	-100–100	%	Defines the compensation gain against load variation.
6	24	B	Load change compensation filter	10–2500	0.01 ms	Defines the filter time constant against load variation.
6	73	B	Load estimation filter	0–2500	0.01 ms	Defines the filter time constant for load estimation.
6	74	B	Torque compensation frequency 1	0–5000	0.1 Hz	Defines the filter frequency 1 against the velocity control output. Torque compensation is enabled when the relation between Pr. 6.74 “Torque compensation frequency 1” and Pr. 6.75 “Torque compensation frequency 2” satisfies the following formula. $1.0 \text{ Hz} \leq \text{Pr. 6.75} \leq \text{Pr. 6.74} \leq (\text{Pr. 6.75} \times 32)$
6	75	B	Torque compensation frequency 2	0–5000	0.1 Hz	Defines the filter frequency 2 against the velocity control output. Torque compensation is enabled when the relation between Pr. 6.74 “Torque compensation frequency 1” and Pr. 6.75 “Torque compensation frequency 2” satisfies the following formula. $1.0 \text{ Hz} \leq \text{Pr. 6.75} \leq \text{Pr. 6.74} \leq (\text{Pr. 6.75} \times 32)$
6	76	B	Load estimation count	0–8	-	Defines the load estimation count.

\*1) For parameter attribute, refer to Section 9-1.

## 4) How to use

There are two methods below for adjusting the load variation suppression function.

■ When there is no load inertia variation (disturbance suppression setting)

< Basic adjustment >

[1] Make normal gain adjustment in advance.

Use real-time auto tuning (Pr. 0.02=1) with the load variation suppression function automatic adjustment disabled (Pr. 6.10 bit14=0), and set stiffness (Pr. 0.03) as high as possible.

[2] Set bit14 to 1 in Pr. 6.10 “Function expansion setup” to enable the load variation suppression function automatic adjustment, and check disturbance suppression effect with the motor rotate.

\* This Pr.6.10 bit1 and 2 it will be 1.

\* Before enabling or disabling the load variation suppression function, turn off the servo first.

\* If this change causes the motor to oscillate or generates an abnormal sound, return to Step [1] and decrease the servo rigidity by one or two levels before repeating the subsequent steps.

< If further adjustment >

[3] Set bit14 to 0 in Pr. 6.10 to disable the automatic adjustment of load variation suppression function.

[4] Specify a small value as possible in Pr. 6.24 “Load change compensation filter”.

Decreasing the filter setup value within the range that does not produce any significant abnormal sound or torque command variation will improve disturbance suppression performance and reduce motor velocity variation and encoder position deviation.

\* When an abnormal sound at high frequency (1 kHz or above) is generated, increase the value in Pr. 6.76 “Load estimation count.”

\* When vibration at low frequency (10 Hz or below) is produced after operation stops, increase the value in Pr. 6.23 “Load change compensation gain”.

\* No change is required for Pr. 6.73 “Load estimation filter” in normal cases, but you can set the optimum point by fine-tuning within the range between around 0.00 and 0.20 ms.

- When there is load inertia variation (load variation stabilization setting) (assumed an articulated robot, etc.)
  - [1] Turn ON the control power in two-degree-of-freedom position control (synchronization type) (Pr. 0.01=0, Pr. 6.47 bit0=1 bit3=1).
  - [2] Set the command response filter (Pr. 2.22) to 10ms.
  - [3] Set real-time auto tuning to load variation support mode, and operate the motor in a pattern as large as possible load variation occurs in this state.
    - \* This Pr6.10 bit1 and 2 it will be 1.
  - [4] Set the stiffness setting (Pr. 0.03) as large as possible.
  - [5] Set the command response filter to appropriate value to continue to decrease while checking response of the motor.  
(\*In case of need to the multi-axis trajectory control, change all axes Pr. 2.22 to the same value and adjust.)



## 5-2-11 3rd gain switching function

In addition to the normal gain switching function described on 5-2-5, 3rd gain switching function can be set to increase the gain just before stopping. The higher gain shortens positioning adjusting time.

## (1) Applicable Range

This function can be applicable only when the following conditions are satisfied.

Conditions under which the 3rd gain switching function is activated	
Control mode	• Position control mode or Full-closed control mode
Others	• Should be in servo-on condition • Parameters except for controls such as torque limit setup, are correctly set, assuring that the motor can run smoothly.

## (2) Relevant Parameters

Class	No.	Attribute *1)	Title	Range	Unit	Function
6	05	B	Position 3rd gain valid time	0-10000	0.1 ms	Set up the time at which 3rd gain becomes valid.
6	06	B	Position 3rd gain scale factor	50-1000	%	Set up the 3rd gain by a multiplying factor of the 1st gain: 3rd gain = 1st gain × Pr 6.06/100

\*1) For parameter attribute, refer to Section 9-1.

## (3) How to use

While in the condition under which the normal gain switching functions, set the 3rd gain application time to Pr 6.05 Position 3rd gain enable time, and set the 3rd gain (scale factor with reference to 1st gain) to Pr 6.06 Position 3rd gain magnification ratio.

- If 3rd gain is not used, set Pr 6.05 to 0 and Pr 6.06 to 100.
- The 3rd gain is enabled only for position control or full closed control(Not supported).
- During the 3rd gain period, only position loop gain/velocity loop gain becomes 3rd gain, during other periods, 1st gain setting is used.
- When the 2nd gain switching condition is established during 3rd gain period, 2nd gain is used.
- During transition from 2nd gain to 3rd gain, Pr 1.19 Position gain switching time is applied.
- Even if the gain is changed from 2nd to the 1st due to parameter change, the 3rd gain period is inserted between them.

Example:

Pr 1.15 Mode of position control switching = 7 switching condition: with positional command:

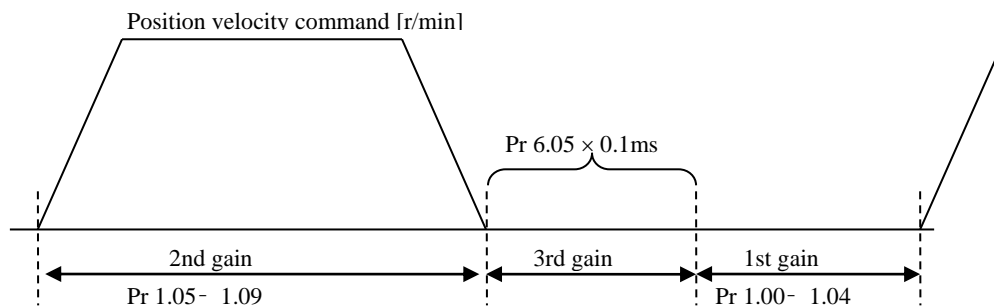

[3rd gain period]

Position loop gain = Pr1.00 × Pr6.06/100

Velocity loop gain = Pr1.01 × Pr6.06/100

Velocity loop integration time constant, velocity detection filter and torque filter time constant directly use the 1st gain value.

## 5-2-12 Friction torque compensation

To reduce effect of friction represented by mechanical system, 3 types of friction torque compensation can be applied:

- offset load compensation that cancels constant offset torque
- The dynamic friction compensation that varies direction as the operating direction varies
- viscous friction torque correction amount that is varied by the command speed

## (1) Applicable Range

This function can be applicable only when the following conditions are satisfied.

Conditions under which the Friction torque compensation is activated	
Control mode	• Specific to individual functions. Refer to “Parameters” shown below.
Others	• Should be in servo-on condition • Parameters except for controls such as torque limit setup, are correctly set, assuring that the motor can run smoothly.

## (2) Relevant Parameters

Combine the following 3 parameters to setup appropriate friction torque compensation.

Class	No.	Attribute *1)	Title	Range	Unit	Function
6	07	B	Torque command additional value	-100–100	%	Set up the offset load compensation value usually added to the torque command in a control mode except for the torque control mode.
6	08	B	Positive direction torque compensation value	-100–100	%	Dynamic friction compensation value to be added to the torque command at the time of position control and full-closed control and when forward direction position command is entered.
6	09	B	Negative direction torque compensation value	-100–100	%	Dynamic friction compensation value to be added to the torque command at the time of position control and full-closed control and when reverse direction position command is entered.
6	50	B	Viscous friction compensating gain	0-10000	0.1% (10000r/min)	When Two-degree-of-freedom control mode is effective, the result multiplying the command speed by this setting is added to the torque command as the viscous friction torque correction amount. By setting the estimated viscous friction coefficient of real-time auto tuning, there are cases in which the feedback scale position deviation in the vicinity of steady state may be improved.

\*1) For parameter attribute, refer to Section 9-1.

## (3) How to use

The friction torque compensation will be added in response to the entered positional command direction as shown below.

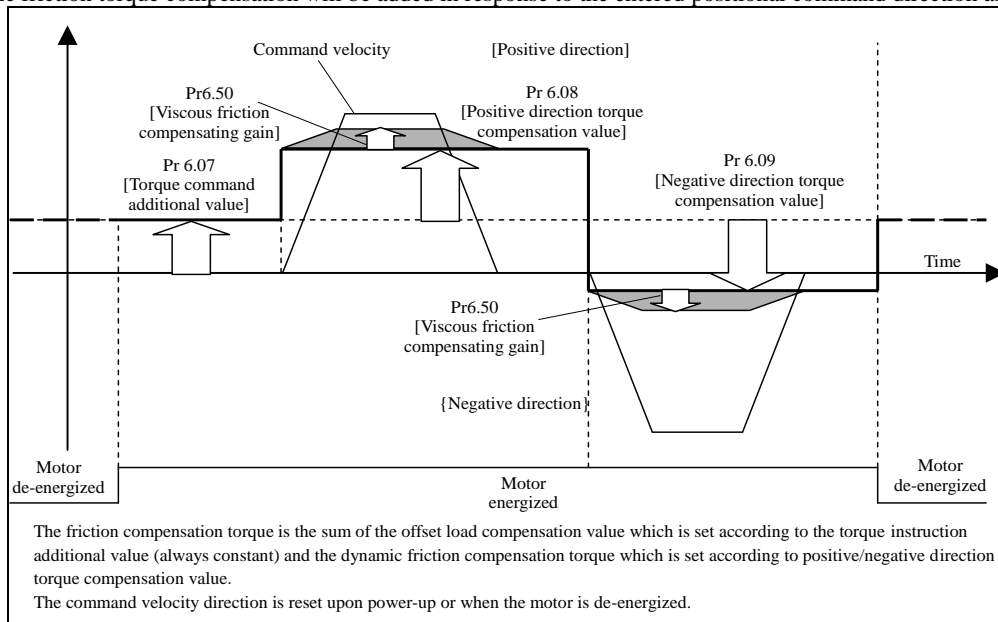

Pr 6.07 [Torque command additional value] reduces variations in positioning operation (performance is affected by direction of movement). These variations occur when constant offset torque resulting from weight on vertical axis is applied to the motor.

Certain loads such as belt driven shaft requires high dynamic friction torque, which lengthens positioning setting time or varies positioning accuracy. These problems can be minimized by setting the friction torque of every rotating direction into individual parameters. Pr 6.08 [Positive direction torque compensation value] and Pr 6.09 [Negative direction torque compensation value] can be used for this purpose.

Pr6.50 “viscous friction compensation gain” reduces response delay at the time of acceleration by setting a torque command value against viscous load. Because of its properties, the compensation is proportional to the speed command value.

The offset load compensation and dynamic friction compensation can be used individually or in combination. However, some control modes impose limit on application.

- For torque control: Offset load compensation and dynamic friction compensation are set at 0 regardless of parameter setting.
- For velocity control with servo-off: Offset load compensation per Pr 6.07 is enabled. Dynamic friction compensation is set at 0 regardless of parameter setting.
- For position control or full closed control(Not supported) with servo-on: Previous offset load compensation and dynamic friction compensation values are maintained until the first positional command is applied where the offset load compensation value is updated according to Pr 6.07. The dynamic friction compensation value is updated to parameters Pr .6.08 and Pr 6.09 depending on command direction.

## 5-2-13 Hybrid vibration damping function

[A6BE]: This function cannot be used.

A function to suppress vibration arising from the twist amount between the motor and the load in the Full-closed control mode. This function enables high setting of gains.

## (1) Applicable Range

This function is unable to be applied unless the following conditions are satisfied.

Conditions in which hybrid vibration suppression functions are activated.	
Control mode	• Full-closed control mode
Miscellaneous	• To be in the servo ON state. • Parameters except for controls such as torque limit setup, are correctly set, assuring that the motor can run smoothly.

## (2) Caution

- This function is effective when the twist amount between the motor shaft and the load is great. When the twist amount is small, there are cases in which the effect may be small.

## (3) Relevant Parameters

Combining the following parameters, hybrid vibration suppression function is set.

Class	No.	Attribute *1)	Title	Range	Unit	Function
6	34	B	Hybrid vibration suppression gain	0-30000	0.1/s	Set hybrid vibration suppression gain. Basically, set the same value as the position loop gain and finely adjust while monitoring the conditions.
6	35	B	Hybrid vibration suppression filter	0-32000	0.01 ms	Set the hybrid vibration suppression filter.

\*1) For parameter attribute, refer to Section 9-1.

## (4) How to use

- [1] Set Pr6.34 “Hybrid vibration suppression gain” to be same as the position loop gain.
- [2] While driving in the full-closed control, increase the setting of Pr6.35 “hybrid vibration suppression filter” gradually and check changes of response.  
If response seems to be improved, while adjusting Pr6.34 and Pr6.35, find a combination that can achieve the optimum response.

## 5-2-14 Two-stage torque filter

In addition to usual 1st and 2nd torque filters (Pr1.04 and Pr1.09), another torque filter can be set. High-frequency vibration component can be suppressed by the use of the 2-stage torque filter.

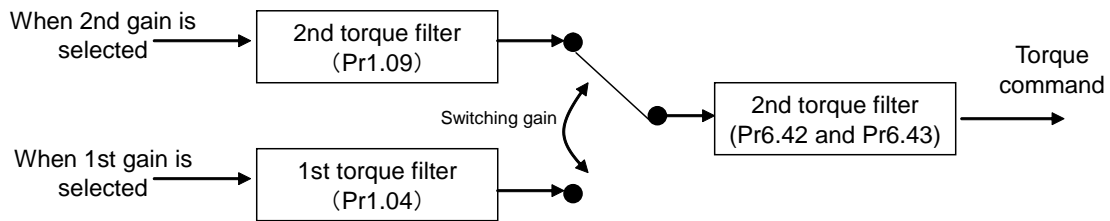

## (1) Application Range

This function can't be applied unless the following conditions are satisfied.

Conditions for operating 2-stage torque filter	
Control mode	• Can be used in all control modes.
Others	• In servo-ON state • Elements, such as deviation counter clear command input inhibition and torque limit, other than control parameter are set properly, and motor is running without any problem.

## (2) Caution

- If the setting value is increased excessively, the control may become unstable to produce vibration. Specify proper setting value while checking the status of the device.
- If Pr6.43 "2-stage torque filter attenuation term" is changed during operation, vibration may be generated. Change the value while the motor is stopped.

## (3) Relevant Parameters

Class	No.	Attribute *1)	Title	Range	Unit	Function
6	42	B	2-stage torque filter time constant	0–2500	0.01ms	Sets 2-stage torque filter time constant. The time constant is invalid if 0 is specified. [When used for the secondary filter as Pr6.43 ≥ 50] The time constants that can be used are 4–159 (0.04–1.59 ms). (Equivalent to 100–4000 Hz in frequency) Setting values 1–3 works as 4 (4000 Hz), and 159–2500 works as 159 (100 Hz).
6	43	B	2-stage torque filter attenuation term	0–1000	—	Sets attenuation term of 2-stage torque filter. The filter degree of the 2-stage torque filter is changed according to the setting value. 0–49: Operates as the 1st filter. 50–1000: Operates as a 2nd filter and becomes a 2nd filter with $\zeta = 1.0$ if setting value is 1000. As the setting value is decreased, the filter becomes vibrational. Use with a setting value 1000 basically.

\*1) For parameter attribute, refer to Section 9-1.

## (4) How to use

Set a 2-stage torque filter if high-frequency vibration can't be removed only using usual 1st and 2nd torque filters. Setting Pr6.43 "2-stage torque filter attenuation term" to 1000 ( $\zeta = 1.0$ ), adjust Pr6.42 "2-stage torque filter time constant".

## 5-2-15 Quadrant projection suppression function

Control configuration can be switched to suppress quadrant projection occurring during arc interpolation of 2 or more axes. To be used in conjunction with load fluctuation suppression function.

## (1) Applicable Range

- This function is unable to be applied unless the following conditions are satisfied:

Conditions in which quadrant projection suppression function is triggered	
Control mode	<ul style="list-style-type: none"> <li>Position control mode or Full-closed control mode.</li> </ul>
Others	<ul style="list-style-type: none"> <li>To be in Servo-On state.</li> <li>Elements other than control parameters, such as prohibition of deviation counter clear command input and torque limit, etc. are set appropriately, in a state where there are no obstructions in normal motor revolutions.</li> </ul>

## (2) Caution

- There are cases where effects cannot be observed under the following conditions:

Conditions where the effects of quadrant projection suppression function is disrupted	
Load	<ul style="list-style-type: none"> <li>When rigidity is low (anti-resonance point exists in the low frequency range of 10 Hz or lower)</li> <li>When non-linearity of load is strong from existence of backlash, etc.</li> <li>When action patterns are changed.</li> </ul>

## (3) Related Parameters

Class	No.	Attribute *1)	Title	Range	Unit	Function
5	45	B	Quadrant glitch positive-direction compensation value	-1000–1000	0.1%	Sets amount of compensation to be added to torque command when the position command is in positive direction and quadrant projection compensation function is enabled.
5	46	B	Quadrant glitch negative-direction compensation value	-1000–1000	0.1%	Sets amount of compensation to be added to torque command when the position command is in negative direction and quadrant projection compensation function is enabled.
5	47	B	Quadrant glitch compensation delay time	0–1000	ms	Sets the length of delay time for switching of amount of compensation after position command has been reversed, when quadrant projection compensation function is enabled.
5	48	B	Quadrant glitch compensation filter setting L	0–6400	0.01 ms	Sets time constant for low-pass filter on the amount of compensation on torque command when quadrant projection compensation function is enabled.
5	49	B	Quadrant glitch compensation filter setting H	0–10000	0.1 ms	Sets time constant for high-pass filter on the amount of compensation on torque command when quadrant projection compensation function is enabled.
6	47	R	Function expansion setup 2	-32768–32767	–	bit14: Enables/disables quadrant projection compensation function. 0: disabled, 1: enabled
6	97	B	Function expansion setup 3	-2147483648–2147483647	–	bit0: Enables/disables quadrant projection compensation function extended. 0: disabled, 1: enabled * To set the compensation amount of quadrant projection by inversion direction when the direction of the velocity has changed, set Pr6.97 bit0 to 1.

\*1) For parameter attribute, refer to Section 9-1.

## (4) How to use

Adjust the load change inhibit function using the disturbance suppression setup by reference to Section 5-2-10, and measure quadrant projection.

Level is unsatisfactory, conduct further fine adjustment using quadrant projection suppression function.

[1] Reclose control power supply after enabling quadrant projection suppression function (Pr 6.47 bit14 = 1)

[2] Set initial values to: Pr 5.47 = 0, Pr 5.48 = Pr 1.04, Pr 5.49 = 0.

[3] Measure the magnitude of quadrant projection and conduct fine adjustments to Pr 5.45 and Pr 5.46 of each axis.

\* When quadrant projection is delayed from the timing of the movement direction is reversed, try changing Pr 5.47 and Pr 5.48.

\* To set the compensation amount of quadrant projection by inversion direction when the direction of the velocity has changed, set Pr6.97 bit0 to 1 and try change Pr5.49.

## 5-2-16 Two-degree-of-freedom control mode (with position control)

The two-degree-of-freedom control mode is an expanded function of the position control switching mode. Responsiveness is improved by making it possible to set the positional command response and servo stiffness independently.

Either of the standard type or synchronization type of the two-degree-of-freedom control can be used.

## (1) Applicable Range

This function cannot be applied unless the following conditions are satisfied.

Operating conditions for the two-degree-of-freedom control mode	
Control mode	• Position control mode (semi-close control)
Other	• The servo is ON. • Elements other than control parameters such as torque limit are set properly, and there is no obstacle to normal motor operation.

## (2) Related Parameters

First, set Pr6.47 “Function expansion setup 2” to bit0=1 and write the setting to EEPROM, and then reset the control power to enable two-degree-of-freedom control.

After this, make adjustments of the real-time auto-tuning function (refer to Section 5-1-3 or 5-1-4).

Only when further improvement is required, manually fine-tune the following parameters while confirming the response.

Class	No.	Attribute *1)	Title	Range	Unit	Function
6	47	R	Function expansion setup 2	-32768– 32767	–	Set respective functions in unit of bit. bit0 two-degree-of-freedom control mode 0: Invalid      1: Valid bit3 Selection of real-time auto-tuning of two-degree-of-freedom control 0: Standard type      1: Synchronization type * The least significant bit is bit0. * bit3 (Selection of real-time auto-tuning of two-degree-of-freedom control) can be used only when bit0 is set to 1: Valid.
2	22	B	Command smoothing filter	0–10000	0.1ms	Time constant for the command filter is set in two-degree-of-freedom control. • The maximum value is limited to 2000 (=200.0 ms). *The parameter value itself is not limited, but the value applied in the driver is limited. • Command response can be quickened by decreasing this parameter and slowed by increasing it. • The attenuation term is set by Pr6.49 “Adjust/Torque command attenuation term”.
6	48	B	Adjust filter	0–2000	0.1ms	Set the time constant for the adjust filter. • When the torque filter setting has been changed, set a value close to the real-time auto-tuning setting. • As a result of fine-tuning while checking the encoder position deviation near the setting, overshoot and oscillatory waveforms may be improved. • The attenuation term is set by Pr6.49 “Adjust/Torque command attenuation term”.

(To be continued)

Class	No.	Attribute *1)	Title	Range	Unit	Function
6	49	B	Command / tuning filter damping	0-99	-	<p>Set the attenuation term for the command filter and adjust filter.</p> <ul style="list-style-type: none"> <li>A decimal number indication is used. The first digit sets the command filter and the second digit sets the adjust filter.</li> </ul> <p>&lt;Each target digit of the set value&gt;            0 to 4: No attenuation term (operated as primary filter)            5 to 9: Secondary filter (Attenuation terms, <math>\zeta</math> will be 1.0, 0.86, 0.71, 0.50, and 0.35 in order.)</p> <p>&lt;Setting an example of this parameter&gt;            To set the command filter to <math>\zeta=1.0</math> and adjust filter 1 to <math>\zeta=0.71</math>, the setting value should be 75 (first digit=5 (<math>\zeta=1.0</math>), second digit=7 (<math>\zeta=0.71</math>)).            For the time constant of the command filter, Pr2.22 "Command smoothing filter" will be applied.</p>
6	50	B	Viscous friction compensation gain	0-10000	0.1% / (10000r/min)	<p>Add the result of multiplying the command velocity by this setting value to the torque command as the correction amount of the viscous friction torque.</p> <ul style="list-style-type: none"> <li>The encoder position deviation near the setting may be improved by setting the viscous friction factor estimation for real-time auto-tuning.</li> </ul>

\*1) For the parameter attributes, refer to Section 9-1.



(3) Two-degree-of-freedom control mode (with position control)

The mode of 2 degrees of freedom control is configured as shown in the block diagram below.

 Monitor data for PANATERM

 Monitor data for CiA402 object

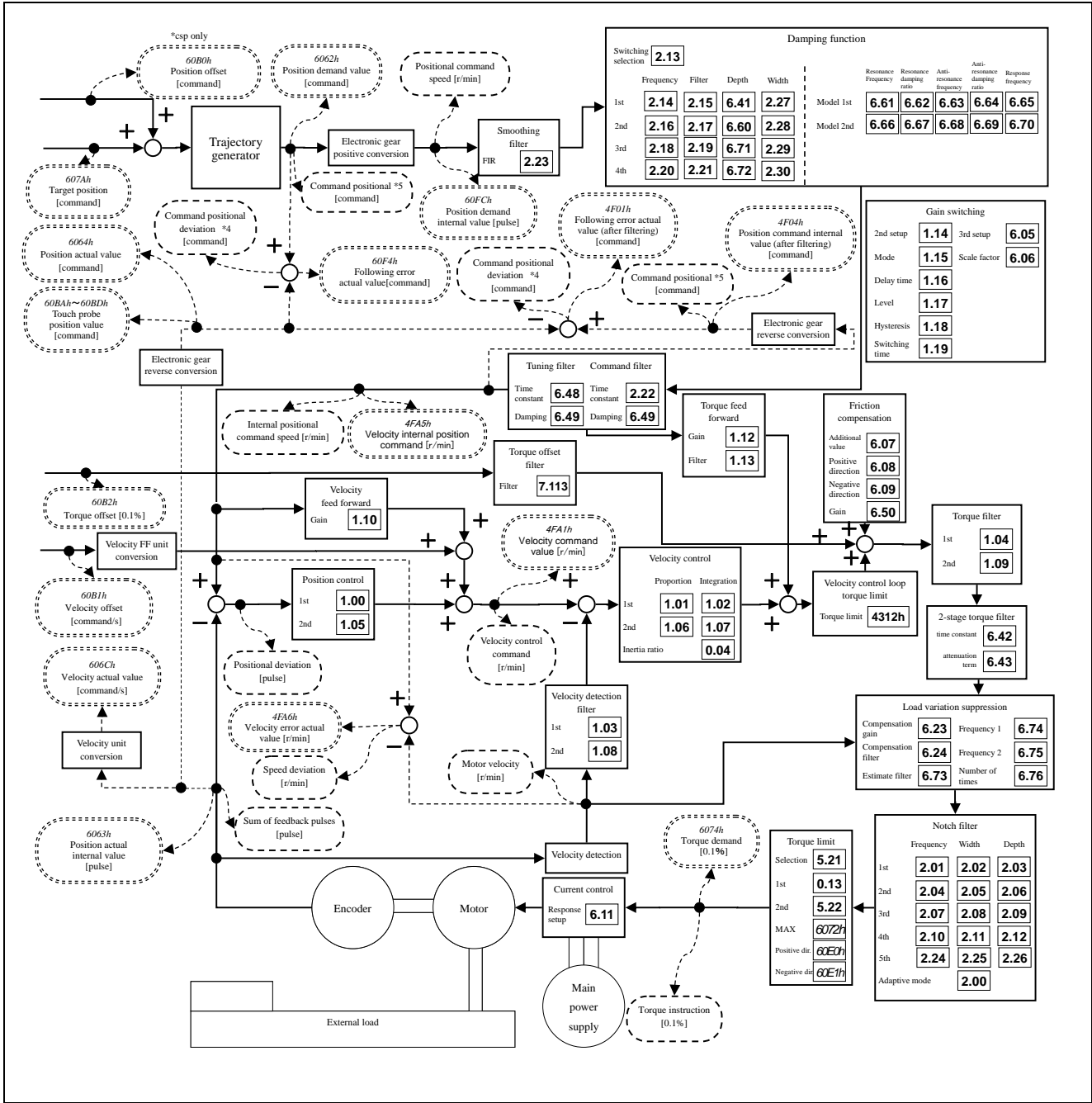

Two-degree-of-freedom control mode (with position control) block diagram

- \*1) A slanting number shows (ex: 607Ah) the object number of EtherCAT.
- \*2) A bold letter number shows (ex: **1.00**) a parameter number.
- \*3) Polarity was omitted.
- \*4) The method to calculate the positional deviation on PANATERM (standard) varies depending on the setting of the command positional deviation output change (bit 14) of Pr 7.23 (Communication function extended setup 2).
- \*5) The position command on PANATERM can be switched depending on the setting of bit3 (Command pulse accumulation value) of Pr7.99(Communication function extended setup 6).
- \*6) When performing test run function, Z phase search, Frequency characteristic measurement (position loop characteristic) from the PANATERM, the driver switches to position control mode internally.
- \*7) Pr7.113 (Torque offset filter) , 4312h (Velocity control loop torque limit) and 60E0h/60E1h (Positive/Negative torque limit value) are not supported in function extended edition 2 and earlier versions.

## 5-2-17 Two-degree-of-freedom control mode (with velocity control)

The two-degree-of-freedom control mode is an extended function of velocity control mode to improve the responsiveness by making it possible to independently set the command response and servo rigidity. Only the standard type of two-degree-of-freedom control is available.

## (1) Applicable Range

This function is unable to be applied unless the following conditions are satisfied.

Conditions in which two-degree-of-freedom control mode is activated.	
Control mode	• Velocity control
Miscellaneous	<ul style="list-style-type: none"> <li>• Real-time auto tuning selection is two-degree-of-freedom control mode standard type. (Note) In the case of the Synchronization s type, Err88.1“Control mode setting error protection” occurs.</li> <li>• To be in the servo ON state.</li> <li>• Elements other than control parameters, such as torque limit, etc. are properly set and the motor is free of obstacle to normal motor rotation.</li> </ul>

## (2) Related Parameters

First of all, set Pr6.47 “Function expansion setup 2”:bit0 to 1 and write in EEPROM; then, reset the control power supply to enable the two-degree-of-freedom control mode.

Thereafter, adjust the related parameters by real-time auto-tuning (see 5-1-3). Only when further improvement is required, manually finely adjust the following parameters while confirming responses.

Class	No.	Attribute *1)	Parameter name	Setting range	unit	Functions
6	47	R	Function expansion setup 2	-32767–32768	-	<p>Various functions are set in bit units.</p> <p>bit0 Two-degree-of-freedom mode 0: Invalid 1: Valid</p> <p>bit3 Selection of real-time auto-tuning of two-degree-of-freedom control 0: Standard type 1: Synchronization type</p> <p>*The least significant bit is set to bit0.</p>
2	22	B	Command smoothing filter	0–10000	0.1 ms	<p>At the time of the two-degree-of-freedom control, the time constant of command response filter is used.</p> <ul style="list-style-type: none"> <li>• The maximum value is restricted to 640 (=64.0 ms).</li> <li>*The parameter value itself is not restricted but the applied value inside the driver is restricted.</li> <li>• Making this parameter smaller can quicken the command response, whereas making it larger can slow the command response.</li> </ul>
6	48	B	Adjust filter	0–2000	0.1 ms	<p>To set the time constant of adjustment filter.</p> <ul style="list-style-type: none"> <li>• When the torque filter setting is changed, set the adjustment filter to a near value while referring to setting of real-time auto-tuning.</li> <li>• At the time of speed control mode, The maximum value is restricted to 640 (=64.0 ms).</li> <li>*The parameter value itself is not restricted but the applied value inside the driver is restricted.</li> </ul>

\*1) For the parameter attributes, refer to Section 9-1.

(3) Block diagram of the two-degrees-of-freedom control mode(with velocity control)

Two-degree-of-freedom control mode (with velocity control) shall be as per the block diagram indicated below.

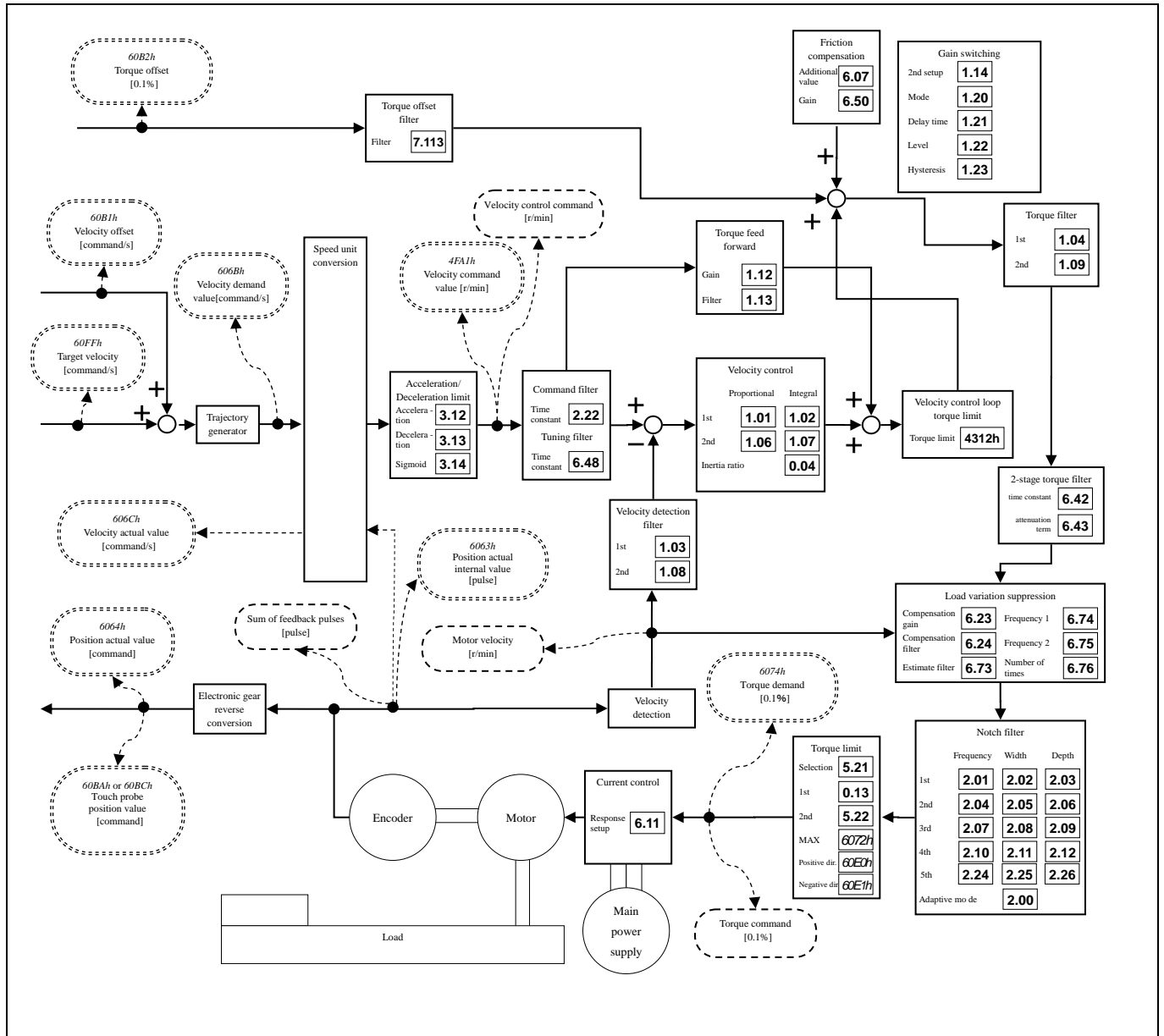
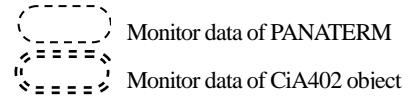

Two-degree-of-freedom control mode (with velocity control) block diagram

- \*1) A slanting number shows (ex: 607Ah) the object number of EtherCAT.
- \*2) A bold letter number shows (ex: **1.00**) a parameter number.
- \*3) Polarity was omitted.
- \*4) When performing Frequency characteristic measurement (speed close loop characteristic, Torque speed (Vertical)) from the PANATERM, the driver switches to velocity control mode internally.
- \*5) Pr7.113 (Torque offset filter) , 4312h (Velocity control loop torque limit) and 60E0h/60E1h (Positive/Negative torque limit value) are not supported in function extended edition 2 and earlier versions.

## 5-2-18 Two-degree-of-freedom control mode (with Full-closed control)

The two degree-of-freedom control mode is an extended function of Full-closed control mode to improve the responsiveness by making it possible to independently set the command response and servo rigidity.

Only the standard type of two-degree -of-freedom control is available.

## (1) Applicable Range

- This function is unable to be applied unless the following conditions are satisfied:

Conditions in which two-degree-of-freedom control mode is activated	
Control mode	• Full-closed control
Miscellaneous	• Real-time auto tuning selection is two-degree-of-freedom control mode standard type. (Note) In the case of the Synchronization s type, Err88.1“Control mode setting error protection” occurs. • To be in the servo ON state. • Elements other than control parameters, such as torque limit, etc. are properly set and the motor is free of obstacle to normal motor rotation.

## (2) Related Parameters

First of all, with Pr6.47 write “Function expansion setup 2” bit0 = 1 into EEPROM, and then, make the two degree-of-freedom control mode enabled by resetting the control power supply.

Thereafter, adjust by the real-time auto-tuning (refer to 5-1-3). Only when further improvement is required, finely adjust the following parameters manually while checking the responses.

Class	No.	Attribute *1)	Title	Range	Unit	Function
6	47	R	Function expansion setup 2	-32768–32767	–	Set respective functions in unit of bit. bit0 two-degree-of-freedom control mode 0: Invalid 1: Valid bit3 Selection of real-time auto-tuning of two-degree-of-freedom control 0: Standard type 1: Synchronization type * The least significant bit is bit0. * bit3 (Selection of real-time auto-tuning of two-degree-of-freedom control) can be used only when bit0 is set to 1: Valid.
2	22	B	Command smoothing filter	0–10000	0.1ms	Time constant for the command filter is set in two-degree-of-freedom control. • The maximum value is limited to 2000 (=200.0 ms). *The parameter value itself is not limited, but the value applied in the driver is limited. • Command response can be quickened by decreasing this parameter and slowed by increasing it. • The attenuation term is set by Pr6.49 “Adjust/Torque command attenuation term”.
6	48	B	Adjust filter	0–2000	0.1ms	Set the time constant for the adjust filter. • When the torque filter setting has been changed, set a value close to the real-time auto-tuning setting. • As a result of fine-tuning while checking the encoder position deviation near the setting, overshoot and oscillatory waveforms may be improved. • The attenuation term is set by Pr6.49 “Adjust/Torque command attenuation term”.

(to be continued)

Class	No.	Attribute *1)	Title	Range	Unit	Function
6	49	B	Command / tuning filter damping	0-99	-	<p>Set the attenuation term for the command filter and adjust filter.</p> <ul style="list-style-type: none"> <li>A decimal number indication is used. The first digit sets the command filter and the second digit sets the adjust filter.</li> </ul> <p>&lt;Each target digit of the set value&gt;            0 to 4: No attenuation term (operated as primary filter)            5 to 9: Secondary filter (Attenuation terms, <math>\zeta</math> will be 1.0, 0.86, 0.71, 0.50, and 0.35 in order.)</p> <p>&lt;Setting an example of this parameter&gt;            To set the command filter to <math>\zeta=1.0</math> and adjust filter 1 to <math>\zeta=0.71</math>, the setting value should be 75 (first digit=5 (<math>\zeta=1.0</math>), second digit=7 (<math>\zeta=0.71</math>)).            For the time constant of the command filter, Pr2.22 "Command smoothing filter" will be applied.</p>
6	50	B	Viscous friction compensation gain	0-10000	0.1% / (10000r/min)	<p>Add the result of multiplying the command velocity by this setting value to the torque command as the correction amount of the viscous friction torque.</p> <ul style="list-style-type: none"> <li>The encoder position deviation near the setting may be improved by setting the viscous friction factor estimation for real-time auto-tuning.</li> </ul>

\*1) For the parameter attributes, refer to Section 9-1.

[A6BE]: This function cannot be used.

(3) Block diagram of the two-degrees-of-freedom control mode (with Full-closed control)

Two-degree-of-freedom control mode (with Full-closed control) shall be as per the block diagram indicated below.

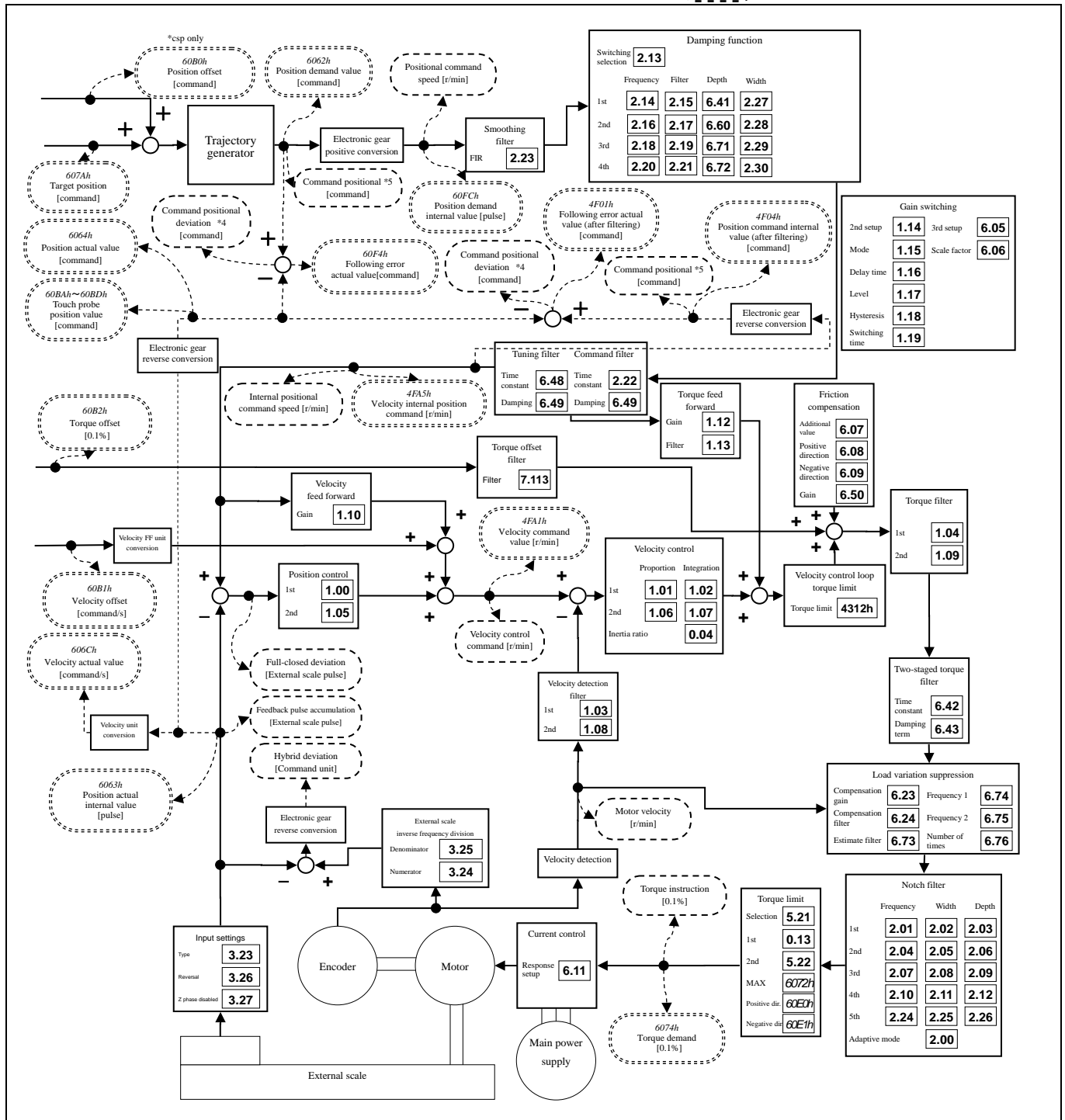
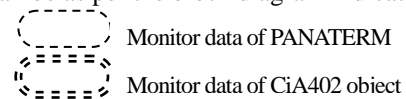

Two-degree-of-freedom control mode (with full-closed control) block diagram

- \*1) A slanting number shows (ex: 607Ah) the object number of EtherCAT.
- \*2) A bold letter number shows (ex:1.00) a parameter number.
- \*3) Polarity was omitted.
- \*4) The method to calculate the positional deviation on PANATERM (standard) varies depending on the setting of bit14 (command positional deviation output change) of Pr7.23 (Communication function extended setup 2).
- \*5) The position command on PANATERM can be switched depending on the setting of the bit3 (Command pulse accumulation value) of Pr7.99 (Communication function extended setup 6).
- \*6) Pr7.113 (Torque offset filter) , 4312h (Velocity control loop torque limit) and 60E0h/60E1h (Positive/Negative torque limit value) are not supported in function extended edition 2 and earlier versions.

## 5-2-19 Two-degree-of-freedom control mode (with torque control)

Two-degree-of-freedom control mode has an equivalent configuration to torque control with two-degree-of-freedom control invalid.

For details, refer to EtherCAT Communication Specification (SX-DSV03242), Section 6-8 “Torque control function (tq.cst).”

\*1 Torque control under two-degrees-of-freedom control mode executes a similar control as torque control under the conventional control mode.

\* Err88.1 “Control mode setting error protection” occurs when it is switched to torque control under two-degrees-of-freedom control mode(standard type) in function extended version 2 and earlier versions.

\* Err88.1 “Control mode setting error protection” occurs when it is switched to torque control under two-degrees-of-freedom control mode(synchronization type) in function extended version 4 and earlier versions.

## 5-2-20 High response current control

High response current control is a function to improve the responsiveness of the current control part by changing Pr6.11 “Current response setup” to a value larger than the shipment value 100%.

Because it may be prone to generate vibration and noise, adjust to an appropriate value depending on the operating situation of an applicable unit just like the adjustment of the position control part/velocity control part.

## (1) Applicable Range

- This function works under the following condition.

Operating conditions for high response current control	
Control mode	• Can be used in all control modes.
Miscellaneous	• The software version shall be function extended version 2 or later. • Should be in servo-on condition • The elements other than control parameters such as torque limit settings are correctly set, assuring that the motor can run smoothly.

## (2) Related Parameters

Class	No.	Attribute *1)	Title	Range	Unit	Function
6	11	B	Current response setup	10~300	%	Adjust the current response with the level at shipment considered as 100%. Setting this setting value at a value larger than 100 can improve current responsiveness. (Note) The setting range is 10 to 100% for function extended edition 2 or earlier.

## (3) Caution

- Also in the function extended edition 3 and later versions, when Pr6.11 “Current response setup” value is 99 or smaller, it is possible to make current responsiveness lower than that at shipment as before.
- The settable maximum value differs depending on the connected motor and the value is limited to 300% or lower (100% for some motors).



## 6. Application

### 6-1 Torque limit switching function

It is a function which changes a torque limit value by the direction of operation.

#### (1) Applicable Range

□ This function can be applicable only when the following conditions are satisfied.

Conditions under which the Torque limit switching function is activated	
Control mode	• Position control mode, Velocity control mode, Full-closed control mode and Torque control mode *1)
Others	• Should be in servo-on condition • Parameters except for controls are correctly set, assuring that the motor can run smoothly.

\*1) Settings other than Pr5.21=5 will be disabled during torque control, and Pr0.13 “1st torque limit” becomes enabled.

#### (2) Relevant Parameters

Class	No.	Attribute *1)	Title	Range	Unit	Function																		
0	13	B	1st torque limit	0-500	%	You can set up the 1st limit value of the motor output torque.																		
5	21	B	Selection of torque limit	0-5	—	<p>You can set up the torque limiting method.</p> <table border="1"> <thead> <tr> <th>Setup value</th> <th>Negative direction</th> <th>Positive direction</th> </tr> </thead> <tbody> <tr> <td>1</td> <td colspan="2">Pr0.13</td> </tr> <tr> <td>2</td> <td>Pr5.22</td> <td>Pr0.13</td> </tr> <tr> <td>3</td> <td colspan="2">Pr0.13</td> </tr> <tr> <td>4</td> <td>Pr5.22</td> <td>Pr0.13</td> </tr> <tr> <td>5</td> <td>60E1h</td> <td>60E0h</td> </tr> </tbody> </table> <p>*If 0 is set for this parameter, 1 is internally set. • Only the setting Pr5.21=5 becomes enabled during torque control. When Pr5.21=1 to 4, Pr0.13 is applied to the torque limit. (Note) The setting range is 0 to 4 in software version of function extended edition 3 and earlier versions.</p>	Setup value	Negative direction	Positive direction	1	Pr0.13		2	Pr5.22	Pr0.13	3	Pr0.13		4	Pr5.22	Pr0.13	5	60E1h	60E0h
Setup value	Negative direction	Positive direction																						
1	Pr0.13																							
2	Pr5.22	Pr0.13																						
3	Pr0.13																							
4	Pr5.22	Pr0.13																						
5	60E1h	60E0h																						
5	22	B	2nd torque limit	0-500	%	You can set up the 2nd limit value of the motor output torque.																		

\*1) For parameter attribute, refer to Section 9-1.

#### (3) Related object

Index	Sub-Index	Name / Description	Units	Range	Data Type	Access	PDO	Op-mode	EEPROM
6072h	00h	Max torque • Set the maximum torque. If the value exceeds the maximum torque of the motor is limited by the maximum torque of the motor. Note: The maximum torque of the motor varies depending on the motor applied.	0.1%	0 – 65535	U16	rw	Yes	ALL	Yes

Torque command is limited at smaller one of 6072h and those effective for Pr0.13 and Pr5.22.

## 6-2 Motor working range setup function

If the motor with respect to the position command input range exceeds the motor operating range that is set by Pr5.14“Motor working range setup”, it can be alarm stop at the Err34.0 “motor movable range set protection”.

The allowable motor operating range is calculated internally by the servo driver under the following formula:

- Positive direction allowable motor operating range = Positive direction position command entry input range + Pr5.14
- Negative direction allowable motor operating range = Negative direction position command entry input range - Pr5.14

In case the actual motor position for judgment exceeds this range, Err34.0 “motor movable range set protection” will be detected.

## (1) Applicable Range

□ This function can be applicable only when the following conditions are satisfied.

Conditions under which the software limit works	
Control mode	• Position control mode and Full-closed control mode.
Others	• Should be in servo-on condition • Parameters except for controls such as torque limit setup, are correctly set, assuring that the motor can run smoothly.

## (2) Caution

- This function is not a protection against the abnormal position command.
- When this software limit protection is activated, the motor decelerates and stops according to 605Eh(Fault reaction option code).  
The work (load) may collide to the machine end and be damaged depending on the load during this deceleration, hence set up the range of Pr 5.14 including the deceleration movement.
- When changing the control mode (for the purpose of only to control velocity or torque), do not use this function. Instead, use software limit function or drive inhibit input.
- When any of the following values ([encoder pulse] or [external scale pulse]) managed internally in the servo driver, exceeds  $-2^{31}$  to  $2^{31}-1$ , Err34.0 “motor movable range set protection” detection process will be invalidated’ .\*1
  - Position command input range
  - Actual motor position for judgment
  - Motor movable range
- In case any of the following conditions are satisfied, the position command input range and the actual motor position for judgment managed inside the servo driver will be cleared and Err34.0 “Motor movable range setting error protection” detection process will be invalidated.
  - When the control power is turned on
  - Servo-OFF state
  - Velocity control state or torque control state
  - During frequency response measurement using setup support software (PANATERM).
  - During the time position deviation is cleared (When an EMS state transitions from Init to PreOP, decelerated stop from alarm, etc.).
  - When position information is initialized
  - When absolute clear by Setup support software (PANATERM) etc.
    - Pr5.14 = 0
    - In Full-closed control mode,when Pr5.14 satisfies the following formula (when the value of Pr5.14 converted into external pulse units exceeds  $2^{31}-1$ ). \*1
 
$$\text{Pr5.14} > ((2^{31} - 1) * \text{Pr3.24} * 10) / (\text{Encoder resolution} * \text{Pr3.25})$$
    - When clearing position deviation during deceleration to stop due to over-travel inhibit input
    - When returning to home

\*1) However, when Err34.0 detection processing is invalid, Err34.0 can be generated by setting the following setting to valid.

Pr6.97 “Function expansion setup 3”

bit2 Expansion of Allowable motor operating range abnormal protection 0: Invalid, 1: Valid

## (3) Relevant Parameters

Class	No.	Attribute *1)	Title	Range	Unit	Function
5	14	A	Motor working range setup	0-1000	0.1 revolution	You can set up the movable range of the motor against the position command input range. When the motor movement exceeds the setup value, software limit protection will be triggered. When set value of this parameter is 0, Err34.0 become disable. Also in conditions written in above (2) Caution, Err34.0 become disable.
6	97	B	Function expansion setup 3	-2147483648 - 2147483647	-	Sets various function in bit units: bit 2: Expansion of Allowable motor operating range abnormal protection 0: Invalid, 1: valid

\*1) For parameter attribute, refer to Section 9-1.

## (4) Operation example

## (1) When no position command is entered (Servo-ON status)

The motor movable range will be the travel range which is set at both sides of the motor with Pr5.14 since no position command is entered. When the load enters to the Err34.0 occurrence range (oblique line range), software limit protection will be activated.

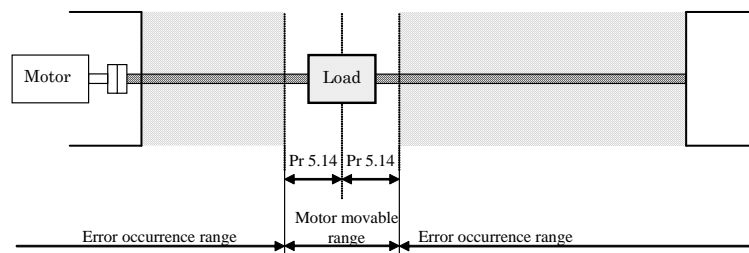

## (2) When the load moves to the right (at Servo-ON)

When the position command to the right direction is entered, the motor movable range will be expanded by entered position command, and the movable range will be the position command input range + Pr5.14 setups in both sides.

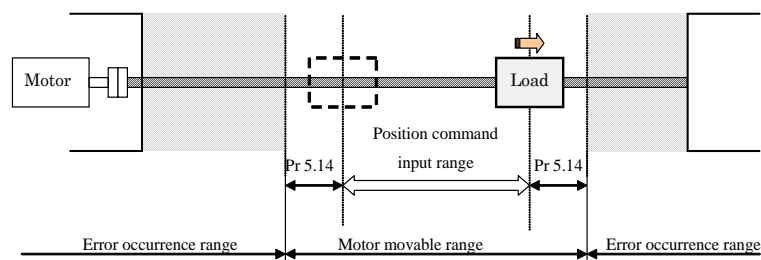

## (3) When the load moves to the left (at Servo-ON)

When the position command to the left direction, the position command input range will be expanded further.

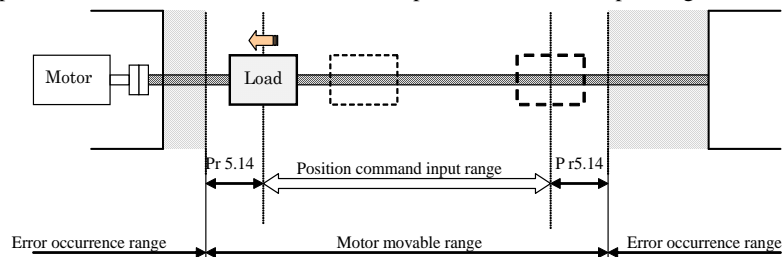

## 6-3 Deceleration stop sequence

Sets how to decelerate and stop the motor if main power is shut down or an alarm occurs while PDS is Operation enabled state (servo-on state).

Combine the deceleration function (option code) defined by CoE(CiA402) and the deceleration function on the servo (MINAS-A6) side (dynamic brake stop, free-run stop, emergency stop).

Change the deceleration setting from the shipment value according to the equipment environment.

For each parameter and the shipment values of the EtherCAT objects, refer to the Standard specifications.

Please refer to section 6-9-2 "Option Code (deceleration stop sequence)" of Technical Document "EtherCAT Communication Specifications" (SX-DSV03242) for details.

## 6-3-1 Sequence upon inputting of over-travel inhibition (POT, NOT)

Set up the operating sequence when the over-travel inhibition is input (POT, NOT).

In hm mode, there are following 2 modes: the mode for performing the reverse motion after stopping in accordance with the Method that is specified and the mode in which the edge of POT/NOT is set as the home position. For details, refer to Technical Reference, SX-DSV03242" Section 6-6-5 "Homing Position Control Mode (hm mode)", EtherCAT communication specification.

The over-travel inhibition state can be notified as a warning.

For details, refer to 7-3 "Details of Protective Function" and 3-6-1 "Message at Error Occurrence" in EtherCAT Communication Specification (SX-DSV03242).

Note) Set the over-travel inhibition input (POT, NOT) correctly.

- If it is set incorrectly (NOT for the drive side in the positive direction, POT for the drive side in the negative direction, etc.), operations cannot be guaranteed.
- Install it in a position that takes into account the amount of movement before decelerating and stopping.  
Note that if the torque limit or deceleration setting value is small, the amount of movement before decelerating and stopping may increase.

## (1) Relevant parameters

Class	No.	Attribute *1)	Title	Range	Unit	Function
5	04 *2)	C	Over-travel inhibit input setup	0-2	—	Set up the operation of the run-inhibition (POT, NOT) inputs. Normally it should be set to 1. 0: Deceleration stop on servo (MINAS-A6) side (sequence at time of run-inhibition input) POT -> positive direction drive inhibit, NOT -> negative direction drive inhibit. When POT is input during positive direction driving, stops the drive according to Pr5.05 Sequence at over-travel inhibit. The similar function NOT is applied in reverse direction. 1: CoE (CiA402) side deceleration stop *2) POT -> positive direction drive inhibit, NOT -> negative direction drive inhibit. When POT is input during positive direction driving or NOT is input during negative direction driving, EtherCAT profile slowdown defined in CoE(CiA402) works and stops it. The constants at the time of a slowdown differ for every control mode. For details, refer to 6-9-2 7) "Sequence at drive inhibition input (POT, NOT)" in Technical Reference EtherCAT Communication Specification (SX-DSV03242). 2: Deceleration stop on servo (MINAS-A6) side (Sequence at alarm) POT or NOT input activates Err 38.0 Run-inhibition input protection.
5	05 *2)	C	Sequence at over-travel inhibit	0-2	—	When Pr5.04 Over-travel inhibition = 0, specify the status during deceleration and stop after application of the over-travel inhibition (POT, NOT).
5	11	B	Torque setup for emergency stop	0-500	%	Set up the torque limit at emergency stop. When setup value is 0, the torque limit for normal operation is applied.

(To be continued)

Class	No.	Attribute *1)	Title	Range	Unit	Function
6	98	R	Function expansion setup4	-2147483648 - 2147483647	-	bit21 Extension of conditions for releasing over-travel inhibition 0 : Conventional specification 1 : Expansion specification
6	102	B	Setting of over-travel inhibition release level	0 - 2147483647	Command unit	Sets the absolute value of the position deviation amount by which the over-travel inhibition state is released when Pr5.04 "Over-travel inhibition input setting" = 1. When the absolute value of the position deviation amount is equal to or higher than the set value, the over-travel inhibition state will not be released. *3)

\*1) For parameter attribute, refer to Section 9-1.

\*2) With POT allocated to SI6 or NOT allocated to SI7, and Pr 5.04 "Over-travel inhibit input setup" is set to other than 1 (CoE side deceleration stop), Err38.2 "Over-travel inhibit input protection 3" occurs.

\*3) When Pr5.04 "Over-travel inhibition input setting"  $\neq$  1, and Pr6.102 "Setting of over-travel inhibition release level"  $>$  0, Err93.5 (Over-travel inhibition input protection 4) occurs.

## (2) Contents

- Detail of deceleration stop on servo (MINAS-A6) side (sequence at time of run-inhibition input) (Pr5.04 = 0)

Pr 5.04 *4)	Pr 5.05	During deceleration *5)		After stalling (Approx. 30 r/min or below)	
		Stopping method	Deviation	Operation after stopping	Deviation
0	Common	<ul style="list-style-type: none"> <li>• Forcibly controls the position. *1)</li> <li>• Forcibly stops position command generation. *1)</li> <li>• bit 11(Internal limit active) of 6041h (Statusword) is ON.</li> </ul>	—	<ul style="list-style-type: none"> <li>• Control mode depends on the command. *2)</li> <li>• bit 11(Internal limit active) of 6041h (Statusword) is ON.</li> </ul>	—
	0	• Dynamic brake (DB) *6)	Clear *3)	• Torque command=0 towards inhibited direction	Hold
	1	• Free run (DB OFF)	Clear *3)	• Torque command=0 towards inhibited direction	Hold
	2	<ul style="list-style-type: none"> <li>• Emergency stop *4) *7)</li> <li>• Torque limit=Pr 5.11</li> </ul>	Clear *3)	• Torque limit and torque command are as usual.	Hold

- \*1) During deceleration, the system is forced to perform position control, forcibly stopping the internal position command generating process.
- \*2) Stop a command in over-travel inhibit direction with the over-travel inhibit input set to ON.  
If a command is issued in over-travel inhibit direction, the command is neglected.
- \*3) During deviation clearing, the process that lets the internal command position to follow the feedback position is activated. At the instantaneous stopping and at the end of deceleration, position deviations/external scale deviations accumulated during deceleration are cleared.
- \*4) Emergency stop refers to a controlled immediate stop with servo-on.  
The torque command value is limited during this process by Pr 5.11 Emergency stop torque setup.  
In an emergency stop, normal operation is performed during the time between the input of the signal and the start of the emergency stop. If a command is stopped concurrently with the input of the signal, a torque disallowed by normal torque limitation may be output.  
To allow a stop with the torque specified in the Emergency stop torque setup, continue to send the normal command at least 4 ms after the input of the signal.
- \*5) Deceleration period is the time required for the running motor to speed down to 30 r/min. Once the motor speed drops below 30 r/min, it is treated as in stop state regardless of its speed.
- \*6) Stopping method is Free run (DB OFF) in dynamic brake non-compatible models.
- \*7) Pr6.14 "Emergency stop time at alarm" setting is invalid.

- Detail of CoE (CiA402) side deceleration stop (Pr5.04 = 1)

Pr5.04	control mode *3)	During deceleration *2)		After stalling (about 30 or less r/min)	
		Stopping method		Operation after a stopping	
1	Common	<ul style="list-style-type: none"> <li>• Hold a servo-on condition.</li> <li>• Bit 11(Internal limit active) of 6041h (Statusword) is ON.</li> </ul>		<ul style="list-style-type: none"> <li>• Hold a servo-on condition.</li> <li>• Bit 11(Internal limit active) of 6041h (Statusword) is ON.</li> </ul>	
	pp,pv,ip, csp, csv	Deceleration stop in 6085h (quick stop deceleration).		• No command acceptance towards inhibited direction *1)	
	tq, cst	Deceleration stop in 6087h(Torque slope).			

- \*1) When the drive inhibit input of the ON state can stop a command to towards inhibited direction.  
If you give a command in the towards inhibited direction, the command will be ignored.
- \*2) Deceleration period is the time required for the running motor to speed down to 30 r/min. Once the motor speed drops below 30 r/min, it is treated as in stop state regardless of its speed.

- In case of deceleration stop on servo (MINAS-A6) side (sequence at time of alarm) (Pr5.04 = 2)  
Err38.0 "Over-travel inhibit input protection" occurs when POT or NOT is turned ON.  
Therefore, the system operates according to Sequence at alarm, but not to this setting.

• Details on Pr6.102 "Setting of over-travel inhibition release level"

Sets the absolute value of the position deviation amount by which the over-travel inhibition state is released when Pr5.04 "Over-travel inhibition input setting" = 1. When the absolute value of the position deviation amount is equal to or higher than the set value, the over-travel inhibition state will not be released. When Pr5.04 "Over-travel inhibition input setting"  $\neq$  1, and Pr6.102 "Setting of over-travel inhibition release level"  $>$  0, Err93.5 (Over-travel inhibition input protection 4) occurs.

When Pr6.98-bit 21 "Extension of conditions for releasing over-travel inhibition" = 0  
(conventional specification)

POT/NOT input signal status	Pr6.102 *1)*2)	Position command direction *6)	Position deviation amount *3)	Operability *5)	
				Positive direction	Negative direction
Inputting POT	= 0	-	-	×	○
	> 0	-	$\geq$ Pr6.102	×	×
-		$<$ Pr6.102	×	○	
Releasing POT input *4)	= 0	-	-	○	○
	> 0	-	$\geq$ Pr6.102	×	×
-		$<$ Pr6.102	○	○	
Inputting NOT	= 0	-	-	○	×
	> 0	-	$\geq$ Pr6.102	×	×
-		$<$ Pr6.102	○	×	
Releasing NOT input *4)	= 0	-	-	○	○
	> 0	-	$\geq$ Pr6.102	×	×
-		$<$ Pr6.102	○	○	

In the case of Pr6.98-bit 21 "Extension of conditions for releasing over-travel inhibition" = 1  
(extended specification)

POT input signal status	Pr6.102 *1)*2)	Position command direction *6)	Position deviation amount *3)	Operability *5)	
				Positive direction	Negative direction
Inputting POT	= 0	-	-	×	○
	> 0	-	$\geq$ Pr6.102	×	×
-		$<$ Pr6.102	×	○	
Releasing POT input *4)	= 0	-	-	○	○
	> 0	-	$\geq$ Pr6.102	×	×
		Positive direction	$<$ Pr6.102	×	×
Stop or negative direction	$<$ Pr6.102	○	○		
Inputting NOT	= 0	-	-	○	×
	> 0	-	$\geq$ Pr6.102	×	×
-		$<$ Pr6.102	○	×	
Releasing NOT input *4)	= 0	-	-	○	○
	> 0	-	$\geq$ Pr6.102	×	×
		Negative direction	$<$ Pr6.102	×	×
Stop or positive direction	$<$ Pr6.102	○	○		

○: Operable, ×: Not operable, -: No dependency

\*1) Set Pr6.102 to 0 in the control modes except the csp control mode.

\*2) Set the value in consideration of the equipment environment.

Note that if the set value is small, the over-travel inhibition state may not be released.

\*3) Position deviation amount = | 607Ah(Target Position) + 60B0h(Position offset) - 6064h(Position actual value) |

\*4) It means the case where the POT/NOT input is released during over-travel inhibition by POT/NOT input.

\*5) Note that the motor operates when the conditions for over-travel inhibition release are satisfied.

\*6) It means the direction of command change of 607Ah (Target position).

### 6-3-2 Sequence at Servo-Off

Operation sequence of the servo-off state is set by 605Ah(Quick stop option code), 605Bh(Shutdown option code) and 605Ch (Disable operation option code).

Deceleration function on the servo (MINAS-A6) side is activated when these objects is zero.

Deceleration function on the CoE (CiA402) side is activated when these objects is non-zero.

This section explains deceleration function on the servo (MINAS-A6) side.

Please refer to section 6-9-2 "Option Code (deceleration stop sequence)" of Technical Document "EtherCAT Communication Specifications" (SX-DSV03242) for details of deceleration function on the CoE (CiA402) side.

#### (1) Relevant parameters

Class	No.	Attribute *1)	Title	Range	Unit	Function
5	06	B	Sequence at Servo-Off	0-9	—	Specify the status during deceleration and after stop, after servo-off.
5	11	B	Torque setup for emergency stop	0-500	%	Set up the torque limit at emergency stop. When setup value is 0, the torque limit for normal operation is applied.

1) For parameter attribute, refer to Section 9-1.

#### (2) Contents

##### • Details of Pr 5.06 (Sequence at Servo-Off)

Pr 5.06	During deceleration *4)		After stalling (Approx.30 r/min or below)	
	Stopping method	Deviation	Operation after stopping	Deviation
Common	<ul style="list-style-type: none"> <li>Forcibly controls the position. *1)</li> <li>Forcibly stops position command generation. *1)</li> </ul>	—	<ul style="list-style-type: none"> <li>Forcibly controls the position. *1)</li> <li>Forcibly stops position command generation. *1)</li> </ul>	—
0,4	• Dynamic brake (DB) *6)	Clear *2)	• Dynamic brake (DB) *6)	Clear *2)
1,5	• Free run (DB OFF)	Clear *2)	• Dynamic brake (DB) *6)	Clear *2)
2,6	• Dynamic brake (DB) *6)	Clear *2)	• Free run (DB OFF)	Clear *2)
3,7	• Free run (DB OFF)	Clear *2)	• Free run (DB OFF)	Clear *2)
8	<ul style="list-style-type: none"> <li>Emergency stop *3) *5) *7)</li> <li>Torque limit =Pr 5.11</li> </ul>	Clear *2)	• Dynamic brake (DB) *6)	Clear *2)
9	<ul style="list-style-type: none"> <li>Emergency stop *3) *5) *7)</li> <li>Torque limit =Pr 5.11</li> </ul>	Clear *2)	• Free run (DB OFF)	Clear *2)

\*1) During deceleration sequence or at the stop (servo OFF), the system has to control the position and to stop the generation of internal position command.

\*2) During deviation clearing process, the system causes the internal command position to follow up the feedback position. When executing the interpolation feed system command after servo ON, re-set the command coordinate of the host controller. The motor may operate sharply.

\*3) Emergency stop refers to a controlled immediate stop with servo-on. The torque command value is limited during this process by Pr 5.11 Emergency stop torque setup.

In an emergency stop, since normal operation is performed during the time between the servo OFF command and the start of the emergency stop, a torque disallowed by normal torque limitation may be output.

To allow a stop with the torque specified in the Emergency stop torque setup, continue to send the normal command at least 4 ms after the input of the servo OFF command.

\*4) Deceleration period is the time required for the running motor to speed down to 30 r/min. Once the motor speed drops below 30 r/min, it is treated as in stop state regardless of its speed.

\*5) After emergency stop start, please continue to send Servo off command (PDS command "Disable operation", "Shutdown", "Disable voltage", "Quick Stop") until the motor is stopped.

\*6) Stopping method is Free run (DB OFF) in dynamic brake non-compatible models.

\*7) Pr6.14 "Emergency stop time at alarm" setting is invalid.



## 6-3-3 Sequence at main power OFF

The operation sequence at the main power supply OFF is changed with combination, such as 6007h (Abort connection option code), Pr5.07 (main power off sequence), and Pr5.09 (main power off detection time).

Basically, the deceleration function defined in CoE (CiA402) is effective until the deceleration function on the servo (MINAS-A6) side is activated by detection of the insulation of the main power AC (between L1 and L3).

- When “No action” is set by 6007h = 0, the CoE (CiA402) deceleration function does not operate, and the deceleration function on the servo (MINAS-A6) side operates.
- When the voltage between P and N decreases, Err13.0 (Main power undervoltage protection (PN)) occurs with the highest priority, causing the operation in accordance with Pr5.10 (Sequence at alarm).

This section explains deceleration function on the servo (MINAS-A6) side.

Please refer to section 6-9-2 "1) Abort connection option code (6007h)" of Technical Document "EtherCAT Communication Specifications" (SX-DSV03242) for details of deceleration function on the CoE (CiA402) side.

## (1) Relevant parameters

Class	No.	Attribute *1)	Title	Range	Unit	Function
5	07	B	Sequence at main power OFF	0-9	—	Specify the status during deceleration after main power interrupt or after stoppage. *4)
5	08	B	L/V trip selection upon main power off	0-3	—	Select LV trip or servo OFF upon occurrence of main AC power alarm. *4) Setup the condition to detect main AC power OFF alarm when the main AC power is kept interrupted for a time longer than the time set by Pr7.14. bit 0 0: The servo off according to the setting of 6007h(Abort connection option code) or Pr5.07. 1: Trip with Err 13.1 Main power undervoltage protection. *2 ) bit 1 0: Detect main AC power OFF alarm only when servo is in ON state. 1: Always detect main AC power OFF alarm.
5	09	C	Detection time of main power off	20-2000 *3)	ms	Set up main AC power alarm detection time. *4) Main AC power OFF detection is disabled when the setting value is 2000.
5	11	B	Torque setup for emergency stop	0-500	%	Set up the torque limit at emergency stop. When setup value is 0, the torque limit for normal operation is applied
6	36	R	Dynamic brake operation input setup	0-1	—	Sets between enabling and disabling dynamic brake (DB) operation input by I/O. (Note) This function is available only when the main power is turned off. 0: Disabled 1: Enabled

\*1) For parameter attribute, refer to Section 9-1.

\*2) Err13.1 “Main power supply shortage voltage protection (AC off detection)” will not occur during execution of retreat operation using main power off as the trigger.

\*3) To use this setting with a smaller value than the shipment value, please check matching with your power supply environment.

\*4) Please do not change the shipment value setting with V frame.

## (2) Contents

- Details of Pr 5.07 (Sequence at main power OFF)

Pr 5.07	During deceleration *4)		After stalling (Approx.30 r/min or below)		
	Stopping method	Deviation	Operation after stopping		Deviation
			Pr6.36 = 0	Pr6.36 = 1	
Common	<ul style="list-style-type: none"> <li>• Forcibly controls the position. *1)</li> <li>• Forcibly stops position command generation. *1)</li> </ul>	—	<ul style="list-style-type: none"> <li>• Forcibly controls the position. *1)</li> <li>• Forcibly stops position command generation. *1)</li> </ul>		—
0,4	<ul style="list-style-type: none"> <li>• Dynamic brake (DB) *5)</li> </ul>	Clear *2)	<ul style="list-style-type: none"> <li>• Dynamic brake (DB) *5)</li> </ul>	Operation of dynamic brake is subjected to the state of dynamic brake switching input (DB-SEL). *6)	Clear *2)
1,5	<ul style="list-style-type: none"> <li>• Free run (DB OFF)</li> </ul>	Clear *2)	<ul style="list-style-type: none"> <li>• Dynamic brake (DB) *5)</li> </ul>		Clear *2)
2,6	<ul style="list-style-type: none"> <li>• Dynamic brake (DB) *5)</li> </ul>	Clear *2)	<ul style="list-style-type: none"> <li>• Free run (DB OFF)</li> </ul>		Clear *2)
3,7	<ul style="list-style-type: none"> <li>• Free run (DB OFF)</li> </ul>	Clear *2)	<ul style="list-style-type: none"> <li>• Free run (DB OFF)</li> </ul>		Clear *2)
8	<ul style="list-style-type: none"> <li>• Emergency stop *3) *7)</li> <li>• Torque limit =Pr 5.11</li> </ul>	Clear *2)	<ul style="list-style-type: none"> <li>• Dynamic brake (DB) *5)</li> </ul>		Clear *2)
9	<ul style="list-style-type: none"> <li>• Emergency stop *3) *7)</li> <li>• Torque limit =Pr 5.11</li> </ul>	Clear *2)	<ul style="list-style-type: none"> <li>• Free run (DB OFF)</li> </ul>		Clear *2)

- \*1) During deceleration sequence or at the stop (main power OFF), the system must control the position and stop the generation of internal position command.
- \*2) During deviation clearing process, the system causes the internal command position to follow up the feedback position. When executing the interpolation feed system command after servo ON, re-set the command coordinate of the host controller. The motor may operate sharply.
- \*3) Emergency stop refers to a controlled immediate stop with servo-on. The torque command value is limited during this process by Pr 5.11 Emergency stop torque setup.  
If a command is stopped concurrently with a power OFF detection, a torque disallowed by normal torque limitation may be output. To allow a stop with the torque specified in the Emergency stop torque setup, continue to send the normal command at least 4 ms after the power OFF detection.
- \*4) Deceleration period is the time required for the running motor to speed down to 30 r/min.  
Once the motor speed drops below 30r/min, it is treated as in stop state regardless of its speed.
- \*5) Stopping method is Free run (DB OFF) in dynamic brake non-compatible models.
- \*6) Dynamic brake operation input will be possible when Pr6.36 "Dynamic brake operation input setup" is effective and when main power supply is OFF. In the output signal assignment of Pr4.02 "SI3 input selection," when connected to COM- by a connection setting, dynamic brake installed inside the servo driver will be released, and when COM- is opened, the dynamic brake installed inside the servo driver will activate.  
This input will become invalid for Servo-ON, during trips, safety state or when the main power supply is switched ON and will follow the normal sequence setting.
- \*7) Pr6.14 "Emergency stop time at alarm" setting is invalid.

## 6-3-4 Sequence at alarm

Set the operation sequence at the alarm with the exception of the communication related alarm (Err80.\*, Err81.\*, Err85.\*, Err88.\*).

Communication related alarms (Err80.\*, Err81.\*, Err85.\*, Err88.\*) information, set by 605Eh (Fault reaction option code).

Please refer to section 6-9-2 "6) Fault reaction option code (605Eh)" of Technical Document "EtherCAT Communication Specifications" (SX-DSV03242) for details.

## (1) Relevant parameters

Class	No.	Attribute *1)	Title	Range	Unit	Function
5	10	B	Sequence at alarm	0-7	—	Specify the status during deceleration and after stop, after occurrence of alarm.

\*1) For parameter attribute, refer to Section 9-1.

## (2) Contents

- Details of Pr 5.10 (Sequence at alarm)

Pr 5.10	During deceleration *4)		After stalling (Approx.30 r/min or below)	
	Stopping method	Deviation	Operation after stopping	Deviation
Common	<ul style="list-style-type: none"> <li>• Forcibly controls the position. *1)</li> <li>• Forcibly stops position command generation. *1)</li> </ul>	—	<ul style="list-style-type: none"> <li>• Forcibly controls the position. *1)</li> <li>• Forcibly stops position command generation. *1)</li> </ul>	—
0	• Dynamic brake (DB) *6)	Clear *2)	• Dynamic brake (DB) *6)	Clear *2)
1	• Free run (DB OFF)	Clear *2)	• Dynamic brake (DB) *6)	Clear *2)
2	• Dynamic brake (DB) *6)	Clear *2)	• Free run (DB OFF)	Clear *2)
3	• Free run (DB OFF)	Clear *2)	• Free run (DB OFF)	Clear *2)
4	Action A *3) • Emergency stop *3) *5) • Torque limit =Pr 5.11	Clear *2)	• Dynamic brake (DB) *6)	Clear *2)
	Action B *3) • Dynamic brake (DB) *6)	Clear *2)		
5	Action A *3) • Emergency stop *3) *5) • Torque limit =Pr 5.11	Clear *2)	• Dynamic brake (DB) *6)	Clear *2)
	Action B *3) • Free run (DB OFF)	Clear *2)		
6	Action A *3) • Emergency stop *3) *5) • Torque limit =Pr 5.11	Clear *2)	• Free run (DB OFF)	Clear *2)
	Action B *3) • Dynamic brake (DB) *6)	Clear *2)		
7	Action A *3) • Emergency stop *3) *5) • Torque limit =Pr 5.11	Clear *2)	• Free run (DB OFF)	Clear *2)
	Action B *3) • Free run (DB OFF)	Clear *2)		

- \*1) During deceleration sequence or at the stop (during alarm or servo OFF), the system must control the position and stop the generation of internal position command.
- \*2) During deviation clearing process, the system causes the internal command position to follow up the feedback position. When executing the interpolation feed system command after servo ON, first re-set the command coordinate of the host controller. The motor may operate sharply.
- \*3) Action of A/B: When an alarm requiring emergency stop occurs, the action A is selected when the setup value in the table is set within the range 4 to 7, causing emergency stop of operation. When an alarm not requiring emergency stop occurs, it triggers dynamic braking (DB) specified by action B, or free-running. (Refer to Section 6-3-5.)  
Hold the main circuit power until deceleration stop is completed.  
For the alarm requiring emergency stop, refer to Section 7-1 Protective function list.
- \*4) Deceleration period is the time required for the running motor to speed down to 30 r/min. Once the motor speed drops below 30 r/min, and changes its status after stoppage, it is treated as in stop state regardless of its speed.
- \*5) Action B is performed when an alarm requiring emergency stop occurs while performing the dynamic braking (DB) operation with drive inhibition input sequence, sequence at the time of servo OFF or sequence at main power OFF or free-running.
- \*6) Stopping method is Free run (DB OFF) in dynamic brake non-compatible models.

6-3-5 Emergency stop upon occurrence of alarm

When an alarm requiring emergency stop occurs, the system controls and immediately stops the motor.

(1) Relevant parameters

Class	No.	At-tribute *1)	Title	Range	Unit	Function
5	10	B	Sequence at alarm	0-7	—	Specify the status during deceleration and after stop, after occurrence of alarm. Setting the parameter to one of 4 to 7, enables emergency stop.
5	11	B	Torque setup for emergency stop	0-500	%	Set up the torque limit at emergency stop. When setup value is 0, the torque limit for normal operation is applied
5	13	B	Over-speed level setup	0-20000	r/min	If the motor speed exceeds this setup value, Err26.0 Over-speed protection occurs. When setup value is 0, the over-speed level becomes internal value of the over-speed protection level speed. *2)
6	14	B	Emergency stop time at alarm	0-1000	ms	Set up the time allowed to complete emergency stop in an alarm condition. Exceeding this time puts the system in alarm state. When setup value is 0, emergency stop is disabled and the immediate alarm stop is enabled.
6	15	B	2nd over-speed level setup	0-20000	r/min	When the motor speed exceeds this setup time during emergency stop sequence in an alarm condition, Err 26.1 2nd over-speed protection will be activated. When setup value is 0, the over-speed level becomes internal value of the over-speed protection level speed. *2)

\*1) For parameter attribute, refer to Section 9-1.

\*2) Except some motors.

(2) Contents

- Emergency stop sequence upon occurrence of the alarm requiring emergency stop.

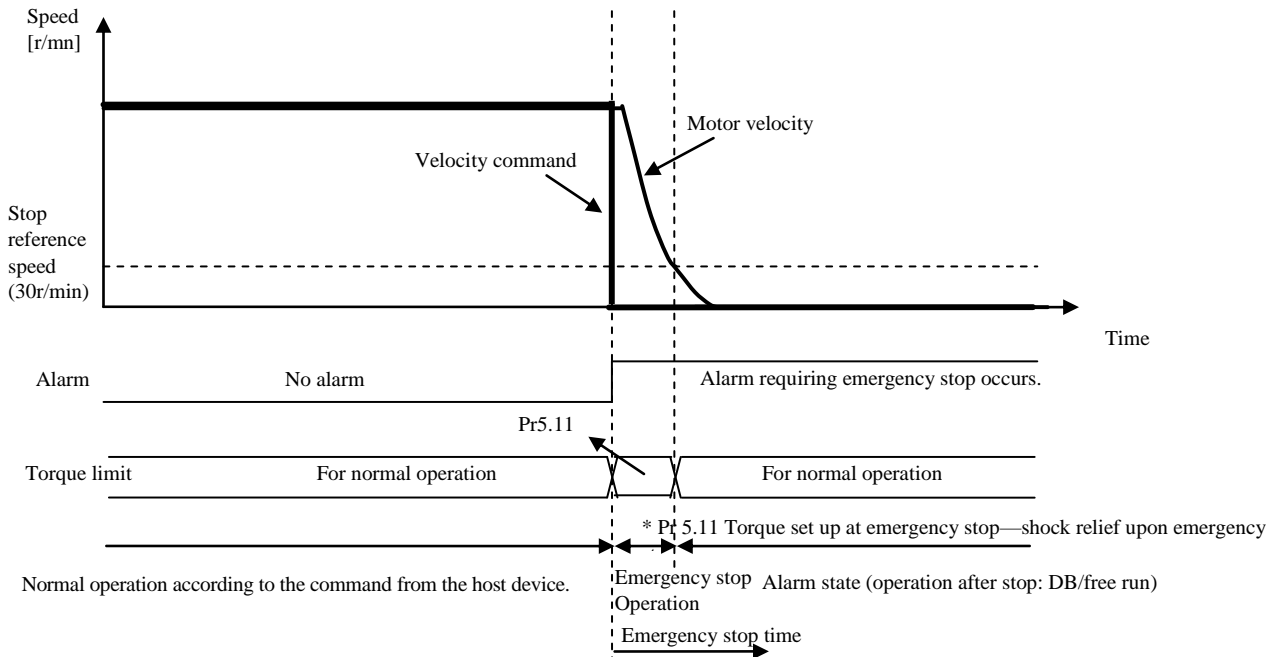

After occurrence of an alarm requiring emergency stop: when the speed has not dropped down to 30 r/min after the elapse of time set by Pr 6.14 Emergency stop time at alarm, the system generates the alarm. The system also enters the alarm state if an alarm that does not require emergency stop occurs in the driver during the sequence of the emergency stop.

- When an alarm requiring emergency stop occurs, normal operation (the normal torque limit is enabled) continues until an emergency stop is started. Therefore, if the command is interrupted during this period, the torque controlled with the normal torque limit may be output.

To stop operation with the emergency stop torque limit when an alarm requiring emergency stop occurs, continue to send the normal position command for at least 4 ms from the alarm notification.

<Bad example>

Turning on Forced alarm input (E-STOP) and stopping command at the same time

- Setting of Pr5.13 "Over-speed level setup" and Pr6.15 "2nd over-speed level"

The motor may not stop normally even if the emergency stop function is used.

For example, when the motor velocity exceeds Pr5.13 "Over-speed level setup" as shown in the figure below, the motor velocity may increase if normal control cannot be accomplished even after the start of emergency stop operation.

As a safety measure in case of this case, Err26.1 "2nd over-speed protection" is provided.

As Err26.1 is an alarm that does not require emergency stop, energization to the motor is shut off and the motor is stopped according to sequence at alarm, operation B. Set an allowable over-speed level for Pr6.15 "2nd over-speed level setup".

In addition, set Pr5.13 to a small value with a sufficient margin for Pr6.15. If the margin is insufficient or the set value is the same, both Err26.0 and Err26.1 may be detected. In this case, Err26.0 will be displayed. However, because Err26.1 is also activated internally, priority is given to the alarm that does not require emergency stop, and emergency stop is not executed.

Furthermore, if the Pr6.15 setting is smaller than the Pr5.13 setting, Err26.1 occurs prior to Err26.0.

Thus, emergency stop is not executed.

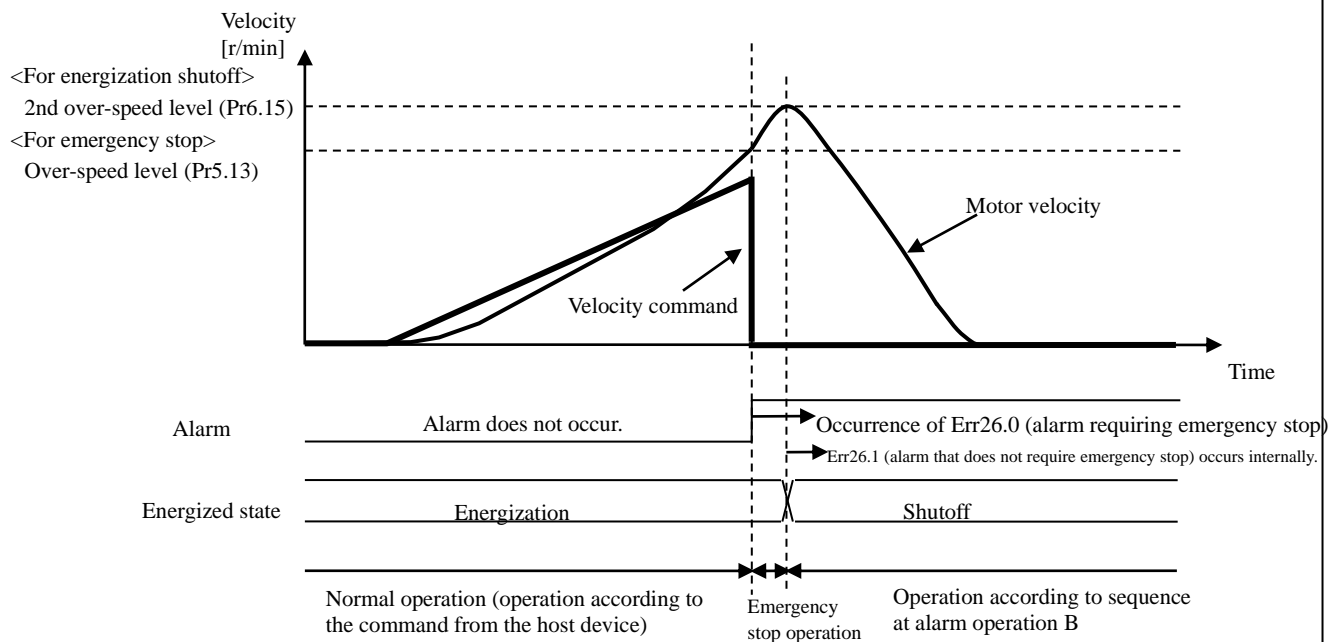

If the velocity has exceeded the value set in Pr6.15 "2nd over-speed level setup", energization is shut off and operation is performed according to sequence at alarm operation B.

6-3-6 Fall prevention function in the event of alarms/Servo-ON

6-3-6-1 Fall prevention function in the event of alarms

If the alarm requiring emergency stop has occurred, falling of the robot arm is prevented by maintaining the energization to the motor until the external brake is actually operated after the brake release output (BRK-OFF) is turned OFF.

This function can prevent a fall when alarm occurs by setting the sequence at alarm to emergency stop.

This function cannot be used for alarm that does not support emergency stop.

For details of Sequence at alarm, refer to Section 6-3-4 and 6-3-5.

For details of the alarm that supports emergency stop, refer to Section 7-1.

(1) Related parameters

Class	No.	Attribute *1)	Title	Range	Unit	Function
5	10	B	Sequence at alarm	0-7	—	Specify the status during deceleration and after stop, after occurrence of alarm. Setting the parameter to one of 4 to 7 enables emergency stop.
6	10	B	Function expansion setup	-32768-32767	-	Set the bit related to the fall prevention function. bit10 Fall prevention function in case of alarms 0: Invalid 1: Valid To enable the fall prevention function, normally set this parameter to 1. * The least significant bit is bit0.
6	51	B	Wait time for emergency stop	0-10000	ms	Set the time to maintain the motor energization after the brake release output (BRK-OFF) is turned OFF in the event of an alarm requiring emergency stop. When the set value is 0, the fall prevention function is disabled. * This parameter is enabled even when Pr6.10 "Function expansion setup" is not set to bit10=1. To enable the fall prevention function, however, be sure to set Pr6.10 "Function expansion setup" to bit10=1.

\*1) For the parameter attributes, refer to Section 9-1.

(2) Contents

- Operation of the fall prevention function in the event of the alarm requiring emergency stop

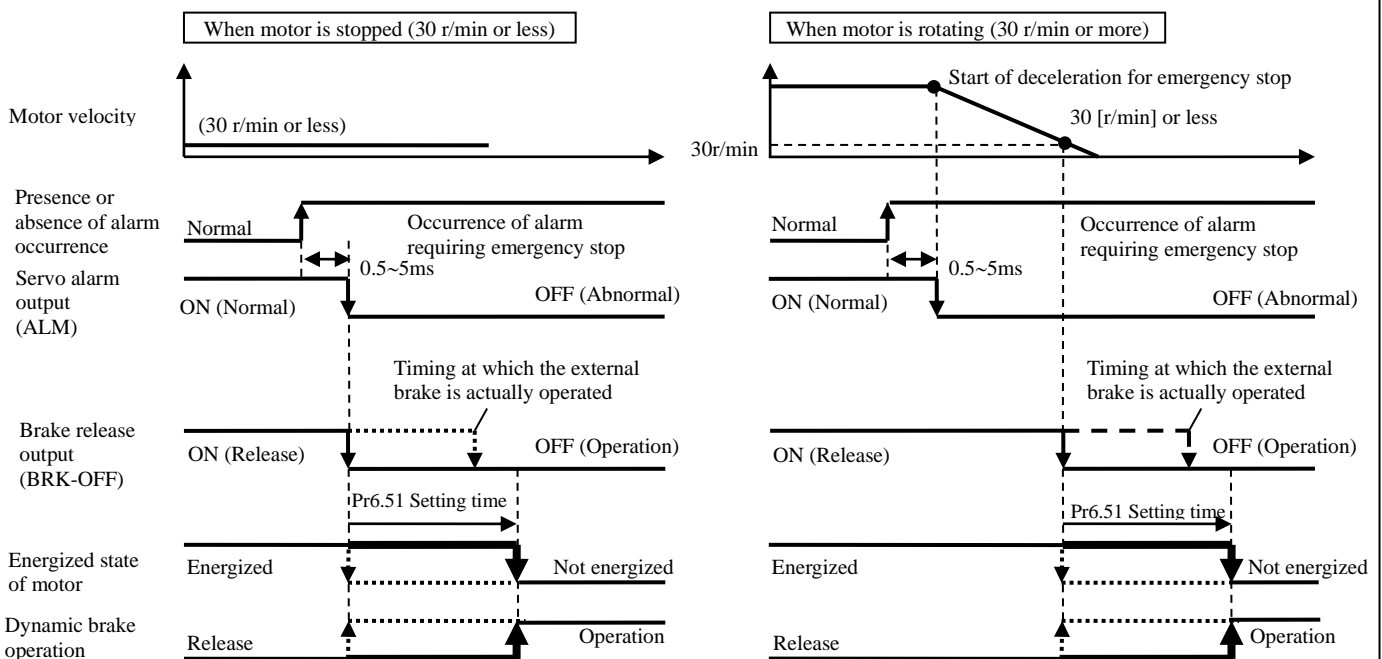

## 6-3-6-2 Fall prevention function in the event of Servo-ON

When the 60B2h(Torque offset) is used, enter the 60B2h(Torque offset) to torque filter at the time of servo-off, to eliminate the torque command the rise of the delay in the servo-on command input timing.  
And, it will prevent the fall of the device.

## (1) Related parameters

Class	No.	Attribute *1)	Title	Range	Unit	Function
7	24	C	Function expansion setup	-32768– 32767	–	bit7 : Internal value state selection of objects 60B2h (Torque offset) in servo-off(Fall prevention function in the event of Servo-ON) 0: Clear 1: Updated with the set value of 60B2h

\*1)For the parameter attributes, refer to Section 9-1.

## (2) Related object

Index	Sub-Index	Name / Description	Units	Range	Data Type	Access	PDO	Op-mode	EEPROM
37B3h	00h	Torque offset filter  • Set the time constant of primary delay filter for Torque offset filter (60B2h). (Note) It is not supported in versions corresponding to function extended edition 2 or earlier.	0.01ms	0 –6400	I16	rw	NO	ALL	YES
60B2h	00h	Torque offset  • Set the offset of the torque command (torque feedforward). • During slowdown in over-travel inhibition (in emergency stop), the torque feedforward level becomes 0.	0.1%	-32768 –32767	I16	rw	RxPDO	ALL	Yes



## 6-3-7 Slow stop function

allows the motor control to stop smoothly with the servo still remaining ON, when drive prohibited input, servo-OFF, main power OFF or emergency stop supporting alarm is detected under emergency stop setting.

## (1) Applicable Range

- This function cannot be applied unless the following conditions are satisfied.

Condition for activation of slow stop function	
Control mode	• Position control, Velocity control, Torque control *1) *2)
Others	• Servo-ON state • Elements other than control parameters, such as torque limit, etc. have been appropriately set, without any problems in normal operations.

\*1) During emergency stop, the control mode is forcibly set to position control.

\*2) Under full-closed control, the Slow Stop function is not supported.

Disable the Slow Stop function for full-closed control.

## (2) Related Parameters

Class	No.	Parameter name	Set range	Units	Functions
5	05	Sequence at over-travel inhibit	0 – 2	-	When Pr5.04 Over-travel inhibition = 0, specify the status during deceleration and stop after application of the over-travel inhibition (POT, NOT). * When the Slow Stop function is enabled, set up emergency stop
5	06	Sequence at Servo-Off	0 – 9	-	Specify the status during deceleration and after stop, after servo-off. * When the Slow Stop function is enabled, set up emergency stop
5	07	Sequence upon main power off	0 – 9	-	Specify the status during deceleration after main power interrupt or after stoppage. * When the Slow Stop function is enabled, set up emergency stop
5	10	Sequence at alarm	0 – 7	-	Specify the status during deceleration and after stop, after occurrence of alarm. * When the Slow Stop function is enabled, set up emergency stop
5	56	Slow stop deceleration time setting	0 – 10000	ms / (1000 r/min)	Sets the deceleration time under slow stop. This function will become effective when Pr6.10 “Function expansion setup” bit 15 is set to 1.
5	57	Slow stop S-shape acceleration and deceleration setting	0 – 1000	ms	Sets the S-shape time for deceleration under slow stop. This function will become effective when Pr6.10 “Function expansion setup” bit 15 is set to 1.
6	10	Function expansion setup	-32768 – 32767	-	bit 10: Fall prevention function in case of alarms 0: Invalid      1: Valid * To enable the slow stop function, set to 1. bit 15: Slow stop function 0 :Invalid      1: Valid * Set this to 0 for full-closed control.
6	14	Emergency stop time at alarm	0 – 1000	ms	Sets the allowable time for stopping when alarm is triggered for emergency stop. Exceeding this set value will trigger a forced alarm condition. In case the set value is 0 (zero), no emergency stop will be made, but an alarm condition will immediately occur. In case the slow stop function is to be used, set it to a length sufficiently longer than the maximum deceleration time, as the motor velocity will have a delay from the deceleration and stop command. This parameter is valid only for Sequence at alarm. This parameter is invalid for Sequence upon inputting of over-travel inhibition, Sequence at Servo-Off and Sequence at main power OFF. * Please refer to (3) of this section for maximum deceleration time.

## (3) Contents

## • Slow stop operation

The figure below indicates the case of slow stop operation under alarm.

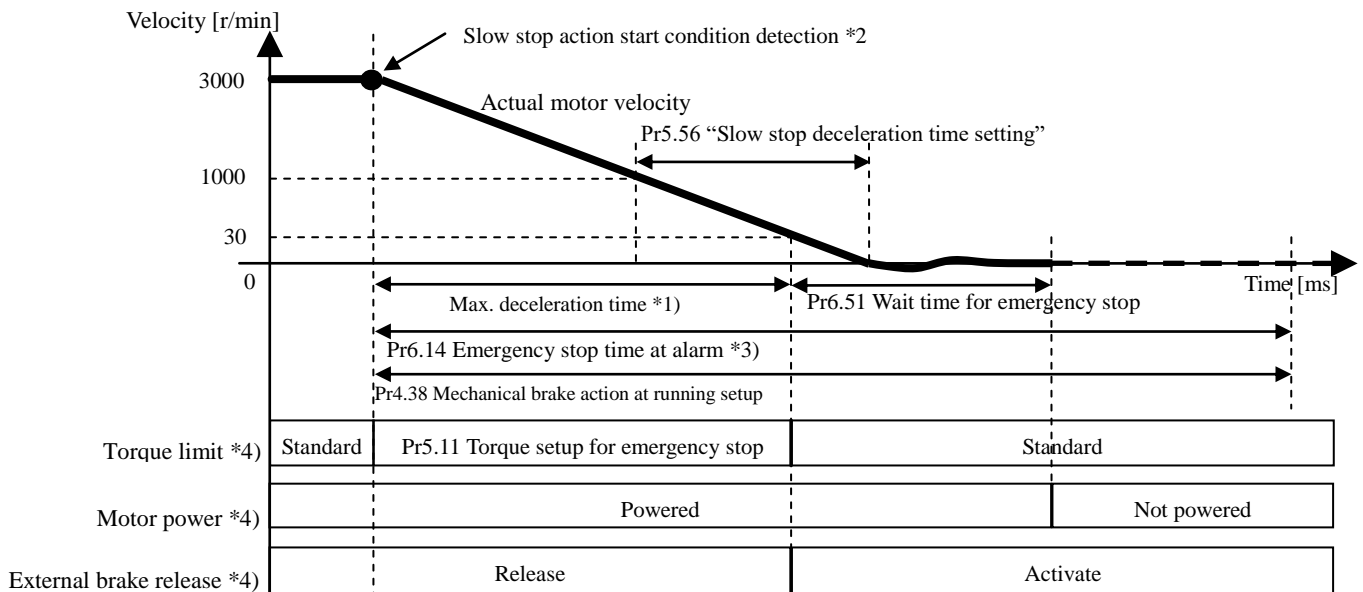

\*1) The maximum deceleration time is approximately the value obtained by the following formula:

Maximum deceleration time [ms]

$$= \frac{\text{Maximum velocity under normal operation pattern [r/min]} \times \text{Pr5.56 [ms/(1000 r/min)]}}{1000} + \text{Pr5.57 [ms]}$$

\*2) To be the detection of following conditions:

- Drive prohibited input with slow stop function valid setting.
- Servo-OFF with slow stop function valid setting.
- Main power OFF with slow stop function valid setting.
- Emergency stop response alarm triggered with slow stop function valid setting.

For the alarm supported emergency stop, refer to 7-1.

\*3) Please set Pr6.14 "Emergency stop time at alarm" to a value that is sufficiently long in length than the completion of slow stop operation. The stop judgment under slow stop operation is based on actual velocity. Therefore, the time required for the actual deceleration may take longer than the maximum deceleration time. In the emergency stop operation from emergency stop response alarm, in case the emergency stop continuation duration exceeds Pr6.14 "Emergency stop time at alarm", an alarm state will be triggered regardless of the actual motor velocity.

Furthermore, immediate alarm condition will be triggered in case emergency stop non-response alarm is generated inside the driver during emergency stop.

Also, Pr6.14 "Emergency stop time at alarm" is valid only for Sequence at alarm.

Pr6.14 "Emergency stop time at alarm" is invalid for Sequence upon inputting of over-travel inhibition, Sequence at Servo-Off and Sequence at main power OFF.

\*4) There will be a maximum variance of about 5 [ms] in the switching timing.

Note) Please maintain the main circuit power supply during the time of decelerated stop.

- S shape processing of slow stop operation

S shape process at the time of slow stop operation can be made by setting Pr5.57. Refer to the following figure to set Pr5.57.

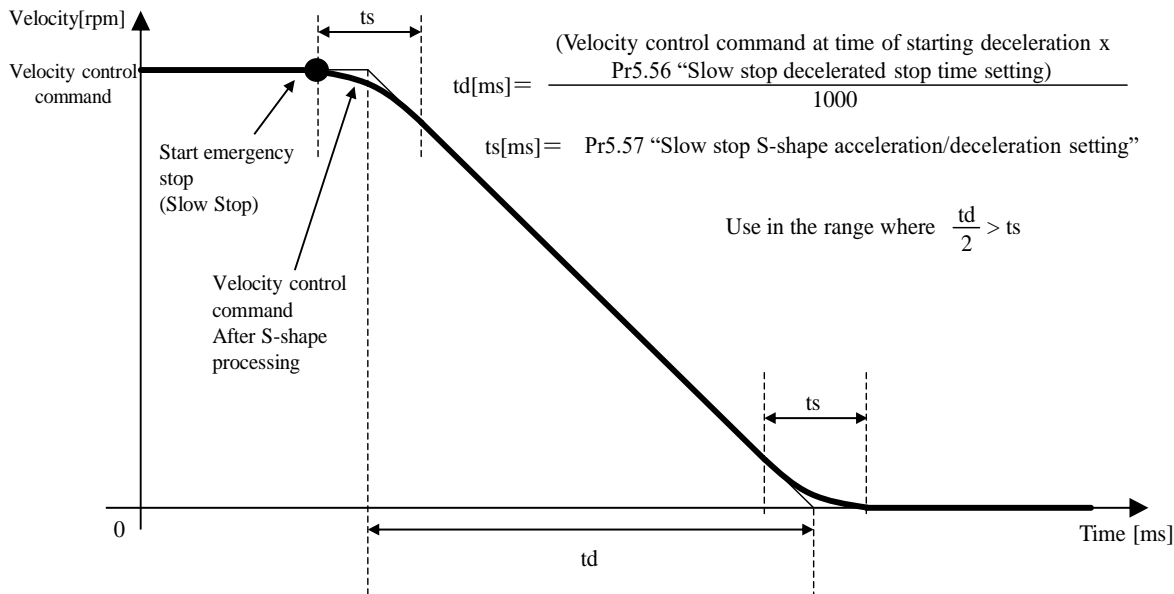

\*) Velocity control command at the time of starting slow stop operation shall be calculated from the actual velocity.

- Braking distance

When Pr 5.56 and Pr5.57 has been set, the braking distance under emergency stop will increase by approximately the following formula. Please confirm its influence on the actual machine operations, when using.

1) In case of linear deceleration (Pr5.57 =0)

Linear decelerating time [s]

$$= \frac{(\text{Velocity control command at time of starting deceleration [r/mom]} \times \text{Pr5.56 [ms/(1000)]r/min})}{1000 \times 1000}$$

Linear deceleration brake distance [revolution]

$$= \frac{(\text{Velocity control command at time of starting deceleration [r/min]} \times \text{Linear decelerating time [s]})}{60 \times 2}$$

$$= \frac{(\text{Velocity control command at time of starting deceleration [r/min]} )^2 \times \text{Pr5.56 [ms/(1000)]r/min}}{60 \times 2 \times 1000 \times 1000}$$

2) For S-shape deceleration (Pr5.57 ≠ 0)

S-shape deceleration braking distance [revolution]

$$= \text{Linear deceleration brake distance [revolution]} + \frac{(\text{Velocity control command at time of starting deceleration [r/min]} \times \text{Pr5.57 [ms]})}{60 \times 1000 \times 2}$$

Note) The above formulae are braking distances for the velocity control command only and the actual motor control delay has to be taken into account. Furthermore, in case the torque command under deceleration is restricted by emergency stop torque setting, the braking distance will not be as per the formulae indicated above.

## 6-4 Torque saturation protection function

If torque saturated has continued for a fixed period, an alarm can be activated.

■ Relevant parameters

Class	No.	Attribute *1)	Title	Range	Unit	Function
6	57	B	Torque saturation anomaly detection time	0-5000	ms	Set the torque saturation error protection detection time. If torque saturation erroneously occurs for a set time, Err16.1 "Torque saturation error protection" occurs. When 0 is set, the value set for Pr7.16 is enabled.
7	03	A	Output setting during torque limit	0-1	-	Sets the judgment condition for output during torque limit in the torque control mode. 0:ON in torque control mode 1:ON when torque is controlled in torque control mode
7	16	B	Frequency of torque saturation protection	0-30000	time	If torque saturated is continued during a preset frequency, Err 16.1 "Torque saturation protection" will be activated. The number of times is counted up every 0.25 ms. For example, when 30000 is set, Err16.1 occurs if the torque saturation condition continues for 7.5 seconds. The count is cleared when the torque saturation condition is removed. When the value set for Pr6.57 is other than 0, the value set for Pr6.57 is enabled.

\*1) For parameter attributes, refer to 9-1.

- Set both Pr6.57 and Pr7.16 to 0 to make this function disabled.
- When torque is controlled, this function is disabled and Err 16.1 will not be activated.
- If the emergency stop alarm is activated, this function is disabled and Err 16.1 will not be activated.
- During torque control, when Pr.7.03 is 0, the signal output during torque limit (TLC) is always ON.  
To check the torque limit during torque control, set Pr7.03 to 1.

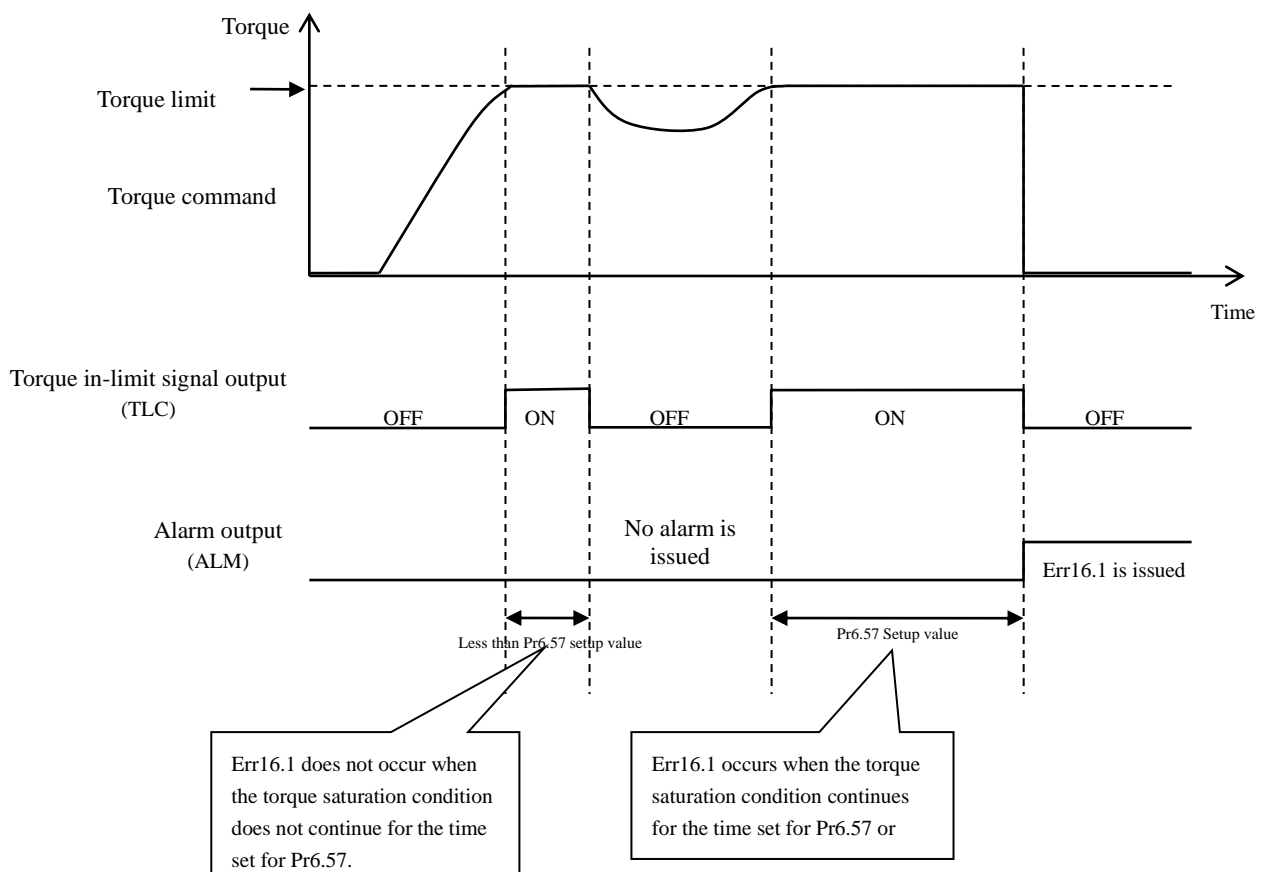

## 6-5 Position comparison output function

This function enables a general-purpose output or encoder output terminal to output a pulse signal when the actual position passes the position set for the parameter.

## (1) Specification

Trigger output	I/F	3-outputs : Photocoupler (Open collector) or 3-outputs : Line driver
	Logic	Parameter settings (The polarity can be set for each output)
	Pulse width	Parameter settings 0.1–3276.7ms (0.1ms unit)
	Delay compensation	Available
Compare source	Encoder (Communication)	Available
	External scale (Communication)	Available
	External scale (A,B-phase)	Available
Compare value	Setting points	8-points
	Setting range	Signed 32bit

## (2) Applicable Range

- This function cannot be applied unless the following conditions are satisfied.

Operating conditions for position comparison output function	
Control mode	• Available in all control modes
Other	• EtherCAT communication has been established. (ESM state is more than PreOP) • Home position return has been completed. • The elements other than control parameters are correctly set, assuring that the motor can run smoothly. • Other than Continuous rotating absolute mode (Pr0.15=4).

## (3) Caution

Position compare output accuracy may deteriorate under the following condition:

- In case the number of external scale pulses per one motor revolution is extremely lower than 23 bits, under full-closed control.

## (4) Related parameters

Class	No.	Attribute *1)	Title	Range	Unit	Function
4	44	R	Position comparison output pulse width setting	0-32767	0.1 ms	Set the pulse width of position comparison output. No pulse is output when 0 is set.
4	45	R	Position comparison output polarity selection	0-7	—	Set the polarity of position comparison output by bit setup for each output terminal. • Setup bits *2) *3) bit0: SO1 , OCMP1 bit1: SO2 , OCMP2 bit2: SO3 , OCMP3 • Setup values of Each setting bit 0: The output photocoupler is turned ON for SO1 to 3 and is set to L level for OCMP1 to 3, respectively, during pulse output. 1: The output photocoupler is turned OFF for SO1 to 3 and is set to H level for OCMP1 to 3, respectively, during pulse output. Basically, use this function as 0. ※Do not use SO3 with V frame.
4	47	R	Pulse output selection	0-1	—	Select the signal to be output from the encoder output terminal or position comparison output terminal. *3) 0: Encoder output signal(OA、OB) 1: Position comparison output signal(OCMP1~3)
4	48	A	Position comparison value 1	-2147483648-2147483647	Command unit	Set the comparison value for position comparison value 1.
4	49	A	Position comparison value 2	-2147483648-2147483647	Command unit	Set the comparison value for position comparison value 2.
4	50	A	Position comparison value 3	-2147483648-2147483647	Command unit	Set the comparison value for position comparison value 3.
4	51	A	Position comparison value 4	-2147483648-2147483647	Command unit	Set the comparison value for position comparison value 4.
4	52	A	Position comparison value 5	-2147483648-2147483647	Command unit	Set the comparison value for position comparison value 5.
4	53	A	Position comparison value 6	-2147483648-2147483647	Command unit	Set the comparison value for position comparison value 6.
4	54	A	Position comparison value 7	-2147483648-2147483647	Command unit	Set the comparison value for position comparison value 7.
4	55	A	Position comparison value 8	-2147483648-2147483647	Command unit	Set the comparison value for position comparison value 8.
4	56	R	Position comparison output delay compensation amount	-32768-32767	0.1 us	Compensate the delay in the position comparison output signaled by the circuit.
4	57	R	Position comparison output assignment setting	-2147483648-2147483647	—	Set the output terminals corresponding to position comparison values 1 to 8 by bit setup. Multiple position comparison values can be set up on one output terminal. • Setup bits bit0 to 3 : Position comparison value 1 bit4 to 7 : Position comparison value 2 bit8 to 11 : Position comparison value 3 bit12 to 15 : Position comparison value 4 bit16 to 19 : Position comparison value 5 bit20 to 23 : Position comparison value 6 bit24 to 27 : Position comparison value 7 bit28 to 31 : Position comparison value 8 • Setup values of Each setting bit *2) *3) 0000b : Output disabled 0001b : Allocated to SO1 , OCMP1 0010b : Allocated to SO2 , OCMP2 0011b : Allocated to SO3 , OCMP3 Other than above : For manufacturer's use (Do not set.) ※Do not use SO3 with V frame.

\*1) For parameter attributes, see Section 9-1.

\*2) When general-purpose outputs (SO1 to SO3) are used as position comparison outputs (CMP-OUT), allocate the position comparison output (CMP-OUT) to Pr4.10 to Pr4.12 for all control modes.

\* Position compare outputs cannot be monitored from PANATERM and EtherCAT communications.

\*3) When the encoder output signals (OA, OB) are used as position comparison outputs (CMP-OUT), set Pr4.47 to "1".

## (5) Operation

- When the actual position of the encoder passes a position comparison value (Pr4.48 to Pr4.55), a pulse with the time width set for the position comparison output pulse width setting (Pr4.44) is output (Figure 6-5-1).

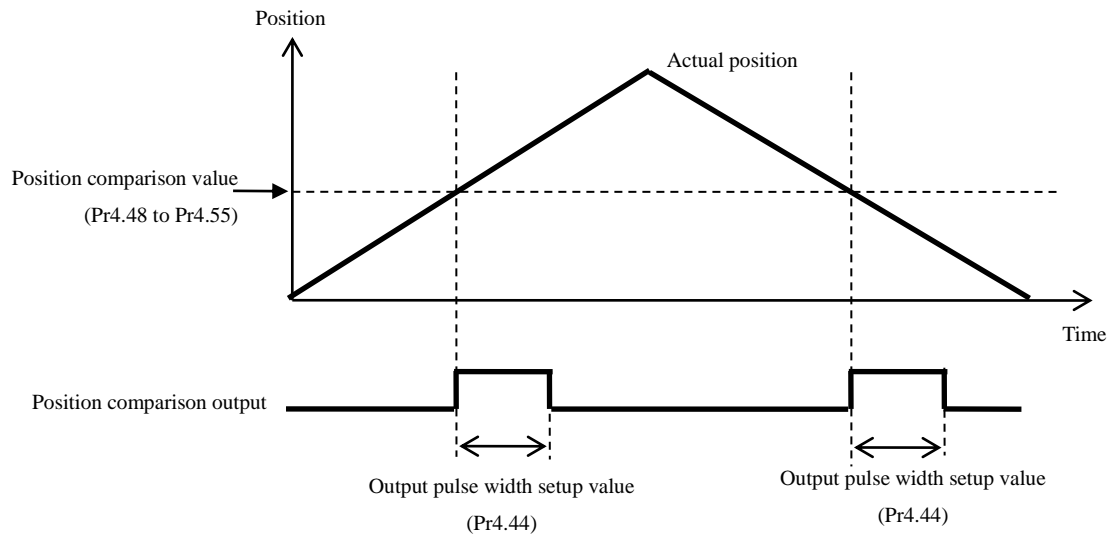

&lt;Figure 6-5-1&gt;

- A pulse is output when the position comparison value is passed and the relationship in size changes, irrespective of the passing direction of the encoder position.
- Multiple position comparison values can be set up on one position comparison output.
- If, during pulse output, the encoder position or external scale position passes the position comparison value in situations such as when the operation direction is reversed or multiple position comparison values are set, the ON status of pulse output continues throughout the period between the point of the last passage and the output pulse width setup value (Figure 6-5-2).

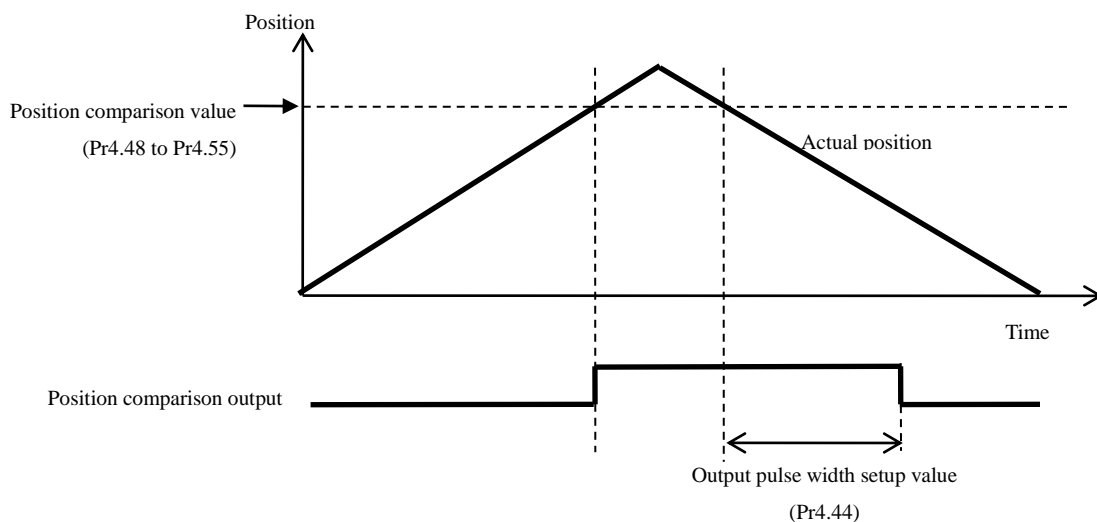

&lt;Figure 6-5-2&gt;

- Also when the position stops at the same position as the position comparison value, the pulse is output only once as with the case of passage.  
(Figure 6-5-3)

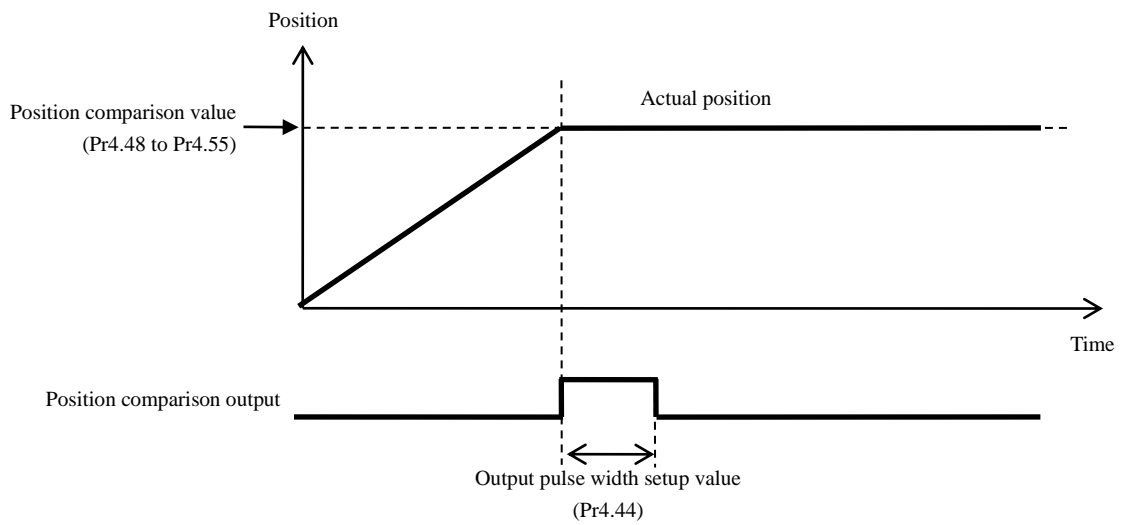

<Figure 6-5-3>

- The position comparison output function sends outputs while automatically compensating, based on the previous motor speed, the errors caused by the time of delay of encoder serial communication, etc. In addition, the amount of correction can also be adjusted with the setup of the amount of position comparison output delay correction (Pr4.56). For example, when using the position comparison output function as an operation trigger for the external device such as a camera, Pr4.56 can be set according to the delay time between the external device receiving the position comparison output signal and starting operation. (Figure. 6-5-4)

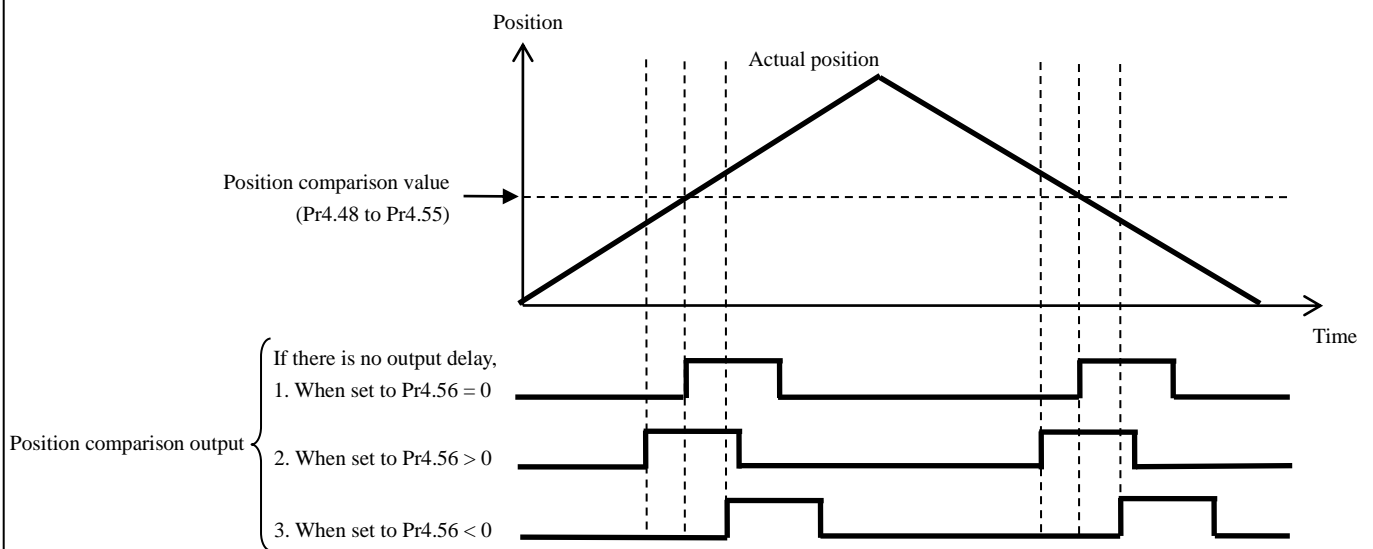

<Figure 6-5-4>



## 6-6 Single-turn absolute function

This function uses the absolute encoder as an absolute system only for single-turn absolute position data without connecting the battery power.

The movable range of the motor is limited by single-turn data of the absolute encoder.

## (1) Applicable Range

This function operates under the following conditions.

Operating conditions for the single-turn absolute function	
Control mode	Position control, Velocity control, Torque control
Others	The absolute encoder must be connected.

## (2) Caution

- This function is enabled by setting Pr0.15 "Absolute encoder setup" to 3.
- If the motor (encoder) position or command position exceeds the motor working range (single-turn data of the encoder), Err34.1 "Single-turn absolute working range error protection" occurs.
- When Err34.1 "Single-turn absolute working range error protection" has been activated, the motor is decelerated and stopped according to Pr5.10 "Sequence at alarm".
- When this function is enabled, multi-turn data for the absolute encoder is not used. Thus, alarms related to multi-turn data (Err40.0 "Absolute system down error protection", Err41.0 "Absolute counter over error protection", Err42.0 "Absolute over-speed error protection", and Err45.0 "Absolute multi-turn counter error protection") and battery alarms are not detected.
- Set 607Ch(Home offset) and electronic gear ratio while not allowing the actual position and command position to exceed  $2^{31}$ .

When  $(((((Pr6.88+1) \times \text{Encoder's resolution performance}) - 1) \times (\text{Electronic gear reverse conversion value})) + (607\text{Ch(Home offset)}))$  exceeds  $2^{31}$ , Err93.8 "Parameter setting fault protection 6" is generated.

## (3) Related parameters

Class	No.	Attribute *1)	Title	Range	Unit	Function
0	15	C	Absolute encoder setup	0-4	—	Select the use method of the absolute encoder. *2) 0: Use as an absolute mode. 1: Use as an incremental mode. *3) 2: Use as an absolute mode, but ignore the multi-turn counter over. 3: Use as an absolute mode, but not use multi-turn counter. (single-turn absolute mode) *3) 4: Use as an absolute mode, but any value can be set for the upper limit of the multi-turn counter, and ignore the multi-turn counter over.(Continuous rotating absolute mode)

\*1) For parameter attribute, refer to Section 9-1.

\*2) During full-closed controlling, treated as an incremental encoder (setting value = 1) for internal control.

\*3) Do not refer to the read value of multi-turn data in increment mode and single-turn absolute mode.

(4) Input range of the command position for EtherCAT communication

The following shows the input range of the command position when the single-turn absolute function is enabled. Note that the value below is the input range when the electronic gear ratio is 1/1 and the 607Ch (Home offset) is 0. For the input range when the electronic gear ratio and 607Ch (Home offset) are set, refer to the operation example in (5).

		Position command input range
Absolute encoder	23bit	0 ~ 2 <sup>23</sup> -1 (8388607)

(5) Operation example

The effective range of the single turn is as follows.

- i) CCW = Positive direction, electronic gear ratio = 1/1, 607Ch(Home offset) = 0

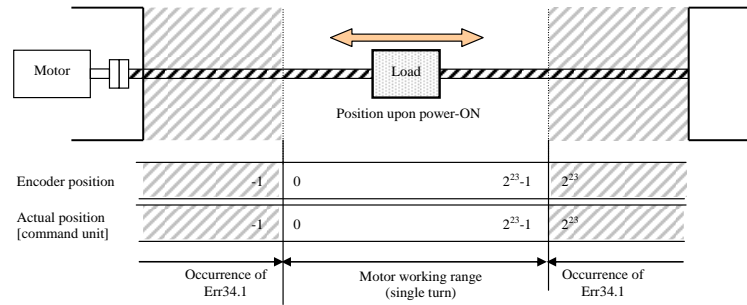

- ii) CCW = Positive direction, electronic gear ratio = 1/2, 607Ch(Home offset) = 0

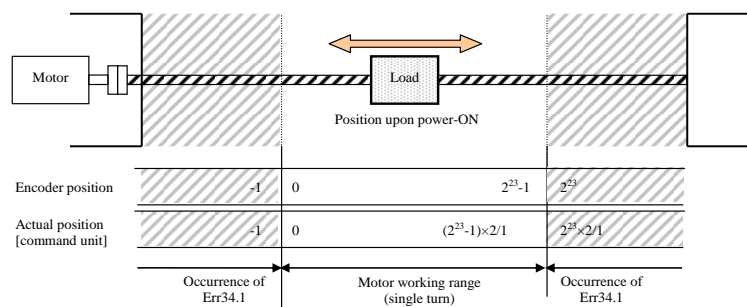

- iii) CCW = Positive direction, electronic gear ratio = 1/1, 607Ch(Home offset) = 10000

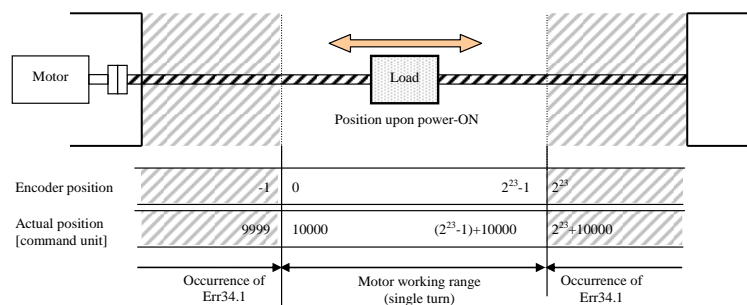

## (6) Cautions on the motor position upon power-ON

The motor working range is determined depending on the motor position upon power-ON.

(Operation example with a 23 bit absolute encoder)

- i) When the power-ON position is as shown in the figure below, the motor working range is the single-turn data range from the power-ON position.

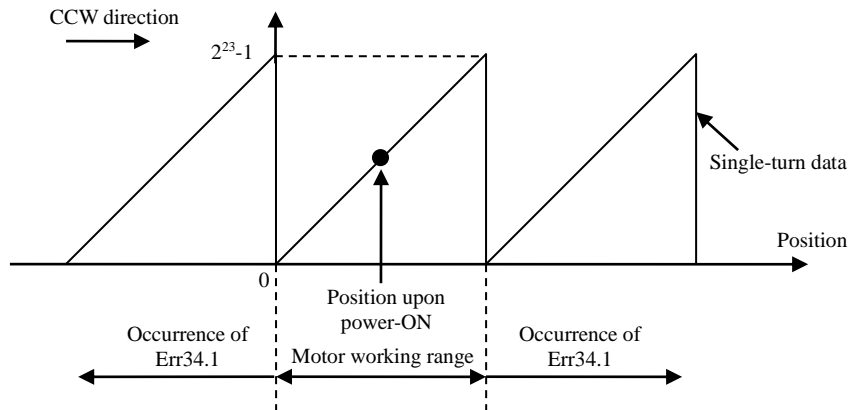

- ii) When the power is turned off at the position in Figure i) and then turned on again after the motor is moved to the position in the figure below, the motor working range will be changed.

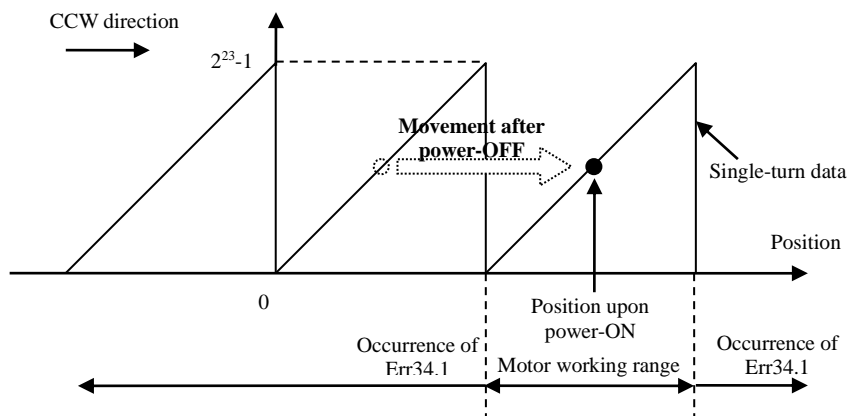

- iii) If the power is turned on when the power-ON position is near the limit of the motor working range, the motor working range is exceeded if the motor operates even if only slightly, causing Err34.1 "Single-turn absolute working range error protection".

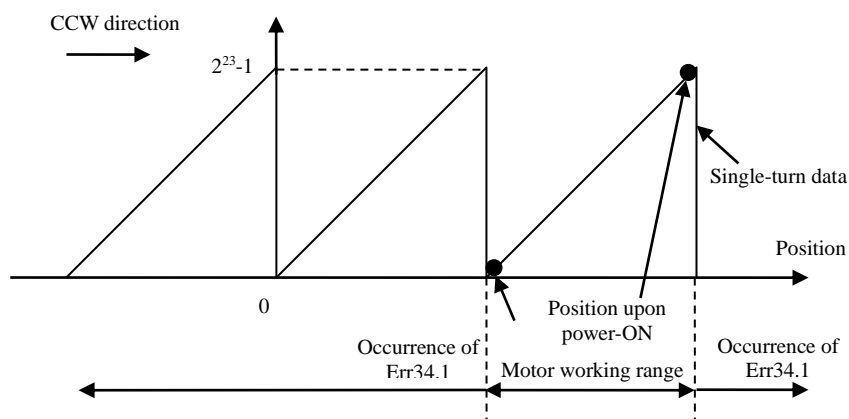

## 6-7 Continuous rotating absolute encoder function

This function allows you to set any upper limit value for absolute encoder multi-turn data.

With this function, it is possible to determine the turn angle (position) of a turntable and such other applications, even in the case of continuous turn in one direction.

In addition, because this is an absolute encoder, the home position return after the power is re-powered on is unnecessary.

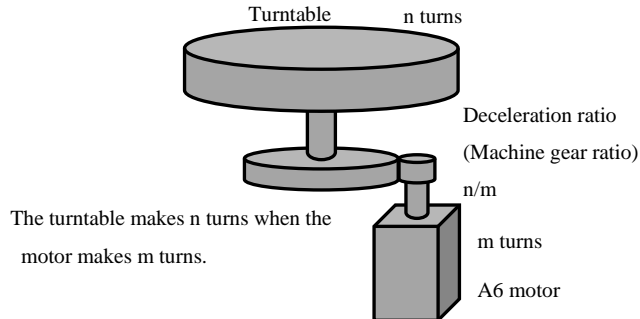

## (1) Applicable Range

- This function cannot be applied unless the following conditions are satisfied.

Operating conditions for continuous rotating absolute encoder function	
Control mode	• Position control, Velocity control, Torque control
Other	<ul style="list-style-type: none"> <li>• The encoder is a 23 bit resolution absolute encoder.</li> <li>• The following equation holds and the solution is an integer: Command position per turn of turntable = Encoder resolution (<math>2^{23}</math>) / electronic gear ratio / reduction ratio (<math>n / m</math>) is an integer less than or equal to (<math>2^{31}-1</math>).</li> <li>• The elements other than control parameters are correctly set, assuring that the motor can run smoothly.</li> </ul>

## (2) Related parameters

Class	No.	Attribute *1)	Title	Range	Unit	Function
0	15	C	Absolute encoder setup	0-4	-	Select the use method of the absolute encoder. *2) 0: Use as an absolute mode. 1: Use as an incremental mode. *3) 2: Use as an absolute mode, but ignore the multi-turn counter over. 3: Use as an absolute mode, but not use multi-turn counter. (single-turn absolute mode) *3) 4: Use as an absolute mode, but any value can be set for the upper limit of the multi-turn counter, and ignore the multi-turn counter over.(Continuous rotating absolute mode)
6	88	C	Absolute encoder multi-turn data upper-limit value	0-65534	-	Set the upper-limit value for absolute encoder multi-turn data when Pr0.15 is set to 4. When the multi-turn data is more than the value set for this parameter, the multi-turn data changes to 0. When the multi-turn data falls below 0, multi-turn data will change to the set value. When set to Pr0.15 = 0 or 2(absolute mode), the upper limit of the absolute rotation data becomes 65535, regardless of this setting. This setting will become invalid when Pr0.15 is set to 1 or 3. When Pr0.15 is set to 4, Pr6.88=0 makes a motion equivalent to that of Pr6.88=1.

\*1) For parameter attribute, refer to Section 9-1.

\*2) Handled as an incremental system (Set value =1) in internal control under full-closed control.

\*3) Do not refer to the read value of multi-turn data in increment mode and single-turn absolute mode.

## (3) Related object

Index	Sub-Index	Name / Description	Units	Range	Data Type	Access	PDO	Op-mode	EEPROM
607Ch	00h	Home offset	Command	-2147483648 - 2147483647	I32	rw	RxPDO	ALL	Yes

- After the homing position control mode (hm), position information is set so that the detected index pulse position becomes equal to the value of this object.  
Also, it is added to the position information at the following position information initialization(preset).
  - At the control power supply ON
  - When establishing communication (when changing ESM state from Init to PreOP)
  - When clearing absolute multi-turn
  - When PANATERM operation (test run function, frequency characteristic measurement, Z phase search, fit gain) is completed.
  - When executing pin assign by PANATERM.

## (4) Caution

- This function is available when Pr0.15 "Absolute encoder setup" is set to "4" with control power cycle is enabled.
- Set Pr6.88 "Absolute encoder multi-turn data upper-limit value" to "(m-1)".  
"m" corresponds to the denominator of the deceleration ratio.
- The actual position wraps around at the position at which multi-turn data wraps around.  
Give a position command so that the position will agree with this actual position.  
For the detail of the wraparound process, refer to Technical Reference, SX-DSV03242 "Section 6-9-4 5)", EtherCAT Communication Specification.
- When using absolute positioning for pp control or this function for csp control, set the movable position (not exceeding wraparound position, within Position range limit (607Bh)) to the target position.  
When set the position that can not be moved to the target position, Err91.1 (Command error protection) occurs. \*1)
- Set Pr6.88 "Absolute encoder multi-turn data upper-limit value" and electronic gear ratio while not allowing the actual position and command position to exceed  $2^{31}$ .  
When  $((Pr6.88+1) \times \text{encoder resolution}) - 1) \times (\text{Electronic gear reverse conversion value})$  exceeds  $2^{31}$ , Err93.8 "Parameter setting fault protection 6" is generated.
- The actual position is set based on 607Eh(Polarity) and 607Ch(Home offset) and so on.  
For details, refer to Technical Reference, SX-DSV03242 "Section 6-9-4 4)", EtherCAT Communication Specification.
- When this function is used for the first time, or Pr6.88 is changed to an arbitrary value and control power is re-input, Err92.3 "Inconsistency fault protection of multiple rotation data's upper limit values" is always generated. However, it is not a fault. Once the driver control power is re-powered on, the error will not occur from the next time.
- Refer to Section 4-6-1-1 for structure of absolute system.
- Set 607Ch(Home offset) between "0" to  $((Pr6.88 \text{ set value} + 1) \times \text{encoder resolution} - 1) \times (\text{Electronic gear reverse conversion value})$ .  
When wrong value is set, Err93.8 "Parameter setting error protection 6" occurs.

\*1) Err91.1 (command error protection) does not occur with the first edition of software version (V1.01).

## (5) Operation example

The operation is as follows in the case of the deceleration ratio ( $m = 50$ ,  $n = 4$ ) where the turntable makes 4 turns when the motor makes 50 turns.

- (1) Set Pr0.15=4 and Pr6.88=49, and write to EEPROM.
- (2) Re-power on the driver control power (or execute the attribute C enable command).
- (3) The upper-limit value of the multi-turn data on the encoder side is automatically updated when the driver is started up.
- (4) Err.92.3 "Multi-turn data upper-limit value disagreement error protection" occurs.
- (5) Re-power on the driver control power.
- (6) The multi-turn data upper-limit value is enabled and the actual position is generated as shown in the figure below.
- (7) The host device reads the actual position, and initializes the command position.
- (8) Because the actual position wraps around at  $2^{23} \times 50 - 1$ , allow for operation with the EtherCAT command position wrapped around in agreement with this.

\*Because the multi-turn data upper-limit value is retained with the battery power supply connected to the encoder, follow the steps from (6) above when you turn on the driver control power at the next and subsequent operations.

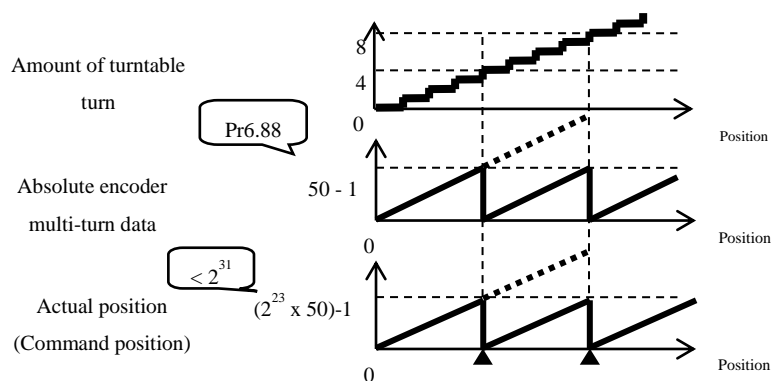

(6) Absolute home position offset

When continuous rotating absolute encoder function is used, the absolute home position offset is as shown below.

- i) CCW = Positive direction, electronic gear ratio = 1/1, Pr6.88 "Absolute encoder multi-turn data upper-limit value" = 2, 607Ch (Home offset) = 10000

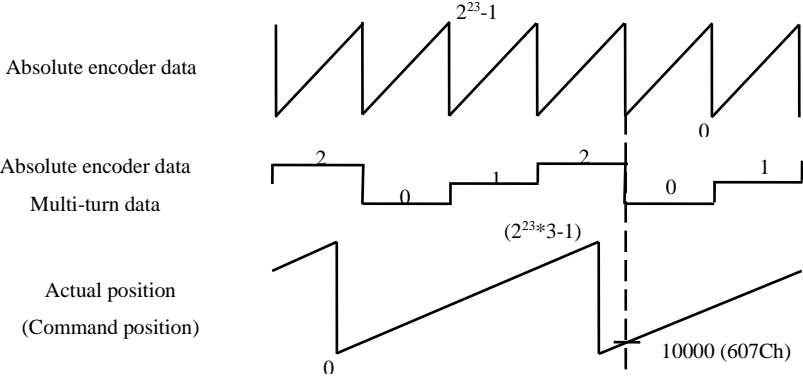

- ii) CW = Positive direction, electronic gear ratio = 1/1, Pr6.88 "Absolute encoder multi-turn data upper-limit value" = 2, 607Ch (Home offset) = 10000

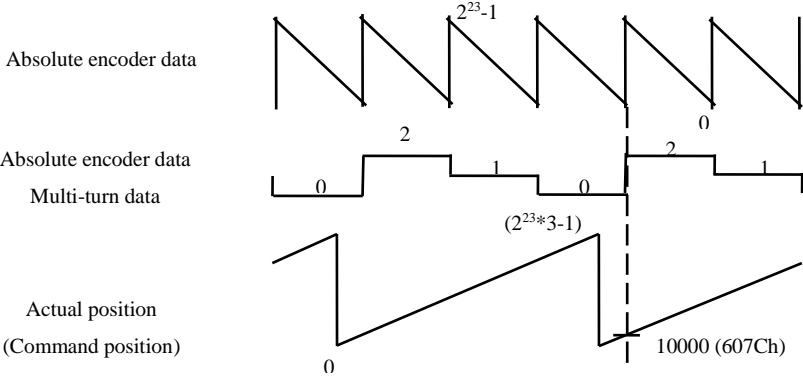

## 6-8 Deterioration diagnosis warning function

This is a function to check the changes in motor and connected equipment characteristics to output deterioration diagnosis warning.

## (1) Related parameters

Class	No.	Attribute * 1)	Parameter name	Set range	Units	Functions
5	66	A	Deterioration diagnosis convergence judgment time	0–10000	0.1s	Sets the time required to deem that real-time auto tuning load characteristics estimate has converged when deterioration diagnosis warning function is activated (Pr6.97 bit 1 = 1). When the set value is 0, it will be set automatically inside the driver in accordance with Pr6.31 (real-time auto tuning convergence velocity). * When Pr6.31 (real-time auto tuning convergence velocity) = 0, the deterioration diagnosis warning judgment for load characteristics estimate will be invalid.
5	67	A	Deterioration diagnosis inertia ratio upper limit value	0–10000	%	Sets the upper and lower limit values for inertia ratio estimate in deterioration diagnosis judgment when deterioration diagnosis warning is valid (Pr6.97 bit 1 = 1) and load characteristics estimate convergence has been completed. * The set resolution shall be in units of 0.2%.
5	68	A	Deterioration diagnosis inertia ratio lower limit value	0–10000	%	
5	69	A	Deterioration diagnosis unbalanced load upper limit value	-1000–1000	0.1%	Sets the upper and lower limit values for unbalanced load estimate in deterioration diagnosis judgment when deterioration diagnosis warning is valid (Pr6.97 bit 1 = 1) and load characteristics estimate convergence has been completed. * The set resolution shall be in units of 0.2%.
5	70	A	Deterioration diagnosis unbalanced load lower limit value	-1000–1000	0.1%	
5	71	A	Deterioration diagnosis dynamic friction upper limit value	-1000–1000	0.1%	Sets the upper and lower limit values for dynamic friction estimate in deterioration diagnosis judgment when deterioration diagnosis warning is valid (Pr6.97 bit 1 = 1) and load characteristics estimate convergence has been completed. * The set resolution shall be in units of 0.2%.
5	72	A	Deterioration diagnosis dynamic friction lower limit value	-1000–1000	0.1%	
5	73	A	Deterioration diagnosis viscous friction upper limit value	0–10000	0.1%/ (10000 r/min)	Sets the upper and lower limit values for viscous friction coefficient estimate in deterioration diagnosis judgment when deterioration diagnosis warning is valid (Pr6.97 bit 1 = 1) and load characteristics estimate convergence has been completed. * The set resolution shall be in units of 0.2%.
5	74	A	Deterioration diagnosis viscous friction lower limit value	0–10000	0.1%/ (10000 r/min)	
5	75	A	Deterioration diagnosis velocity setting	-20000 –20000	r/min	Outputs deterioration diagnosis velocity output (V-DIAG) when deterioration diagnosis warning is valid (Pr6.97 bit 1 = 1) and the motor velocity is within the range of Pr5.75 ± Pr4.35 (velocity coinciding width). * Deterioration diagnosis velocity output has a 10 [r/min] hysteresis.
5	76	A	Deterioration diagnosis torque average time	0–10000	ms	Sets time required to calculate the torque command average value when deterioration diagnosis warning is valid (Pr6.97 bit 1 = 1) and diagnosis velocity output (V-DIAG) is ON. * Time from diagnosis velocity output (V-DIAG) ON to the start judgment for upper and lower value of torque command average value is also a part of the set time for this parameter. *If the setting value is 0, the torque command average value is not calculated.
5	77	A	Deterioration diagnosis torque upper limit value	-1000–1000	0.1%	Sets the upper and lower limit values of torque command average value when deterioration diagnosis warning is valid (Pr6.97 bit 1 = 1) and deterioration diagnosis velocity output (V-DIAG) is ON.

(To be continued)



Class	No.	Attribute * (1)	Parameter name	Set range	Units	Functions
5	78	A	Deterioration diagnosis torque lower limit value	-1000–1000	0.1%	
6	97	B	Function expansion setup 3	-2147483648 – 2147483647	-	Bit 1 to set the deterioration diagnosis warning function to valid or invalid 0: invalid, 1: valid

\*1) For parameter attribute, refer to Section 9-1.

(2) Caution

- When the upper limit value is set to the maximum value, the upper limit judgment will become invalid.
- When the lower limit value is set to the minimum value, the lower limit judgment will become invalid.
- In case upper limit value  $\leq$  lower limit value, then both the upper limit and lower limit judgment will become invalid.
- Due to the USB communication delay, the average torque command value acquired via USB is compared with the actual value inside the servo driver  
It may be different. (0 may be displayed even when the actual value is not 0.)

(3) Contents

- Deterioration diagnosis warning functions for the following five types of data can be used by setting bit 1 of Pr6.97 “Function expansion setup 3” to 1.
  - Inertia ratio (3-1-1)
  - Unbalanced load (3-1-2)
  - Dynamic friction (3-1-3)
  - Viscous friction (3-1-4)
  - Torque command average value (3-2)

(3-1) Deterioration diagnosis warning for load characteristic estimates (Inertia ratio, Unbalanced load, Dynamic friction, Viscous friction)

- Deterioration diagnosis warning judgment for four load characteristics estimates (inertia ratio, unbalanced load, dynamic friction, and viscous friction coefficient) can be used in case real-time auto tuning load characteristics estimate is valid (refer to items 5-1-1, 5-1-3, 5-1-4).
- The abovementioned deterioration diagnosis warning judgment will become effective when the required operational conditions for load characteristics estimate has continued in total for Pr5.66 “deterioration diagnosis convergence judgment time” or more, and the load characteristics estimate has converged. Once it has become effective, it will remain in effect until Pr6.97 bit 1 is set to 0 (invalid) or the real-time auto tuning load characteristics estimate is invalidated.
- For each load characteristics estimate value, its upper and lower limit value can be set by the parameters as indicated in the following table. In case the load characteristic estimates has exceeded the upper or lower limit values for changes in load characteristics estimate, it generates deterioration diagnostic warning WngAC.

	(3-1-1)	(3-1-2)	(3-1-3)	(3-1-4)
	Inertia ratio	Unbalanced load	Dynamic friction	Viscous friction
Upper limit value	Pr5.67	Pr5.69	Pr5.71	Pr5.73
Lower limit value	Pr5.68	Pr5.70	Pr5.72	Pr5.74

\* Set resolution for the upper and lower limit of friction torque estimates (unbalanced load, dynamic friction, and viscous friction coefficient) shall be in units of 0.2%.

\* In case Pr6.31 “Real-time auto-tuning estimation speed” is set to 0 and is estimate stopped from the start or before the load characteristics estimate results has been confirmed, deterioration diagnosis warning judgment will become invalid even if real-time auto tuning load characteristics estimate is valid.

## (3-2) Deterioration diagnosis warning for constant velocity torque command average value

- Deterioration diagnosis velocity output (V-DIAG) is ON when the motor velocity is within the range of Pr4.35 “Speed coincidence range” of Pr5.75 “Deterioration diagnosis velocity setting”.
- When deterioration diagnosis velocity output (V-DIAG) is turned ON, torque command average calculation will start and after lapse of the set time of Pr5.76, deterioration diagnosis judgment by torque command average will become effective. This will continue while deterioration diagnosis velocity output (V-DIAG) remains output ON, however will return to invalid condition when the output is turned OFF.
- The upper limit and lower limit values for torque command average can be set by parameters Pr5.77 and 5.78 respectively. Deterioration diagnostic warning WngAC is generated in case these upper or lower limit values have been exceeded for changes in the load characteristic estimates.

## i) Example when deterioration diagnosis warning for torque command average value is not generated

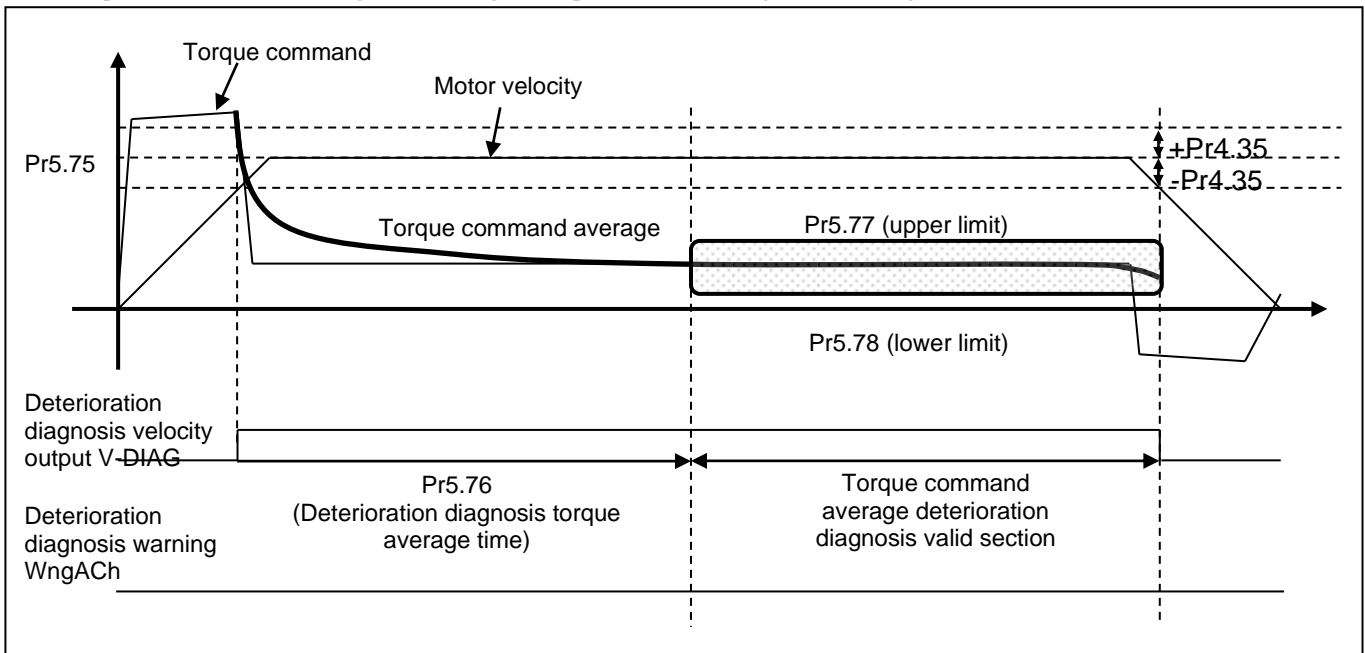

## ii) Example when deterioration diagnosis warning for torque command average value is generated

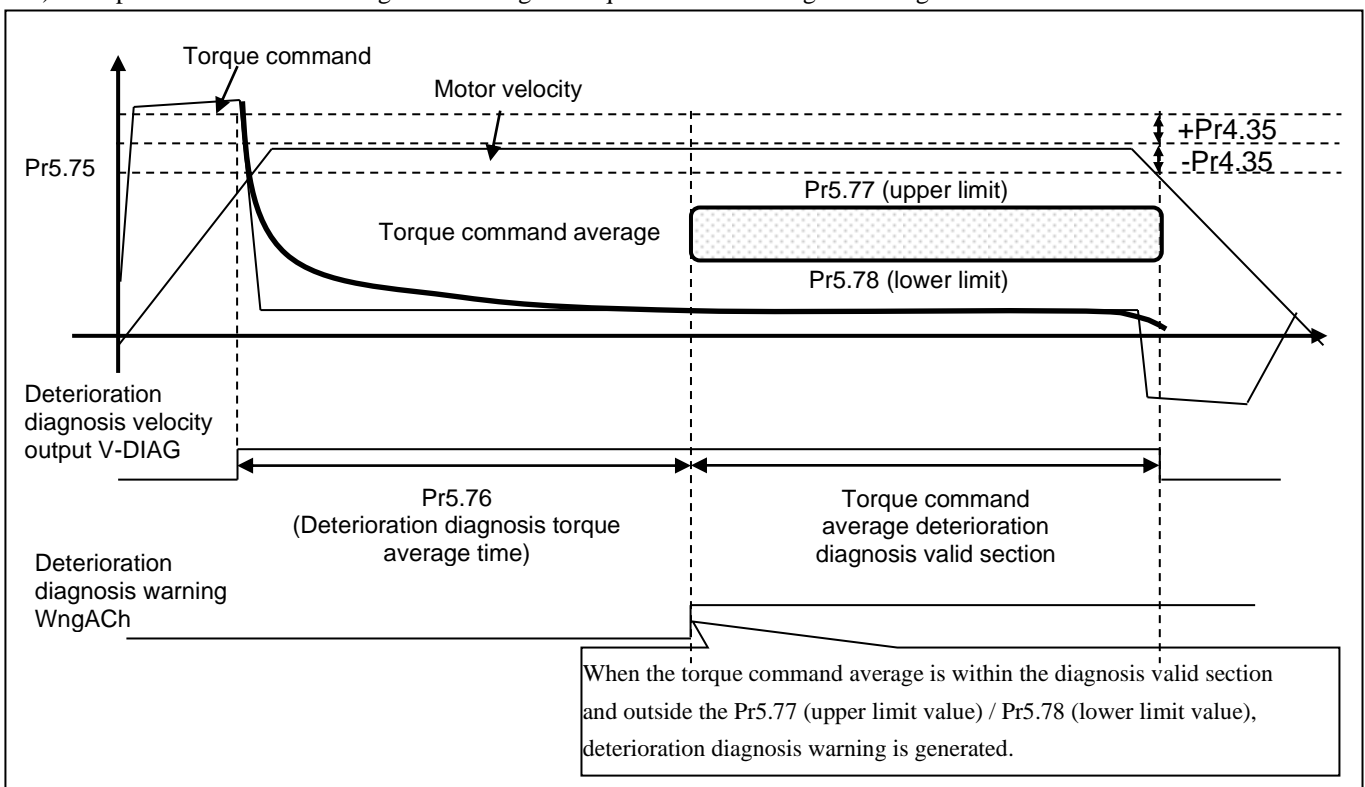

## 6-9 Retracting operation function

When one of the retracting operation activation conditions is established, a retracting operation is performed at the speed and movement amount set up by the relevant parameters.  
After the retracting operation is completed, an alarm is generated.

## (1) Applicable Range

This function operates under the following conditions.

Conditions under which the retracting operation function is activated	
Control mode	<ul style="list-style-type: none"> <li>• Can be used in all control modes</li> <li>Note) Do not switch the control mode during an retracting operation.</li> </ul>
Others	<ul style="list-style-type: none"> <li>• The software version shall be later than the function expanded version 1 and later (Ver1.02 and later)</li> <li>• The communication cycle is 0.25 ms or more.</li> <li>• Synchronization mode is DC or SM2.</li> <li>• An activation condition described in “(5) Retracting operation details” shall be established.</li> <li>• An activation cancellation condition described in “(5) Retracting operation details” shall not be established.</li> </ul>

## (2) Caution

- To confirm that retracting is in operation, check the 60FDh (Digital inputs) bit 25 “RET status [RET-STAT]”.
- If a retracting operation is activated during a return to origin operation, the operation is not guaranteed.
- If a return to origin operation is activated during a retracting operation, the operation is not guaranteed.
- Make sure that the origin position and the RET input position do not overlap.
- During a retracting operation, 6060h (Mode of operation) is ignored, and the control mode is forced to be pp mode (6061h (Mode of operation display) = 1 (pp)).  
Therefore, note that application of various filters and allocation of input and output signals during retracting operations conform to those for position control.  
In addition, on retracting operation completion, 6061h (Mode of operation display) is restored back to the value at the time of retracting operation start.  
When the control mode should be changed, wait until the retracting operation is completed and 6061h (Mode of operation display) is restored back to the value at the time of retracting operation start, and then change 6060h (Mode of operation).  
If the control mode is switched during a retracting operation, the operation is not guaranteed.
- In the Incremental mode, returning to origin is uncompleted (homing attained = 0) after Err87.1, Err87.2, or Err87.3 occurrence. After clearing the alarm, return to origin should be performed again.
- Note the direction of retracting operation, as Pr8.17 (Relative movement of retracting operation) is a signed data.  
To ensure safety, check the direction of retracting operation while setting Pr8.17 to a small value under the initial setting.
- PDS state will be Fault reaction active during retracting operation, and external commands will not be accepted.  
For details, refer to (5-7) “Retracting operation suspension conditions.”

## (3) Related parameters

Class	No.	Attribute *1)	Title	Range	Unit	Function																		
5	08	B	LV trip selection at main power supply OFF	0~3	—	Select whether LV trip or servo off is executed at main power supply alarm. It also sets up the conditions for main power supply off warning detection when the state in which the main power supply is cut off continues for the period set in Pr7.14 or longer. bit0 0 : Servo off is executed according to the setting in Pr5.07 or 6007h (Abort connection option code). 1 : Err13.1 “Main power undervoltage protection” detection *4) bit1 0 : Only servo on state is detected for main power supply off warning 1 : Main power supply off warning is constantly detected																		
5	09	C	Main power supply off detection time	20~2000 *3)	ms	Set the main power supply alarm detection period. Main power supply off detection is disabled when the setting value is 2000.																		
6	85	C	Retracting operation condition setting	-32768–32767	-	Select retracting operation activation and stop determination conditions. bit 3-0: Other than communication 0: Retracting operation by I/O disablement 1: RET input 2: RET/HOME input 3: Main power supply off detection *5) 4 to 15: Err87.3 occurs due to a setting error bit 7-4: Communication-related 0: Retracting operation disablement due to the establishment of one of the occurrence conditions of Err80.4 (PDO watchdog error protection), Err80.7 (Synchronization signal error protection), and Err85.2 (Lost link detection error protection) (If the condition is established, Err80.4, Err80.7, or Err85.2 occurs and the speed is reduced according to Fault reaction option code) 1: Establishment of one of the occurrence conditions of Err80.4, Err80.7, and Err85.2 2 to 15: Err87.3 occurs due to a setting error bit 9-8: Retracting operation stop determination condition <table border="1" data-bbox="869 1388 1460 1568"> <thead> <tr> <th>bit9</th> <th>bit8</th> <th>Position command transfer completion</th> <th>Positioning (target reached)*1)</th> </tr> </thead> <tbody> <tr> <td>0</td> <td>0</td> <td>Pre-filter determination</td> <td rowspan="2">Determination invalid</td> </tr> <tr> <td>0</td> <td>1</td> <td>Post-filter determination</td> </tr> <tr> <td>1</td> <td>0</td> <td>Pre-filter determination</td> <td rowspan="2">Determination valid</td> </tr> <tr> <td>1</td> <td>1</td> <td>Post-filter determination</td> </tr> </tbody> </table> *1)6041h (Statusword) bit 10 is used Example) In the case of bit 8=0 and bit 9=0, determination is made to stop retracting operation under the following conditions. - Determine completion of position command payment with value before filter - Positioning determination is invalid bit 15-10: Setting error if other than 0. Err87.3 occurs	bit9	bit8	Position command transfer completion	Positioning (target reached)*1)	0	0	Pre-filter determination	Determination invalid	0	1	Post-filter determination	1	0	Pre-filter determination	Determination valid	1	1	Post-filter determination
bit9	bit8	Position command transfer completion	Positioning (target reached)*1)																					
0	0	Pre-filter determination	Determination invalid																					
0	1	Post-filter determination																						
1	0	Pre-filter determination	Determination valid																					
1	1	Post-filter determination																						
6	86	C	Retracting operation alarm setting	0–7	-	Set retracting operation alarm clear attributes. bit 0: Err87.1 (Retracting operation completion (I/O)) 0: Not clearable, 1: Clearable bit 1: Err87.2 (Retracting operation completion (communication)) 0: Not clearable, 1: Clearable bit2: Err87.3 (Retracting operation error) 0: Not clearable, 1: Clearable																		

(To be continued)

Class	No.	Attribute *1)	Title	Range	Unit	Function
8	01	B	Profile linear acceleration constant	1-429496	10000 command unit/s <sup>2</sup>	Set the acceleration of retracting operations. Make sure that this is set before operation activation.
8	04	B	Profile linear deceleration constant	1-429496	10000 command unit/s <sup>2</sup>	Set the deceleration of retracting operations. Make sure that this is set before operation activation.
8	17	B	Relative movement of retracting operation *2)	-2147483647 - 2147483647	command unit	Set the amount of movement at the time of retracting operations based on the pre-filter command position. If the movement amount is 0 after the processing by the electronic gear, after emergency stop, no retracting operation is performed and Err87.1 or Err87.2 occurs. Make sure that this is set before operation activation. ※Please note the direction of retracting operation as this is a signed data.
8	18	B	Retracting operation speed	0- 2147483647	command unit/s	Set the speed of retracting operations. If 0 is set for this parameter, 1 is set internally. The maximum value is set internally to a smaller value between 6080h (Max motor speed) and the maximum motor speed. Make sure that this is set before operation activation.

\*1) For parameter attribute, refer to Section 9-1.

\*2) It is the relative amount of travel with the commanded position before the filter used as reference.

\*3) Please check the match in your power supply environment if you wish to use the system with the setting value changed from the shipment value.

\*4) Err13.1 “Main power undervoltage protection (AC off detection)” will not occur when retracting operation is executed using the main power supply off as the trigger.

\*5) To use main power supply off as the trigger, set Pr5.09 “Main power supply off detection time” to a value other than 2000. Detection of main power supply off itself will be disabled when Pr5.09 is 2000.

Please do not use this setting value with V frame.

## (4) Related alarms

Error No.		Alarm	Causes	Measures
Main	Sub			
80	4	PDO watchdog error protection	During PDO communication (SafeOP or OP state), bit10 of AL Event Request(0220h) did not turn on within the time is set ESC register addresses 0400h and 0420h.	<ul style="list-style-type: none"> <li>- Check whether the transmitting timing of PDO from host controller is constant (not stop).</li> <li>- Increase the timeout value of the PDO watchdog detection.</li> <li>- Check whether there is any problem in wiring of the EtherCAT telecommunication cable.</li> <li>- Check whether the excessive noise has started the EtherCAT communication cable.</li> </ul>
80	7	Synchronization signal error protection	More than the threshold value that the omission of the interruption processing by SYNC0 or IRQ set up by bit0-3 of Pr7.42 (Maximum continuation communication error) in after the completion of synchronous processing generated.	<p>&lt;In case of DC&gt;</p> <ul style="list-style-type: none"> <li>- Check setting of DC mode.</li> <li>- Check whether propagation delay compensation or drift compensation is correct.</li> </ul> <p>&lt;In case of SM2&gt;</p> <ul style="list-style-type: none"> <li>- Check whether the transmitting timing of PDO from host controller is constant.</li> <li>- Check whether there is any problem in wiring of the EtherCAT communication cable.</li> <li>- Check whether the excessive noise has started the EtherCAT communication cable.</li> <li>- The preset value of Pr7.42 (Maximum continuation communication error) bit0-3 is enlarged.</li> </ul> <p>- If the error cannot be resolved, shut off and reset the control power.</p>
85	2	Lost link error protection	The time set in Pr7.43 (Lost link detection time) elapsed when either Port 0 or Port 1 fell and remains in the lost link state after the ESM state transitioned from Init to PreOP (not including a port that had been in the lost link state at the time of transition from Init to PreOP).	<ul style="list-style-type: none"> <li>- Check whether there is any problem in wiring of EtherCAT communication cable.</li> <li>- Check whether there is any problem in the communication from higher rank equipment.</li> </ul>
87	1	Retracting operation completion (I/O)	This alarm occurs when a retracting operation by I/O is successfully completed. (Note) The first edition of the software version (Ver1.01) does not support this.	<ul style="list-style-type: none"> <li>- This is a security precaution, and there is no problem if it is an intended retracting operation.</li> <li>- It is an error that notifies the retracting operation execution.</li> </ul>
87	2	Retracting operation completion (communication)	This alarm occurs when a retracting operation by communication is successfully completed. (Note) The first edition of the software version (Ver1.01) does not support this.	<ul style="list-style-type: none"> <li>- Make sure that return to origin is performed after the alarm is cleared.</li> </ul>
87	3	Retracting operation error	<p>Retracting operation activation failed due to one of the following conditions. Otherwise, the retracting operation was suspended.</p> <ul style="list-style-type: none"> <li>- The setting for Pr6.85 "Retracting operation condition setting" is abnormal</li> <li>- Retracting operations are enabled and the communication cycle is less than 0.250 ms</li> <li>- Drive inhibit input (POT/NOT) is detected during a retracting operation</li> <li>- A Retracting operation execution condition is satisfied although drive inhibit input (POT/NOT) has been detected</li> <li>- A retracting operation execution condition is satisfied during an operation not according to the communication command from the host device (such as test run)</li> <li>- The retracting operation was suspended in response to alarm detection during a retracting operation</li> <li>- Retracting operation activation failed due to a servo-off state and such</li> </ul> <p>(Note)The first edition of the software version (Ver1.01) does not support this.</p>	<ul style="list-style-type: none"> <li>- Confirm that there are no errors in parameter settings.</li> <li>- Confirm that there is no problem in the operating environment.</li> <li>- Make sure that return to origin is performed after the alarm is cleared.</li> </ul>

## (5) Retracting operation details

## (5-1) Retracting operation activation conditions

A retracting operation is activated if either one of the conditions (1) and (2) is established.

## Condition (1)

Pr6.85 bit 3-0 = 1 and Retracting operation input (RET) switches from off to on

Pr6.85 bit 3-0 = 2 and either the following conditions a or b is established

a. Near home input (HOME) is on and Retracting operation input (RET) switches from off to on

b. After Retracting operation input (RET) switches from off to on and

before Err87.1/Err87.2/Err87.3 occurs and Retracting operation input (RET) is turned off,

Near home input (HOME) switches from off to on

When Pr6.85 bit3-0 = 3 and main power supply off is detected,

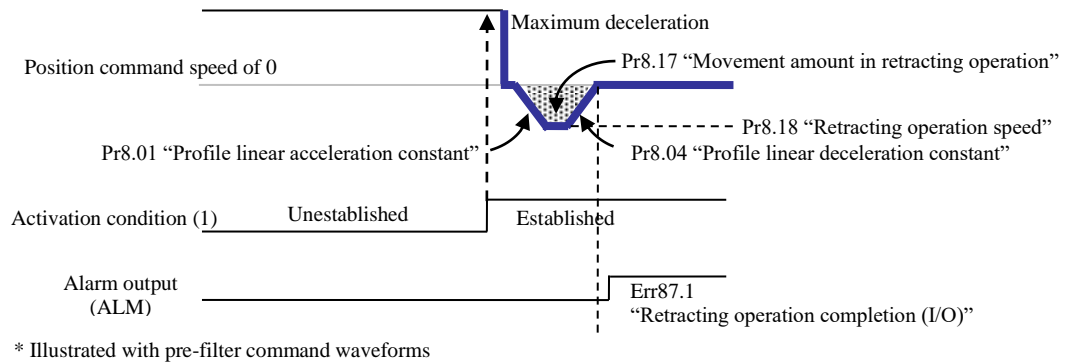

## Condition (2)

Pr6.85 bit 7-4 = 1 and a communication error (Err80.4/Err80.7/Err85.2) is detected

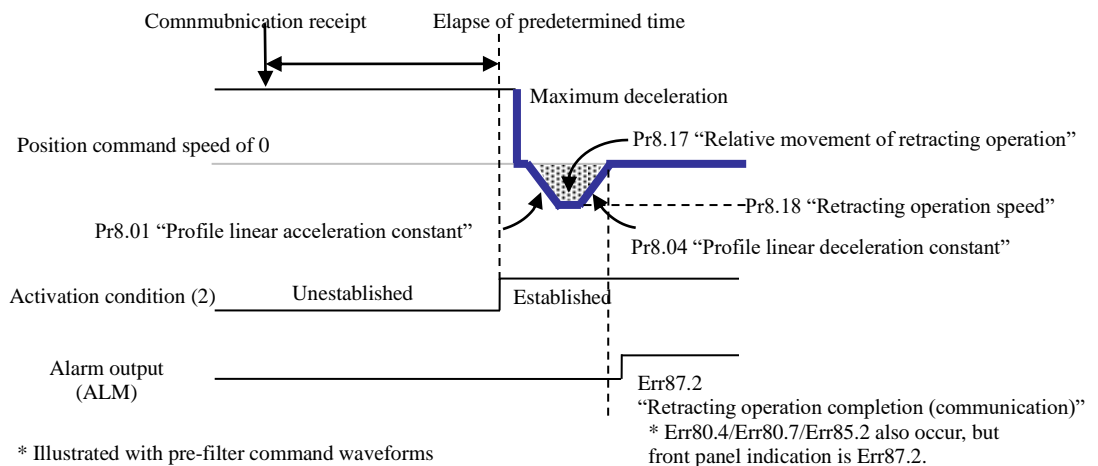

## (5-2) About external break control at the time of retracting operation completion

If Err87.1 or Err87.2 occurs on retracting operation completion, the falling of the robot arm and others can be prevented by maintaining the energization to the motor until the external brake is actually operated after the brake release output (BRK-OFF).

For details, refer to "6-3-6 Fall prevention function in the event of alarms/Servo-ON".

(5-3) Retracting operation activation during motor operations

If the retracting operation activation condition (1) or (2) is established during motor drive, the motor stops at the maximum deceleration speed and evacuates.

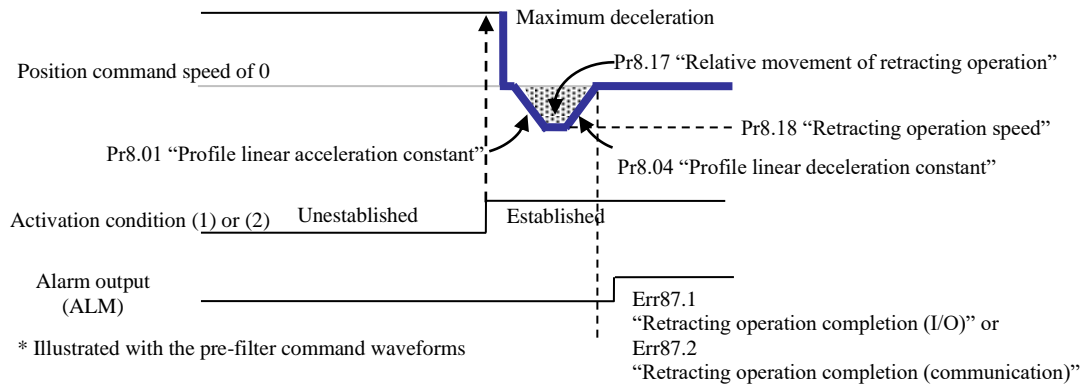

\* Illustrated with the pre-filter command waveforms

(5-4) Retracting operation activation during motor deceleration

If the retracting operation activation condition (1) or (2) is established under decelerated stop, the motor stops at the maximum deceleration speed and evacuates.

\* Under decelerated stop means the state of being decelerated to stop based on the position command.

Under decelerated stop due to servo-off, main power off, or alarm generation, or under decelerated stop due to drive inhibit input, even if the retracting operation activation condition (1) or (2) is established, the motor does not evacuate, the position command stops, deceleration starts according to the deceleration sequence at the time of the alarm, and Err87.3 occurs.

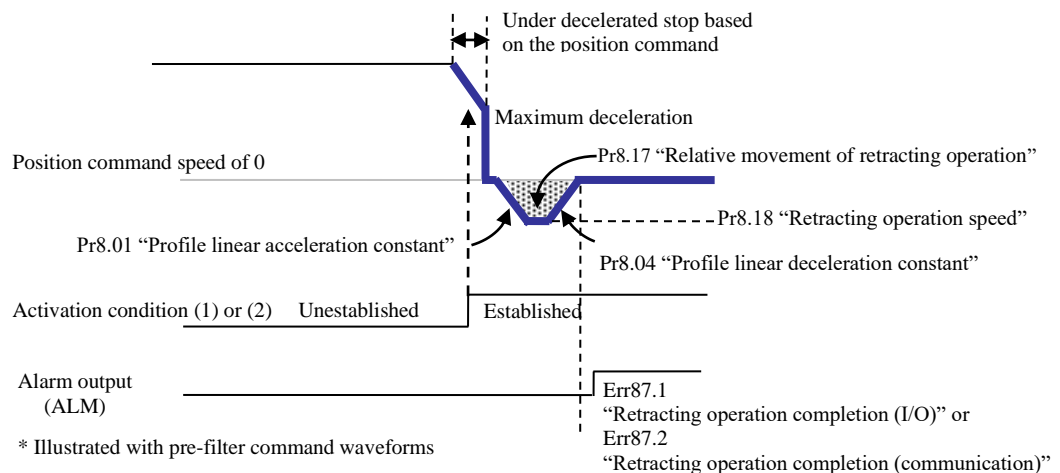

\* Illustrated with pre-filter command waveforms

(5-5) Retracting operation in motor stop state

If the retracting activation condition (1) or (2) is established in stop state, the motor evacuates.

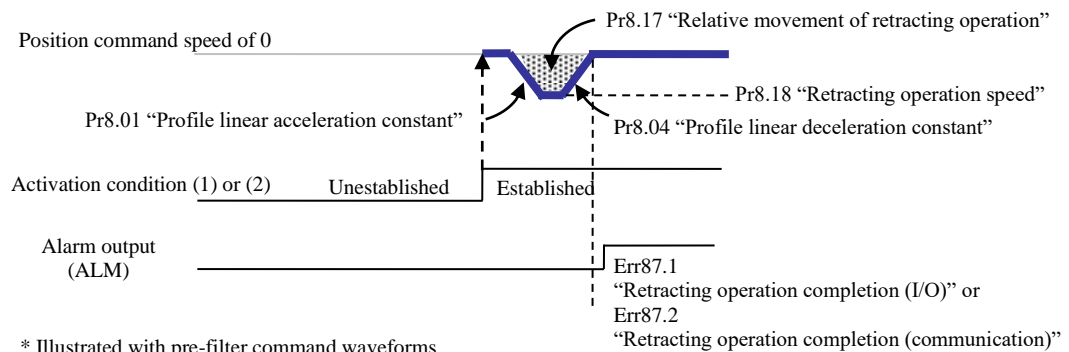

\* Illustrated with pre-filter command waveforms



## (5-6) Retracting operation activation cancellation conditions during motor drive

If one of the following activation cancellation conditions is established, regardless of the establishment of the retracting operation activation condition (1) or (2), the motor does not evacuate, the position command stops, deceleration starts according to the deceleration sequence at the time of the alarm, and Err87.3 occurs.

[Activation cancellation conditions]

- Drive inhibit input (POT, NOT) is ON
  - In operation independent of communication (such as test run)
  - Servo-Off
  - Under deceleration taking priority over retracting operations
- \* For the priority order, refer to section 6-9-2 in the Technical Document, EtherCAT Communication Specifications (SX-DSV03242).

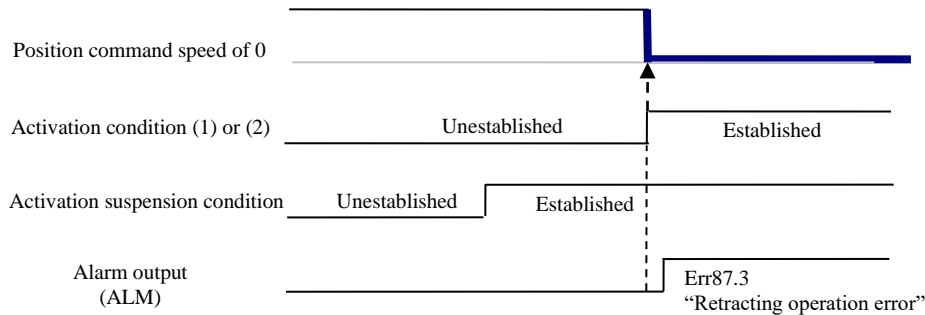

\* Illustrated with pre-filter command waveforms

## (5-7) Retracting operation suspension conditions

If one of the following execution suspension conditions is established during a retracting operation, the retracting operation is suspended, the position command stops, deceleration starts according to each deceleration sequence depending on the execution suspension condition, and Err87.3 occurs.

\* If the retracting operation activation condition is unestablished during an activation operation, the current operation continues.

[Execution suspension conditions]

- Drive inhibit input (POT, NOT) is ON
- Alarm generation
- Main power off (when Pr6.85 bit3-0 is not 3)
- STO input

\* Because the PDS is in a state of Fault reaction active during a retracting operation, servo-off by PDS state transition is unavailable. When using the retracting operation function, make sure that Force alarm input (E-STOP) is connected to have Err87.0 (Forced alarm input protection) generated by forced alarm input in an emergency and stop caused.

\* To prevent retracting operation suspension by main power off, it is recommended to set Pr5.09 (Main power off detection time) to 2000 (invalid). However, if voltage between P and N of the convertor portion of the main power supply falls below the specified value, Err13.0 (Main power undervoltage protection (PN)) occurs and the retracting operation suspends.

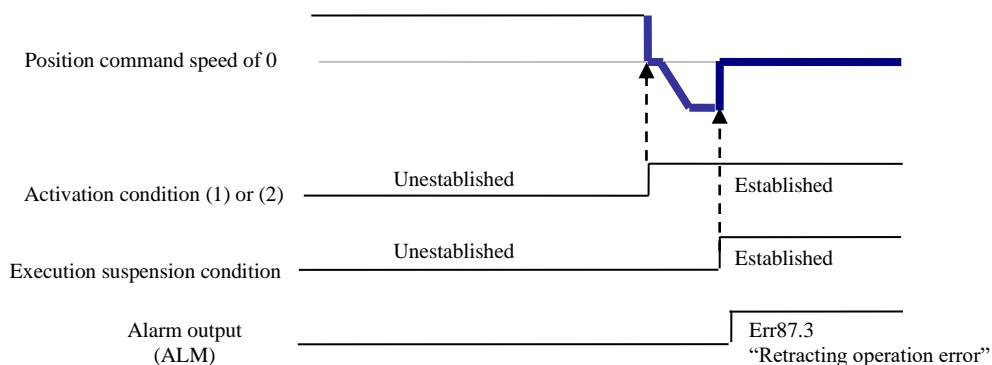

\* Illustrated with pre-filter command

## 6-10 Backlash compensation function

It is possible to correct the backlash (mechanical gap in drive system) during position control (including full-closed control).

(Example) Backlash compensation at the time of correction in the positive direction when operating in the positive direction

Conditions) Pr7.04 "Backlash compensation selection" = 1  
 • bit1-0=01b (Corrected when operated in the positive direction)  
 Pr7.05 "Backlash compensation amount" = 100 pulses  
 Pr7.06 "Backlash compensation time constant" = Arbitrary  
 Electronic gear ratio 1:1

[Operation in positive direction  
 => Operating in negative direction]

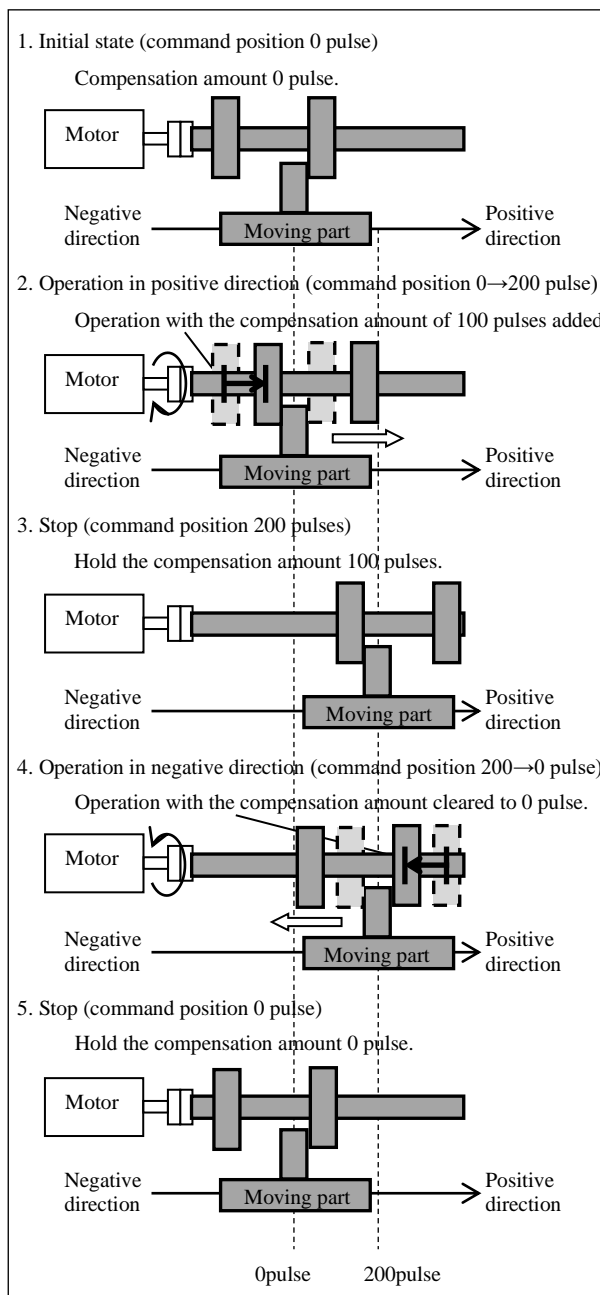

[Operation in negative direction  
 => operating in positive direction]

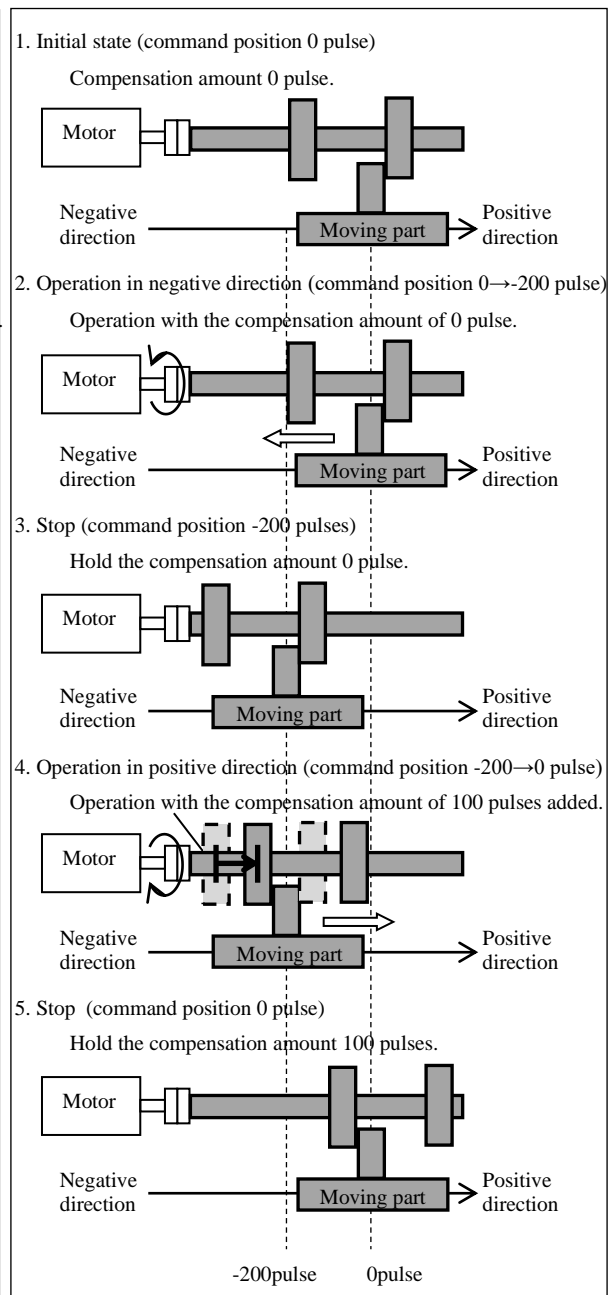

(Note) When the backlash compensation state is cleared to 0, such as when the power is turned on, make an arrangement so that the moving part of the equipment is in a state of butting against the backlash direction.  
 (Initial state)  
 Otherwise, noise or oscillation may occur during motor operation, depending on the Pr7.06 "Backlash compensation time constant" setting.

## (1) Applicable Range

- This function cannot be applied unless the following conditions are satisfied:

Conditions under which backlash compensation function operates	
Control mode	• Position control
Other	• Software version is function extended edition 3 or higher (Ver1.05 and later)

## (2) Caution

- It is prohibited to change Pr7.05 "Amount of backlash compensation", Pr7.06 "Backlash compensation time constant" and Pr7.04 "Backlash compensation selection" bit 2 during motor operation or command delivery.  
The timing for reflection in case either is changed during motor operation or command delivery is undefined.  
\* Pr7.04 bit2 cannot be used in [A6BE/A6BF]. Fix the value to 0.
  - Changes in bits 1-0 of Pr7.04 "Backlash compensation selection" are reflected at the servo-on timing. .
  - Backlash compensation state is maintained when position control is switched to velocity control or torque control. It will resume from the backlash compensation state in the previous position control when it is switched back to position control again.
  - The actual motor position is the position shifted from the motor position information read via EtherCAT Communication by the amount of backlash compensation (when Pr6.97 bit6=0).
  - The position command is subjected to correction when operation is executed for the first time in the set direction above after servo on. There will be no correction if operation occurs in the opposite direction before that. Correction is also executed in the opposite direction when operation occurs in the opposite direction for the first time after the first backlash compensation. Once backlash compensation is executed, there will be no more correction as long as operation is repeated in the same direction for which backlash compensation was executed once.
  - When Pr7.04 "Backlash compensation selection" bit2=0 and the servo is turned off with the backlash corrected, the backlash compensation amount is cleared by presetting the command position information inside the servo amplifier with the motor position information including the backlash compensation amount. (\*1)  
When servo on occurs again, the backlash compensation operation described above is executed.
  - When Pr7.04 "Backlash compensation selection" bit2=1, the backlash compensation state can be maintained without clearing the backlash compensation amount even if the servo is turned off. If the servo is turned on again, the motor operation can be resumed from the backlash compensation state when the servo was turned on last time.  
\* Pr7.04 bit2 cannot be used in [A6BE/A6BF]. Fix the value to 0.
- (Note) Make sure that the positional relationship between the moving parts of the equipment and the motor is not broken while the server is off. If the positional relationship is broken, noise or oscillation may occur during motor operation after the servo is turned on next time depending on the setting of Pr7.06 "Backlash compensation time constant".

\*1) The conditions for clearing the backlash compensation are shown below.

Conditions for clearing the correction state	
Pr7.04 bit2 = 0 (Conventional specification)	<ul style="list-style-type: none"> <li>• When the servo is turned off</li> <li>• When the ESM status changes to Init</li> <li>• State other than OP if 6040h (Control word) is mapped on PDO</li> <li>• Alarm occurrence</li> <li>• When the safe torque is off (STO)</li> <li>• When the position deviation is cleared</li> <li>• When the servo (MINAS-A6) side decelerates and stops due to over-travel inhibition input</li> </ul>
Pr7.04 bit2 = 1 (expansion specification) *2)	<ul style="list-style-type: none"> <li>• When the ESM status changes to Init</li> </ul>

\*2) It is not supported in the enhanced version 7 or earlier.

- Do not execute position information latch, position information initialization or control mode switching without backlash compensation output completely delivered (states other than “Backlash compensation output 0 or the state of the setting value in Pr7.05”). In addition, be sure to change the above objects related to backlash compensation during servo off.
- Set Pr7.05 "Amount of backlash compensation" and Pr7.06 "Backlash compensation time constant" so that Err27.4 does not occur.  
If Err27.4 occurs, set Pr7.06 "Backlash compensation time constant" to a large value.
- If the moving part is moved by an external force while the servo is off, or if the servo is turned off while the backlash compensation amount is being discharged, the backlash compensation amount will shift. Perform return to origin again.
- You can set a dead zone for the position in the update of the backlash compensation state after the servo is turned on so that Pr7.18 "Backlash compensation amount holding range" prevents backlash compensation from being applied in an unintended direction due to communication delay of the upper (master) side 607Ah.

(Example) When the servo is off and the backlash compensation amount is held for 50 pulses in the positive direction

Conditions) Pr6.97 bit6 "Position information switching" = 0  
 Pr7.04 "Backlash compensation selection" = 5  
 • bit1=0=01b (Corrected when operated in the positive direction)  
 • Bit2=1 (correction state is maintained when the servo is off)  
 Pr7.05 "Backlash compensation amount" = 100 pulses  
 Pr7.06 "Backlash compensation time constant" = Arbitrary  
 Electronic gear ratio 1:1

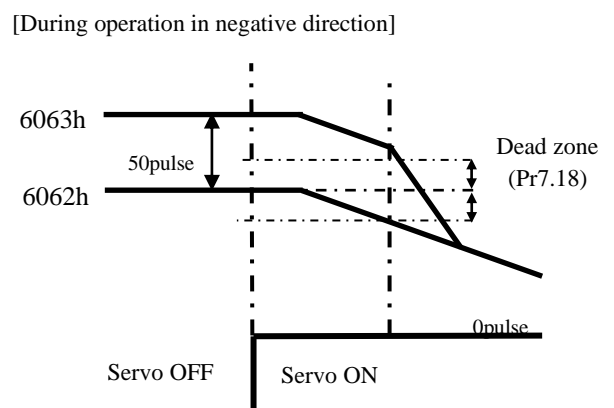
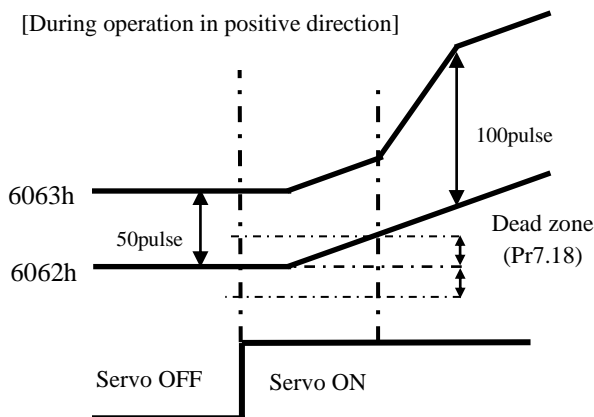

If the relative position (\*1) after the servo is turned on is within the dead zone, the backlash compensation amount of 50 pulses is held.

If the dead zone in the positive direction is exceeded, the correction amount will be 100 pulses.

If the relative position (\*1) after the servo is turned on is within the dead zone, the backlash compensation amount of 50 pulses is held.

If the dead zone is exceeded in the negative direction, the correction amount will be 0 pulse.

\*1)Relative position after servo ON = 6062h during servo ON - 6062h immediately before servo ON

- If the relative position after the servo is turned on (\*1) is within the dead zone, when home position return with motor operation (other than method-35, 37) is executed, home position return is performed with releasing the dead zone state  
If home position return without motor operation (method-35, 37) is executed, home position return will be performed without releasing the dead zone state.

## (3) Related parameters

Class	No.	Attribute *1)	Title	Range	Unit	Function
6	97	B	Function expansion setup 3	-2147483648 ~ 2147483647	—	bit6 : Switching during backlash compensation 0 : 6064h = 6063h(Position Actual Internal Value) - Pr7.05 1 : 6064h = 6063h(Position Actual Internal Value) *6064h is the command unit, 6063h, Pr7.05 is the pulse unit, and the above formula includes conversion by electronic gear.
7	04	B	Backlash compensation selection	0~7	—	Select the backlash compensation for position control. bit1-0:Enable/disable backlash compensation and select operation direction during correction *1) 00b:Disabled 01b:Correct the backlash at the first operation in the positive direction after the servo is turned on. 10b:Correct the backlash at the first operation in the negative direction after the servo is turned on. 11b:Manufacturer specification bit2:Extension of conditions for holding the backlash compensation state *2) 0:Conventional specification 1:Extended specification
7	05	B	Amount of backlash compensation	-1073741824 ~ 1073741823	pulse	Set the amount of backlash (mechanical gap in drive system) compensation during position control.
7	06	B	Backlash compensation time constant	0~6400	0.01ms	Set the time constant for backlash (mechanical gap in drive system) compensation during position control.
7	18	B	Backlash compensation amount holding range	0~ 2147483647	Command unit	Set the dead zone for backlash compensation when the servo status changes from OFF to ON. *2) If 0 is specified for this setting, the function will be disabled. This parameter does not depend on the Pr7.04 bit2 setting.

\*1) It is not supported in versions corresponding to function extended edition 2 or earlier.

\*2) It is not supported in versions corresponding to function extended edition 7 or earlier.

Pr7.04 bit1-0	Pr7.05 value is positive	Pr7.05 value is negative
01b	Corrects in the positive direction during operation in the positive direction	Corrects in the negative direction during operation in the positive direction
10b	Corrects in the positive direction during operation in the negative direction	Corrects in the negative direction during operation in the negative direction

## 7. Protective function/Alarm function

## 7-1 List of protective function

This servo driver incorporates various protective functions. When a protective function is enabled, the servo driver turns OFF the alarm signal (ALM) and displays the error number on 7-segment LED of the panel section at front surface.

However, V frame is not equipped with a 7-segment LED. \*7

Error No.		Alarm	Attribute			
Main	Sub		History	Can be cleared	Emergency stop *6	EtherCAT communication related
11	0	Control power supply undervoltage protection		○		
12	0	Over-voltage protection	○	○		
13	0	Main power supply undervoltage protection (between P to N)		○	○	
	1	Main power supply undervoltage protection (AC interception detection)		○	○	
14	0	Over-current protection	○			
	1	IPM error protection	○			
15	0	Over-heat protection	○		○	
	1	Encoder over-heat error protection	○		○	
16	0	Over-load protection	○	○*1		
	1	Torque saturation error protection	○	○		
18	0	Over-regeneration load protection	○		○	
	1	Regenerative transistor error protection	○			
21	0	Encoder communication disconnect error protection	○			
	1	Encoder communication error protection	○			
23	0	Encoder communication data error protection	○			
24	0	Position deviation excess protection	○	○	○	
	1	Speed deviation excess protection	○	○	○	
25	0	Hybrid deviation excess error protection	○		○	
26	0	Over-speed protection	○	○	○	
	1	2nd over-speed protection	○	○		
27	1	Absolute clear protection	○			
	4	Position command error protection	○	○*10	○	
	6	Operation command contention protection	○	○		
	7	Position information initialization error protection *11	○			
28	0	Pulse regeneration limit protection	○	○	○	
29	1	Counter overflow protection 1	○			
	2	Counter overflow protection 2	○			
31	0	Safety function error protection 1	○			
	2	Safety function error protection 2	○			
33	0	Duplicated input allocation error 1 protection	○			
	1	Duplicated input allocation error 2 protection	○			
	2	Input function number error 1 protection	○			
	3	Input function number error 2 protection	○			
	4	Output function number error 1 protection	○			
	5	Output function number error 2 protection	○			
	8	Latch input allocation error protection	○			
34	0	Software limit protection	○	○		
	1	One revolution absolute working range error	○	○		
36	0-1	EEPROM parameter error protection				
37	0-2	EEPROM check code error protection				
38	0	Over-travel inhibit input protection 1		○		
	1	Over-travel inhibit input protection 2		○		
	2	Over-travel inhibit input protection 3	○			
40	0	Absolute system down error protection	○	○*2		

(To be continued)

Error No		Alarm	Attribute			
Main	Sub		History	Can be cleared	Emergency stop *6	EtherCAT communication related
41	0	Absolute counter over error protection	○			
42	0	Absolute over-speed error protection	○	○*2		
44	0	Absolute single turn counter error protection	○			
45	0	Absolute multi-turn counter error protection	○			
47	0	Absolute status error protection	○			
50	0	External scale connection error protection	○			
	1	External scale communication error protection	○			
	2	External scale communication data error protection	○			
51	0	External scale status error protection 0	○			
	1	External scale status error protection 1	○			
	2	External scale status error protection 2	○			
	3	External scale status error protection 3	○			
	4	External scale status error protection 4	○			
	5	External scale status error protection 5	○			
55	0	A-phase connection error protection	○			
	1	B-phase connection error protection	○			
	2	Z-phase connection error protection	○			
60	0	Motor setting error protection				
70	0	U-phase current detector error protection	○			
	1	W-phase current detector error protection	○			
72	0	Thermal error protection	○			
80	0	ESM unauthorized request error protection	○	○	○	○
	1	ESM undefined request error protection	○	○	○	○
	2	Bootstrap requests error protection	○	○		○
	3	Incomplete PLL error protection	○	○		○
	4	PDO watchdog error protection	○	○	○	○
	6	PLL error protection	○	○	○	○
	7	Synchronization signal error protection	○	○	○	○
81	0	Synchronization cycle error protection	○	○		○
	1	Mailbox error protection	○	○		○
	4	PDO watchdog error protection	○	○		○
	5	DC error protection	○	○		○
	6	SM event mode error protection	○	○		○
	7	SyncManager2/3 error protection	○	○		○
	84	3	Synchronous establishment initialization error protection	○		
85	0	TxPDO assignment error protection	○	○		○
	1	RxPDO assignment error protection	○	○		○
	2	Lost link error protection	○	○	○	○
	3	SII EEPROM error protection	○			○
87	0	Forced alarm input protection		○	○	
	1	Retracting operation completion (I/O)*11	○	*8	○*9	
	2	Retracting operation completion (communication) *11	○	*8	○*9	
	3	Retracting operation error *11	○	*8	○	
88	0	Main power undervoltage protection (AC insulation detection 2)		○	○	○
	1	Control mode setting error protection	○	○	○	○
	2	ESM requirements during operation error protection	○	○	○	○
	3	Improper operation error protection	○		○	○
91	1	Command error protection	○	○		

(To be continued)

Error No		Alarm	Attribute			
Main	Sub		History	Can be cleared	Emergency stop *6	EtherCAT communication related
91	3	Command error protection 2	○	○		
92	0	Encoder data recovery error protection	○			
	1	External scale data recovery error protection	○			
	3	Multi-turn data upper-limit value disagreement error protection	○			
93	2	Parameter setting error protection 2	○			
	3	External scale connection error protection	○			
	5	Parameter setting error protection 4	○			
	8	Parameter setting error protection 6	○			
94	3	Home position return error protection 2	○	○		
95	0-4	Motor automatic recognition error protection				
96	2	Control unit error protection 1	○			
	3	Control unit error protection 2	○			
	4	Control unit error protection 3	○			
	5	Control unit error protection 4	○			
	6	Control unit error protection 5	○			
	7	Control unit error protection 6	○			
	8	Control unit error protection 7	○			
	98	2	Communication hardware error protection 2	○		
3		Communication hardware error protection 3	○			
5		Hardware self-diagnosis abnormality protection 1				
Other		Other error protection	—	—	—	—

- \*1: When Err 16.0 (Over-load protection) is triggered, you can clear it in 10 sec or longer after the error occurs. Recognized as alarm clear command and used for clearing process as the condition becomes ready for process.
- \*2: When Err 40.0 (Absolute system down error protection) or Err 42.0 (Absolute over-speed error protection) occurs, the alarm cannot be cleared until the absolute encoder is reset.
- \*3: If the alarm cannot be cleared occurs, remove the alarm cause, turn OFF power to reset.
- \*4: When clearable alarm other than EtherCAT communication-related error (Err80.\*, Err81.\*, Err85.\*, Err88.\*) is occurred, it will be able to clear the alarm in the following way.
- When an alarm clear input (A-CLR) is OFF, or while not assigning, the alarm clearance was performed from EtherCAT communication or USB communication(PANATERM).
  - The alarm clear input (A-CLR) was changed from OFF to ON.

In the following cases, keep in mind that an alarm clearance is not carried out normally.

Example: The alarm clearance is performed from communication (USB or EtherCAT) when A-CLR is ON.  
In this case, perform an alarm clearance from communication after turning OFF A-CLR.

Please perform the alarm clearance while motor is stopped after ensuring safety.

Please refer to section 8-4 "Clear error (alarm)/Clear warning" of Technical Document "EtherCAT Communication Specifications" (SX-DSV03242) for details of the alarm clear method of than EtherCAT communication-related error (Err80.\*, Err81.\*, Err85.\*, Err88.\*).

- \*5: If the servo driver internal control circuit malfunctions due to excessive noise etc., the display will show as follows:



Immediately turn OFF power.

- \*6: Emergency stop is triggered if Pr 5.10 Sequence at alarm is set to one of 4 to 7 and corresponding alarm is detected. For details, refer to 6-3-4 Sequence at alarm.
- \*7: About EtherCAT communication-related error (Err80.\*, Err81.\*, Err85.\*, Err88.\*), front panel indication or alarm indication of PANATERM is delayed from actual occurrence of alarm.



- \*8: Depending on the Pr6.86 bit 0 to 2 settings, the properties of error clear vary.  
bit 0: Err87.1 (Retracting operation completion (I/O)) alarm clear attribute  
bit 1: Err87.2 (Retracting operation completion (communication)) alarm clear attribute  
bit 2: Err87.3 (Retracting operation error) alarm clear attribute  
0: Unable to clear alarms and 1: Able to clear alarms for all
- \*9: It is an emergency stop alarm according to the attribute, but when the retracting operation activation condition is established, the operation does not conform to Pr5.10 "Sequence at alarm" but it is determined by the retracting operation function, and an alarm is generated after retracting operation completion.  
For details of the retracting operation function, refer to section 6-9.  
It behaves as the emergency stop alarm, for example, in a manner that the fall prevention function in alarms works after retracting operation completion.  
For the fall prevention function in alarms, refer to section 6-3-6-1.
- \*10: In the first edition of the software version (Ver1.01), alarm clearance is unavailable.  
In the function expansion version 1 of the software version (Ver1.02) and later, alarm clearance is available.
- \*11: The first edition of the software version (Ver1.01) does not support it.
- \*12: The deceleration method when an EtherCAT related alarm (Err80.\*, Err81.\*, Err85.\*, Err88.\*) occurs is in accordance with 605Eh (Fault reaction active).  
Change the setting from the shipment value according to the equipment environment.

## 7-2 Details of Protective function

Error No.		Protective function	Causes	Measures
Main	Sub			
11	0	Control power supply undervoltage protection	<p>Voltage between P and N of the converter portion of the control power supply has fallen below the specified value.</p> <ol style="list-style-type: none"> <li>1) Power supply voltage is low. Instantaneous power failure has occurred</li> <li>2) Lack of power capacity...Power supply voltage has fallen down due to inrush current at the main power-on.</li> <li>3) Failure of servo driver (failure of the circuit)</li> </ol>	<p>Measure the voltage between lines of connector and terminal block (L1C-L2C).</p> <ol style="list-style-type: none"> <li>1) Increase the power capacity. Change the power supply.</li> <li>2) Increase the power capacity.</li> <li>3) Replace the driver with a new one.</li> </ol> <p>※For V frame, the voltage between lines P2 and N2 is measured</p>
12	0	Over-voltage protection	<p>Power supply voltage has exceeded the permissible input voltage. = Voltage between P and N of the converter portion of the control power supply has exceeded the specified value. Source voltage is high. Voltage surge due to the phase-advancing capacitor or UPS (Uninterruptible Power Supply) have occurred.</p> <ol style="list-style-type: none"> <li>1) Disconnection of the regeneration discharge resistor</li> <li>2) External regeneration discharge resistor is not appropriate and could not absorb the regeneration energy.</li> <li>3) Failure of servo driver (failure of the circuit)</li> </ol>	<p>Measure the voltage between lines of connector (L1, L2 and L3). Enter correct voltage. Remove a phase advancing capacitor.</p> <ol style="list-style-type: none"> <li>1) Measure the resistance of the external resistor connected between terminal P and B of the driver. Replace the external resistor if the value is <math>\infty</math>.</li> <li>2) Change to the one with specified resistance and wattage.</li> <li>3) Replace the driver with a new one.</li> </ol> <p>※For V frame, the voltage between lines P1 and N1 is measured</p>
13	0	Main power supply undervoltage protection (PN)	<p>Instantaneous power failure has occurred between L1 and L3 for longer period than the preset time with Pr 5.09 (Main power off detecting time) while bit0 of Pr 5.08 (LV trip selection at the main power-off) is set to 1. Or the voltage between P and N of the converter portion of the main power supply has fallen below the specified value during Servo-ON.</p> <p>* When executing an escape operation with the trigger of main power off, Err13.1 does not occur.</p> <ol style="list-style-type: none"> <li>1) Power supply voltage is low. Instantaneous power failure has occurred</li> <li>2) Instantaneous power failure has occurred.</li> <li>3) Lack of power capacity...Power supply voltage has fallen down due to inrush current at the main power-on.</li> <li>4) Phase lack...3-phase input driver has been operated with single phase input.</li> <li>5) Failure of servo driver (failure of the circuit)</li> </ol>	<p>Measure the voltage between lines of connector (L1, L2 and L3).</p> <ol style="list-style-type: none"> <li>1) Increase the power capacity. Change the power supply. Remove the causes of the shutdown of the magnetic contactor or the main power supply, then re-enter the power.</li> <li>2) Set up the longer time to Pr 5.09 (Main power off detecting time). Set up each phase of the power correctly.</li> <li>3) Increase the power capacity. For the capacity, refer to Specifications Standard specifications Driver and List of Applicable Peripheral Equipments” of Preparation.</li> <li>4) Connect each phase of the power supply (L1, L2 and L3) correctly. For single phase, 100 V and 200 V driver, use L1 and L3.</li> <li>5) Replace the driver with a new one.</li> </ol> <p>※For V frame, the voltage between lines P1 and N1 is measured</p>
	1	Main power supply undervoltage protection (AC)		
14	0	Over-current protection	<p>Current through the converter portion has exceeded the specified value.</p> <ol style="list-style-type: none"> <li>1) Failure of servo driver (failure of the circuit, IGBT or other components)</li> <li>2) Short of the motor wire (U, V and W)</li> <li>3) Earth fault of the motor wire</li> <li>4) Burnout of the motor</li> <li>5) Poor contact of the motor wire.</li> </ol>	<ol style="list-style-type: none"> <li>1) Turn to Servo-ON, while disconnecting the motor. If error occurs immediately, replace with a new driver.</li> <li>2) Check that the motor wire (U, V and W) is not shorted, and check the branched out wire out of the connector. Make a correct wiring connection.</li> <li>3) Measure the insulation resistance between motor wires, U, V and W and earth wire. In case of poor insulation, replace the motor.</li> <li>4) Check the balance of resistor between each motor line, and if unbalance is found, replace the motor.</li> <li>5) Check the loose connectors. If they are, or pulled out, fix them securely.</li> <li>6) Replace the servo driver. Do not use servo ON/OFF during operation.</li> <li>7) Enter the commands 100 ms or longer after Servo-ON.</li> <li>8) Replace the driver.</li> </ol>
	1	IPM error protection (IPM: Intelligent Power Module)	<ol style="list-style-type: none"> <li>6) Welding of relay contact for dynamic braking due to frequent servo ON/OFF operations.</li> <li>7) Timing of command input is same as or earlier than Servo-ON.</li> <li>8) The dynamic brake circuit was overheated and the thermal fuse is blown. (Only E-frame and F-frame)</li> </ol>	

(To be continued)

Error No.		Protective function	Causes	Measures
Main	Sub			
15	0	Over-heat protection	Temperature of the heat sink or power device has been risen over the specified temperature. 1) Ambient temperature has risen over the specified temperature. 2) Over-load	Check the operating temperature range of the servo driver. 1) Improve the ambient temperature and cooling condition. 2) Increase the capacity of the driver and motor. Set up longer acceleration/ deceleration time. Lower the load.
	1	Encoder over-heat error protection	The temperature of the encoder reaches the encoder overheat error level or higher. 1) The ambient temperature of the servo motor is high. 2) Use with an overload	1) Improve the ambient temperature and cooling conditions of the servo motor. 2) Increase the capacity of the servo driver and motor. Set a longer acceleration/deceleration time. Reduce the load.
16	0	Over-load protection	Torque command value has exceeded the over-load level set with Pr 5.12 (Setup of over-load level) and resulted in overload protection according to the time characteristics (described later). 1) Load was heavy and actual torque has exceeded the rated torque and kept running for a long time. 2) Oscillation and hunching action due to poor adjustment of gain. Motor vibration, abnormal noise. Inertia ratio (Pr 0.04) setup error. 3) Miswiring, disconnection of the motor. 4) Machine has collided or the load has gotten heavy. Machine has been distorted. 5) Electromagnetic brake has been kept engaged. 6) While wiring multiple axes, miswiring has occurred by connecting the motor cable to other axis. 7) Pr5.12 "Over-load level setup" is too low.	Check that the torque (current) does not oscillates nor fluctuate up and down very much on the graphic screen of the network. Check the over-load alarm display and load factor with the network. 1) Increase the capacity of the servo driver and motor. Set up longer acceleration/ deceleration time. Lower the load. 2) Make a re-adjustment of gain. 3) Make a wiring as per the wiring diagram. Replace the cables. 4) Remove the cause of distortion. Lower the load. 5) Measure the voltage between brake terminals. Release the brake 6) Make a correct wiring by matching the correct motor and encoder wires. 7) Set Pr5.12 "Over-load level setup" to 0 (Set the maximum value allowed for the motor).
	1	Torque saturation error protection	Torque saturated has continued for the period set to Pr 7.16 "Torque saturation error protection frequency" or Pr6.57 "Torque saturation error protection detection time".	<ul style="list-style-type: none"> <li>• Check the operating state of the driver.</li> <li>• Take the same measure as done against Err16.0.</li> </ul>
18	0	Over-regeneration load protection	Regenerative energy has exceeded the capacity of regenerative resistor. 1) Due to the regenerative energy during deceleration caused by a large load inertia, converter voltage has risen, and the voltage is risen further due to the lack of capacity of absorbing this energy of the regeneration discharge resistor. 2) Regenerative energy has not been absorbed in the specified time due to a high motor rotational speed. 3) Active limit of the external regenerative resistor has been limited to 10% duty.	Check the load factor of the regenerative resistor from the front panel or via communication. Do not use in the continuous regenerative brake application. 1) Check the running pattern (speed monitor). Check the load factor of the regenerative resistor and over-regeneration warning display. Increase the capacity of the driver and the motor, and loosen the deceleration time. Use the external regenerative resistor. 2) Check the running pattern (speed monitor). Check the load factor of the regenerative resistor. Increase the capacity of the driver and the motor, and loosen the deceleration time. Lower the motor rotational speed. Use an external regenerative resistor. 3) Set up Pr 0.16 to 2.
	1	Regenerative transistor error protection	Regenerative driver transistor on the servo driver is defective.	Replace the driver.

(To be continued)

Error No.		Protective function	Causes	Measures
Main	Sub			
21	0	Encoder communication disconnection error protection	Communication between the encoder and the driver has been interrupted in certain times, and disconnection detecting function has been triggered.	Make a wiring connection of the encoder as per the wiring diagram. Correct the miswiring of the connector pins.
	1	Encoder communication error protection	Communication error has occurred in data from the encoder. Mainly data error due to noise. Encoder cables are connected, but communication data has some errors.	<ul style="list-style-type: none"> <li>Secure the power supply for the encoder of 5 VDC <math>\pm</math>5% (4.75 to 5.25 V)...pay an attention especially when the encoder cables are long.</li> <li>Separate the encoder cable and the motor cable if they are bound together.</li> <li>Connect the shield to FG.</li> </ul>
23	0	Encoder communication data error protection	Data communication between the encoder is normal, but contents of data are not correct. Mainly data error due to noise. Encoder cables are connected, but communication data has some errors.	<ul style="list-style-type: none"> <li>Secure the power supply for the encoder of 5 VDC <math>\pm</math>5% (4.75 to 5.25 V)...pay an attention especially when the encoder cables are long.</li> <li>Separate the encoder cable and the motor cable if they are bound together.</li> <li>Connect the shield to FG.</li> </ul>
24	0	Position deviation excess protection	Deviation pulses have exceeded the setup of Pr 0.14. 1) The motor movement has not followed the command.  2) Setup value of Pr 0.14 (Position deviation excess setup) is small.	1) Check that the motor follows to the position command pulses. Check that the output torque has not saturated in torque monitor. Make a gain adjustment. Set up maximum value to Pr 0.13 and Pr 5.22. Make a encoder wiring as per the wiring diagram. Set up the longer acceleration/deceleration time. Lower the load and speed. 2) Set up a larger value to Pr 0.14.
	1	Speed deviation excess protection	The difference between the internal positional command speed and actual speed (speed deviation) exceeds the setup value of Pr 6.02(Speed deviation excess setup). Note: If the internal positional command speed is forcibly set to 0 due to instantaneous stop caused by the positive/negative over-travel inhibit input, the speed deviation rapidly increases at this moment. Pr 6.02 setup value should have sufficient margin because the speed deviation also largely increases on the rising edge of the internal positional command speed.	<ul style="list-style-type: none"> <li>Increase the setup value of Pr 6.02.</li> <li>Lengthen the acceleration/deceleration time of internal positional command speed, or improve the follow-up characteristic by adjusting the gain.</li> <li>Disable the excess speed deviation detection (Pr 6.02 = 0).</li> </ul>
25	0	Hybrid deviation excess error protection	Position of load by the external scale and position of the motor by the encoder slips larger than the setup pulses with Pr 3.28 (Setup of hybrid deviation excess) at fullclosed control.	<ul style="list-style-type: none"> <li>Check the connection between the motor and the load.</li> <li>Check the connection between the external scale and the driver.</li> <li>Check that the variation of the motor position (encoder feedback value) and the load position (external scale feedback value) is the same sign when you move the load.</li> </ul> Check that the numerator and denominator of the external scale division (Pr 3.24 and 3.25) and reversal of external scale direction (Pr 3.26) are correctly set.
26	0	Over-speed protection	The motor rotational speed has exceeded the setup value of Pr 5.13.	<ul style="list-style-type: none"> <li>Do not give an excessive speed command.</li> <li>Check the command pulse input frequency and division/multiplication ratio.</li> </ul>
	1	2nd over-speed protection	The motor rotational speed has exceeded the setup value of Pr 6.15.	<ul style="list-style-type: none"> <li>Make a gain adjustment when an overshoot has occurred due to a poor gain adjustment.</li> <li>Make a wiring connection of the encoder as per the wiring diagram.</li> </ul>

(To be continued)

Error No.		Protective function	Causes	Measures
Main	Sub			
27	1	Absolute clear protection	Multi-turn clear of absolute encoder is made through USB communication (PANATERM).	<ul style="list-style-type: none"> <li>Check if multi-turn clear of absolute encoder has been made through USB communication.</li> </ul> Note: Checking is for the purpose of safety and not the cause of error.
	4	Position command error protection	Position command variation (value after electronic gear) exceeds the specified value.	<ul style="list-style-type: none"> <li>Check whether the variation is not large, such as the position command operation by the cyclic synchronous position control (csp).</li> <li>Check electronic gear ratio.</li> <li>Alarm clearance is available in the function expansion version 1 of the software version (Ver1.02) and later. Because return to origin is incomplete after Err27.4 occurrence, implement return to origin again after alarm clearance.</li> </ul>
	6	Operation command contention protection	<ul style="list-style-type: none"> <li>When Pr7.99 bit0=0 is set, EtherCAT communications established during test run or FFT operating.</li> <li>When Pr7.99 bit0=1 is set, servo ON command by EtherCAT communications received during test run or FFT operating.</li> </ul>	<ul style="list-style-type: none"> <li>Check that EtherCAT has not been established during test run or FFT when Pr7.99 bit0=0 is set.</li> <li>Check that servo ON command by EtherCAT communication has not been sent from the host controller during test run or FFT when Pr7.99 bit0=1 is set.</li> </ul>
	7	Position information initialization error protection	<ul style="list-style-type: none"> <li>In the hm mode, return to origin has been canceled by halt from the host device between origin detection and return to origin completion.</li> </ul> (Note) The first edition of the software version(Ver1.01) does not support this.	<ul style="list-style-type: none"> <li>Check if homing command is canceled near the home position signal.</li> </ul>
28	0	Pulse regeneration limit protection	The output frequency of pulse regeneration has exceeded the limit.	<ul style="list-style-type: none"> <li>Check the setup value of Pr0.11 (Output pulse counts per motor revolution) and Pr5.03 (Denominator of pulse output division).</li> <li>To disable the detection, set Pr5.33 (Pulse regenerative output limit setup) to 0.</li> </ul>
29	1	Counter overflow protection 1	The calculation value (the absolute encoder (or the absolute external scale) position information [pulse] / electronic gear ratio) has exceeded 32bit width or an overflow occurred during the calculation, when the control power is ON in absolute mode, EtherCAT communication is established (Init -> PreOp), returning to origin is completed, the absolute multi-turn data is cleared, PANATERM operation (test run, frequency characteristic analysis, Z phase search, fit gain) is completed, or pin assign is excuted by PANATERM.	<ul style="list-style-type: none"> <li>Check the operation range at the position of absolute encoder (absolute scale) and electronic gear ratio.</li> </ul>
	2	Counter overflow protection 2	Position deviation (pulse unit) became $\pm (2^{30} - 1)$ (1073741823) or more. Or the position deviation (command unit) exceeds $\pm 2^{30}$ (1073741824).	<ul style="list-style-type: none"> <li>Check that the motor runs as per the position command pulses.</li> <li>Check that the output toque has not saturated in torque monitor.</li> <li>Make a gain adjustment.</li> <li>Set up maximum value to torque limit setting.</li> <li>Make a wiring connection of the encoder as per the wiring diagram.</li> </ul>
31	0	Safety function error protection 1	Safety function has detected an error.	<ul style="list-style-type: none"> <li>In case of the repeated occurrence, because failure is possible, replace the servo driver. Return to a dealer for investigation (repair).</li> </ul>
	2	Safety function error protection 2		

(To be continued)

Error No.		Protective function	Causes	Measures
Main	Sub			
33	0	Duplicated input allocation error 1 protection	Input signals (SI1, SI2, SI3, SI4) are assigned with two functions.	Allocate correct function to each connector pin.
	1	Duplicated input allocation error 2 protection	Input signals (SI5, SI6, SI7, SI8) are assigned with two functions.	Allocate correct function to each connector pin.
	2	Input function number error 1 protection	Input signals (SI1, SI2, SI3, SI4) are assigned with undefined number. Or, logical setup is not correct.	Allocate correct function to each connector pin.
	3	Input function number error 2 protection	Input signals (SI5, SI6, SI7, SI8) are assigned with undefined number. Or, logical setup is not correct.	Allocate correct function to each connector pin.
	4	Output function number error 1 protection	Output signals (SO1) are assigned with undefined number.	Allocate correct function to each connector pin.
	5	Output function number error 2 protection	Output signals (SO2, SO3) are assigned with undefined number.	Allocate correct function to each connector pin.
	8	Latch input allocation error protection	Error has occurred during function assignment of latch correction pins (SI5, SI6, and SI7). <ul style="list-style-type: none"> <li>EXT1 must be allocated to SI5 and EXT2 to SI6: but these are assigned to other pins.</li> <li>HOME is allocated to SI6 or SI7; POT is allocated to SI5 or SI7; NOT is allocated to SI5 or SI6.</li> <li>Function not allocated to all control modes.</li> </ul>	Allocate correct function to each connector pin.
34	0	Software limit protection	When a position command within the specified input range is given, the motor operates outside its working range specified in Pr 5.14 (Motor working range setup). 1) Gain is not appropriate. 2) Pr 5.14 setup value is low.	1) Check the gain (balance between position loop gain and velocity loop gain) and inertia ratio. 2) Increase the setup value of Pr 5.14. Or, Set Pr 5.14 to 0 to disable the protective function.
	1	One revolution absolute working range error	At the time of absolute encoder is used, When Pr0.15 (Absolute encoder setup)=3, the motor (encoder) position or command position crossed motor working range (encoder 1 revolution data).	<ul style="list-style-type: none"> <li>Check the working range of an absolute encoder (absolute scale) position including 607Ch (Home offset).</li> <li>Reconsider electronic gear ratio.</li> <li>A motor (encoder) position is returned in motor working range (inside of encoder 1 revolution data).</li> <li>A command position is returned in motor working range (inside of encoder 1 revolution data).</li> </ul>
36	0	EEPROM parameter error protection	Data in parameter storage area has been damaged when reading the data from EEPROM at power-on.	<ul style="list-style-type: none"> <li>Set up all parameters again.</li> <li>If the error persists, replace the driver (it may be a failure.)</li> <li>Return the product to the dealer or manufacturer.</li> </ul>
	1			
37	0	EEPROM check code error protection	Data for writing confirmation to EEPROM has been damaged when reading the data from EEPROM at power-on.	<ul style="list-style-type: none"> <li>Replace the driver. (it may be a failure).</li> <li>Return the product to the dealer or manufacturer.</li> </ul>
	1			
	2			
38	0	Over-travel inhibit input protection 1	With Pr 5.04, over-travel inhibit input setup = 0, both positive and negative over-travel inhibit inputs (POT/NOT) have been ON. With Pr 5.04 = 2, positive or negative over-travel inhibit input has turned ON.	Check that there are not any errors in switches, wires or power supply which are connected to positive direction/ negative direction over-travel inhibit input. Check that the rising time of the control power supply (12 to 24 VDC) is not slow.
	1	Over-travel inhibit input protection 2	An operation command (e.g. test run, FFT) has been received through USB communication (PANATERM) while EtherCAT communication is OFF with Pr 5.04 "over-travel inhibition input setting" = 0 or 1, and either POT or NOT is ON. Or, POT or NOT is turned ON while the system is operating according to the command given through USB communication.	Check that there are not any errors in switches, wires or power supply which are connected to positive direction/ negative direction over-travel inhibit input. Check that the rising time of the control power supply (12 to 24 VDC) is not slow.
	2	Over-travel inhibit input protection 3	With POT allocated to SI6 or NOT to SI7, Pr 5.04 "Over-travel inhibit input setup" is set to a value other than 1 (CoE side deceleration stop).	<ul style="list-style-type: none"> <li>When POT is allocated to SI6 or NOT allocated to SI7, make sure that Pr 5.04 "Over-travel inhibit input setup" is set to 1 (CoE side deceleration stop).</li> </ul>

(To be continued)

Error No.		Protective function	Causes	Measures
Main	Sub			
40	0	Absolute system down error protection	Voltage of the built-in capacitor has fallen below the specified value because the power supply or battery for the absolute encoder has been down. The absolute encoder has not been cleared even once by the batteryless absolute encoder.	After connecting the battery for absolute data, clear the absolute encoder with battery. Clear the batteryless absolute encoder. The alarm cannot be cleared until the absolute encoder is reset.
41	0	Absolute counter over error protection	Multi-turn counter of absolute encoder has exceeded the specified value.	<ul style="list-style-type: none"> <li>Set Pr 0.15 Absolute encoder setup to the appropriate value.</li> <li>Limit the travel from the machine origin within 32767 revolutions.</li> <li>Clear the multiple rotation of absolute encoder.</li> </ul>
42	0	Absolute over-speed error protection	When using absolute encoder 1)The motor speed has exceeded the specified value when only the supply from the battery has been supplied to encoder during the power failure. 2) The encoder power supply was shut down for some reason during normal operation and the rotation speed exceeded the specified value. Note: It does not occur in the batteryless absolute encoder.	1) At the time of power failure, confirm the presence or absence of driving from the outside and the rotation speed at that time, and operate so as to be less than the specified value. 2) Since switching to power failure mode during normal operation <ul style="list-style-type: none"> <li>Check the supply voltage at the encoder side (5 V <math>\pm</math>5%)</li> <li>Check the connecting condition of the connector, CN X6.</li> </ul> The alarm cannot be cleared until the absolute encoder is reset.
44	0	Absolute single turn counter error protection	Single turn counter error of absolute encoder has been detected.	Replace the motor.
45	0	Absolute multi-turn counter error protection	Multi turn counter error of absolute encoder has been detected.	Replace the motor.
47	0	Absolute status error protection	Encoder has been running at faster speed than the specified value at power on.	Arrange so as the motor does not run at power-on.
50	0	External scale connection error protection	Communication between the external scale and the driver has been interrupted in certain times, and disconnection detecting function has been triggered.	<ul style="list-style-type: none"> <li>Make a wiring connection of the external scale as per the wiring diagram.</li> <li>Correct the miswiring of the connector pins.</li> </ul>
	1	External scale communication error protection	Communication error has occurred in data from the external scale. Mainly data error due to noise. External scale cables are connected, but communication data has some error.	<ul style="list-style-type: none"> <li>Secure the power supply for the external scale of 5 VDC <math>\pm</math>5% (4.75 to 5.25 V)...pay attention especially when the external scale cables are long.</li> <li>Separate the external scale cable and the motor cable if they are bound together.</li> </ul>
	2	External scale communication data error protection	The data from the external scale was not a communication error, but the contents of the data became an error. Data error mainly caused by noise. External scale connecting cable was connected, but communication data became an error.	<ul style="list-style-type: none"> <li>Connect the shield to FG...refer to wiring diagram of external scale in Specifications.</li> </ul>
51	0	External scale status error protection 0	Bit 0 of the external scale error code (ALMC) has been turned to 1. Check the specifications of the external scale.	After removing the cause of the error, clear the external scale error. And then, shut off the power to reset.
	1	External scale status error protection 1	Bit 1 of the external scale error code (ALMC) has been turned to 1. Check the specifications of the external scale.	
	2	External scale status error protection 2	Bit 2 of the external scale error code (ALMC) has been turned to 1. Check the specifications of the external scale.	
	3	External scale status error protection 3	Bit 3 of the external scale error code (ALMC) has been turned to 1. Check the specifications of the external scale.	
	4	External scale status error protection 4	Bit 4 of the external scale error code (ALMC) has been turned to 1. Check the specifications of the external scale.	
	5	External scale status error protection 5	Bit 5 of the external scale error code (ALMC) has been turned to 1. Check the specifications of the external scale.	

(To be continued)

Error No.		Protective function	Causes	Measures
Main	Sub			
55	0	A-phase connection error protection	A-phase connection in the external scale is defective, e.g. discontinued.	Check the A-phase connection of external scale.
	1	B-phase connection error protection	B-phase connection in the external scale is defective, e.g. discontinued.	Check the B-phase connection of external scale.
	2	Z-phase connection error protection	Z-phase connection in the external scale is defective, e.g. discontinued.	Check the Z-phase connection of external scale.
60	0	Motor setting error protection	0 was set in Pr9.01 "External scale resolution" when Pr0.01 "Control mode selection"=6 and Pr3.23 "External scale type selection"=6 were set. (Note) It is not supported in function extended edition 2 and earlier versions.	Check the setting in Pr9.01 "External scale resolution" again.
70	0	U-phase current detector error protection	U-phase current detection offset value has some error.	<ul style="list-style-type: none"> <li>• Turn off power once, and turn on again.</li> <li>• Even so, if an error indication appears and an error occurs, failure is possible. Discontinue the use and replace the motor and servo driver.</li> <li>Return to a dealer for investigation (repair).</li> </ul>
	1	W-phase current detector error protection	W-phase current detection offset value has some error.	
72	0	Thermal error protection	Thermal has some error.	
80	0	ESM unauthorized request error protection	The change state request which cannot change from the present state was received. Init to SafeOP Init to OP PreOP to OP OP to Bootstrap PreOP to Bootstrap SafeOP to Bootstrap	Check the change state request of host controller.
	1	ESM undefined request error protection	The change state request which does not have a definition (except the following) was received. 1 : Request Init State 2 : Request Pre-Operational State 3 : Request Bootstrap State 4 : Request Safe-Operational State 8 : Request Operational State	Check the change state request of host controller.
	2	Bootstrap requests error protection	The following change state request was received. 3 : Request Bootstrap State	Check the change state request of host controller.
	3	Incomplete PLL error protection	Phasing servo and communication (PLL lock) could not be completed even after the lapse of 1s after the start of the synchronization process.  When Pr7.110 bit8 is 1, more than the threshold value that the omission of the interruption processing by SYNC0 or IRQ set up by bit0-3 of Pr7.42 (Maximum continuation communication error) in after the completion of synchronous processing generated.	<p>&lt;In case of DC&gt;</p> <ul style="list-style-type: none"> <li>- Check setting of DC mode.</li> <li>- It is checked whether propagation delay compensation or drift compensation is correct.</li> </ul> <p>&lt;In case of SM2&gt;</p> <ul style="list-style-type: none"> <li>- It is checked whether the transmitting timing of PDO from host controller is constant.</li> <li>- Please check whether there is any problem in wiring of the EtherCAT communication cable.</li> <li>- Please check whether the excessive noise has started the EtherCAT communication cable.</li> <li>- The preset value of Pr7.42 (Maximum continuation communication error) bit0-3 is enlarged.</li> <li>- If the error cannot be resolved, shut off and reset the control power.</li> </ul>
	4	PDO watchdog error protection	During PDO communication (SafeOP or OP state), bit10 of AL Event Request(0220h) did not turn on within the time is set ESC register addresses 0400h and 0420h.	<ul style="list-style-type: none"> <li>- Check whether the transmitting timing of PDO from host controller is constant (not stop).</li> <li>- Increase the timeout value of the PDO watchdog detection.</li> <li>- Check whether there is any problem in wiring of the EtherCAT telecommunication cable.</li> <li>- Check whether the excessive noise has started the EtherCAT communication cable.</li> </ul>

(To be continued)



Error No.		Protective function	Causes	Measures
Main	Sub			
80	6	PLL error protection	In the ESM state is SafeOP or OP, phasing servo and communication (PLL lock) was separated.	<p>&lt;In case of DC&gt;</p> <ul style="list-style-type: none"> <li>- Check setting of DC mode.</li> <li>- Check whether propagation delay compensation or drift compensation is correct.</li> </ul> <p>&lt;In case of SM2&gt;</p> <ul style="list-style-type: none"> <li>- Check whether the transmitting timing of PDO from host controller is constant.</li> <li>- Check whether there is any problem in wiring of the EtherCAT communication cable.</li> <li>- Check whether the excessive noise has started the EtherCAT communication cable.</li> </ul> <p>- If the error cannot be resolved, shut off and reset the control power.</p>
	7	Synchronization signal error protection	More than the threshold value that the omission of the interruption processing by SYNC0 or IRQ set up by bit0-3 of Pr7.42 (Maximum continuation communication error) in after the completion of synchronous processing generated.	<p>&lt;In case of DC&gt;</p> <ul style="list-style-type: none"> <li>- Check setting of DC mode.</li> <li>- Check whether propagation delay compensation or drift compensation is correct.</li> </ul> <p>&lt;In case of SM2&gt;</p> <ul style="list-style-type: none"> <li>- Check whether the transmitting timing of PDO from host controller is constant.</li> <li>- Check whether there is any problem in wiring of the EtherCAT communication cable.</li> <li>- Check whether the excessive noise has started the EtherCAT communication cable.</li> <li>- The preset value of Pr7.42 (Maximum continuation communication error) bit0-3 is enlarged.</li> </ul> <p>- If the error cannot be resolved, shut off and reset the control power.</p>
81	0	Synchronization cycle error protection	<p>It is set to an unsupported synchronization cycle (SYNC0 cycle or an IRQ cycle).</p> <ul style="list-style-type: none"> <li>- It sets except 125000, 250000, 500000, 1000000, 2000000, and 4000000 [ns] to ESC register SYNC0 Cycle Time (09A0h) and object 1C32h-02h (Cycle time).</li> <li>- The setting of ESC register and object is not in agreement.</li> </ul>	<ul style="list-style-type: none"> <li>- Please set up a synchronous period correctly.</li> </ul>
	1	Mailbox error protection	<p>Mailbox SyncManager 0/1 setting is wrong.</p> <ul style="list-style-type: none"> <li>- A Physical Start Address:ESC register (0800h, 0801h/0808h, 0809h) setup of SyncManager0/1 is inaccurate.</li> <li>- The area for reception of Mailbox overlaps the area for transmission.</li> <li>- The area for transmission/reception of Mailbox overlaps the area for transmission/reception of SyncManager2/3</li> <li>- Address specification of the area for transmission/reception of Mailbox is odd number.</li> <li>- A Length:ESC register (0802h,0803h/080Ah, 080Bh) setup of SyncManager0/1 is inaccurate.</li> <li>- SyncManager0: Less than 32 byte</li> <li>- SyncManager1: Less than 32 byte</li> <li>- A Control Register:ESC register (0804h/080Ch) setup of SyncManager0/1 is inaccurate.</li> <li>- Other than 0110b is set for 0804h: bit3-0.</li> <li>- Other than 0010b is set for 080Ch: bit3-0.</li> </ul>	<ul style="list-style-type: none"> <li>- Please set up Sync manager correctly.</li> </ul>

(To be continued)

Error No.		Protective function	Causes	Measures
Main	Sub			
81	4	PDO watchdog error protection	A setup of the watchdog timer of PDO is wrong. - Although PDO watch dog trigger is effective (SyncManager: Bit6 which is the register 0804h set to 1), When the detection timeout value of PDO watchdog timer cycle setup (registers 0400h and 0420h) was the "communication cycle multiply 2" by DC and SM2 mode, was the following was set as less than 2 ms by FreeRun mode.	- Set up detection timeout value of watchdog timer correctly.
	5	DC error protection	DC setting setup is wrong. - A value other than the following was set to bit 2-0 of 0981h (Activation) of the ESC register: bit 2-0 = 000b bit 2-0 = 011b	- Check setting of DC mode.
	6	SM event mode error protection	SM event mode which is not supported was set up. - It was set to 1C32h-01h(Sync mode) at values other than 00h(FreeRun), 01h(SM2), and 02h(DC SYNC0). - A value other than 00h (FreeRun), 02h (DC SYNC0), or 22h (SM2) was set to 1C33h-01h (Sync mode). - 000b was set to bit 2-0 of 0981h of the ESC register and SM2 was set to only either 1C32h-01h or 1C33h-01h.	- 1C32h-01h(Sync mode) should set up 00h(FreeRun), 01h(SM2), or 02h(DC SYNC0). - 1C33h-01h(Sync mode) should set up 00h (FreeRun), 02h (DC SYNC0), or 22h (SM2). - The setting of 1C32h-01h should be equal to that of 1C33h-01h.
	6	SM event mode error protection	SM event mode which is not supported was set up. - It was set to 1C32h-01h(Sync mode) at values other than 00h(FreeRun), 01h(SM2), and 02h(DC SYNC0). - A value other than 00h (FreeRun), 02h (DC SYNC0), or 22h (SM2) was set to 1C33h-01h (Sync mode). - 000b was set to bit 2-0 of 0981h of the ESC register and SM2 was set to only either 1C32h-01h or 1C33h-01h.	- 1C32h-01h(Sync mode) should set up 00h(FreeRun), 01h(SM2), or 02h(DC SYNC0). - 1C33h-01h(Sync mode) should set up 00h (FreeRun), 02h (DC SYNC0), or 22h (SM2). - The setting of 1C32h-01h should be equal to that of 1C33h-01h.
	7	SyncManager2/3 error protection	A setup of SyncManager2/3 was set as the unjust value. - A Physical Start Address (ESC registersh 0810h) setting of SyncManager2 is inaccurate. - The area for reception overlaps the area for transmission. - The area for transmission/reception of Mailbox overlaps the area for transmission/reception of SyncManager2/3 - Address specification of the area for transmission/reception is odd number. - The start address is out of range. - A Length (ESC registersh 0812h) setting of SyncManager2 is inaccurate. - Different from RxPDO size. - A Control Register:ESC register (0814h) setting of SyncManager2 is inaccurate. - Other than 01b is set for bit3-2. - A Physical Start Address (ESC registersh 0818h ) setting of SyncManager3 is inaccurate. - The area for reception overlaps the area for transmission. - The area for transmission/reception of Mailbox overlaps the area for transmission/reception of SyncManager2/3 - Address specification of the area for transmission/reception is odd number. - The start address is out of range. - A Length (ESC register 081Ah) setting of SyncManager3 is inaccurate. - Different from TxPDO size. - A Control Register:ESC register (081Ch) setting of SyncManager3 is inaccurate. - Other than 00b is set for bit3-2.	- Set up SyncManager2/3 correctly.
84	3	Synchronous establishment initialization error protection	Error occurred during initialization process of phasing communication and servo.	<ul style="list-style-type: none"> <li>• Turn off the power once, then re-enter.</li> <li>• If error repeats, this might be a failure. Stop using the products, and replace the motor and the driver.</li> <li>• Return the products to the dealer or manufacturer.</li> </ul>

(To be continued)

Error No.		Protective function	Causes	Measures
Main	Sub			
85	0	TxPDO assignment error protection	- When the data size of the TxPDO map is set up exceeding 32 bytes.	- TxPDO data size is set up within 32 bytes.
	1	RxPDO assignment error protection	- When the data size of the RxPDO map is set up exceeding 32 bytes.	- RxPDO data size is set up within 32 bytes.
	2	Lost link error protection	The time set in Pr7.43 (Lost link detection time) elapsed when either Port 0 or Port 1 fell and remains in the lost link state after the ESM state transitioned from Init to PreOP (not including a port that had been in the lost link state at the time of transition from Init to PreOP).	- Check whether there is any problem in wiring of EtherCAT communication cable. - Check whether there is any problem in the communication from higher rank equipment.
	3	SII EEPROM error protection	- VendorID, Product code, and Revision number do not agree between SII (EEPROM) and the object values. - Reading out from and writing to SII (EEPROM) are improper. - If any of bit11 to14 of ESC register 0502h is set to 1.	- Check the data of SII. - Retry reading out from and writing to SII.
87	0	Forced alarm input protection	Forced alarm input (E-STOP) is applied.	Check the wiring of forced alarm input (E-STOP).
	1	Retracting operation completion (I/O)	The retracting operation by I/O is successfully completed. (Note) The first edition of the software version (Ver1.01) does not support this.	- This is a security precaution, and there is no problem if it is an intended retracting operation. - It is an error that notifies the retracting operation execution. - Make sure that return to origin is performed after the alarm is cleared.
	2	Retracting operation completion (communication)	The retracting operation by communication is successfully completed. (Note) The first edition of the software version (Ver1.01) does not support this.	- Check whether there is any problem in wiring of EtherCAT communication cable. - Check whether there is any problem in the communication from higher rank equipment.
	3	Retracting operation error	Retracting operation activation failed due to one of the following conditions. Otherwise, the retracting operation was suspended. - The setting for Pr6.85 "Retracting operation condition setting" is abnormal - The retracting operation is enabled and the communication cycle is less than 0.250 ms - Drive inhibit input (POT/NOT) is detected during the retracting operation - A retracting operation execution condition is satisfied although drive inhibit input (POT/NOT) has been detected - A retracting operation execution condition is satisfied during an operation not according to the communication command from the host device (such as test run) - The retracting operation was suspended in response to alarm detection during a retracting operation - Retracting operation activation failed due to a servo-off state and such  (Note) The first edition of the software version (Ver1.01) does not support this.	- Confirm that there are no errors in parameter settings. - Confirm that there is no problem in the operating environment. - Make sure that return to origin is performed after the alarm is cleared.

(To be continued)

Error No.		Protective function	Causes	Measures
Main	Sub			
88	0	Main power undervoltage protection (AC insulation detection 2)	<ul style="list-style-type: none"> <li>- Main circuit power supply OFF was detected when the preset value of 6007h (Abort connection option code) is 1 and the PDS state is "Operation Enabled" or "Quick stop active".</li> <li>- Switch on command was received when the preset value of 6007h (Abort connection option code) is 1 and the PDS state is "Ready to switch on" and main circuit power supply OFF.</li> </ul>	<ul style="list-style-type: none"> <li>- The capacity rise of power supply voltage. A power supply is changed. The cause by which the magnetic contactor of the main power supply fell is removed, and a power supply is switched on again.</li> <li>- Each phase (L1, L2, L3) of a power supply is connected correctly. The single phase 100V and the single phase 200V should use L1 and L3.</li> <li>- It replaces with new servo driver.</li> </ul>
	1	Control mode setting error protection	<ul style="list-style-type: none"> <li>- The PDS state was changed to "Operation enabled" when the value set to 6060h (Modes of operation) is 0 and the value set to 6061h (Modes of operation display) is 0.</li> <li>- Control modes not supported by 6060h (Modes of operation) were set.</li> <li>- 3 (pv), 4 (tq), 9(csv) or 10 (cst) is set to 6060h (Modes of operation) in full-closed control mode.</li> <li>- 4 (tq) or 10 (cst) is set to 6060h (Modes of operation) in two-degree-of-freedom control mode (standard type). (Note) It occurs in function extended edition 2 and earlier versions.</li> <li>- 3 (pv) or 9(csv) is set for 6060h (Modes of operation) in two-degree-of-freedom control mode (Synchronization type). (Note) It occurs when 4 (tq) or 10 (cst) is set in function extended edition 4 and earlier versions.</li> <li>- Under full-closed control, the control mode was set to Two-degree-of-freedom control mode (synchronization type). (Note) The first edition of the software version (Ver1.01) does not support this.</li> </ul>	<ul style="list-style-type: none"> <li>- Check the preset value of 6060h (Modes of operation).</li> <li>- Check the parameters Pr6.47 bit0 and bit3 related to two-degree-of-freedom control mode.</li> </ul> <p>Note: The parameter shipment values are different from MINAS-A5B series.</p>
	2	ESM requirements during operation error protection	<ul style="list-style-type: none"> <li>- When PDS state was "Operation enabled" or "Quick stop active", received the ESM state change command to other ESM states.</li> <li>- When Pr7.99 bit0=1 is set, the command for transiting from the current ESM to other ESM state was received during servo-on (while warning D2 is occurring) on PANATERM.</li> </ul>	Check the state transition request from host controller.
	3	Improper operation error protection	<ul style="list-style-type: none"> <li>- When EXT1/EXT2 is not assigned to input signal, EXT1/EXT2 was selected in trigger selection of a touch probe (60B8h (Touch probe function)).</li> <li>- When Z-phase is chosen by trigger selection of a touch probe (60B8h(Touch probe function)) at the time of absolute mode of full-closed.</li> <li>- When the software limit function is enabled, a wraparound occurred to the actual position or command position.</li> <li>- The calculation result of electronic gear ratio fell outside the range of 8000 times to 1/1000 times.</li> <li>- In the calculation process of electronic gear ratio, the denominator or numerator exceeds an unsigned 64-bit size.</li> <li>- In the final calculation result of electronic gear ratio, the denominator or numerator exceeds an unsigned 32-bit size.</li> </ul>	<ul style="list-style-type: none"> <li>- Set up the functional allotment for input signal correctly.</li> <li>- Set up trigger selection correctly.</li> <li>- Check the relation between the operation range setting and the software limit setting.</li> <li>- Review the electronic gear settings and turn ON the power again.</li> </ul>

(To be continued)

Error No.		Protective function	Causes	Measures
Main	Sub			
91	1	Command error protection	<ul style="list-style-type: none"> <li>- When the Communication cycle setting is 0.25ms or 0.125ms, the external scale position information monitor function under semi-closed control is enabled.</li> <li>- Under full-closed control and in the DC synchronization mode or SM2 synchronization mode, the communication cycles were set to 0.250 ms and 0.125 ms. (Note) The first edition of the software version (Ver1.01) does not support this.</li> <li>- In the continuous rotating absolute encoder mode, a position outside the movable range (exceeding the Position range limit (607Bh)) was set as the target position. (Note) The first edition of the software version (Ver1.01) does not support this.</li> </ul>	<ul style="list-style-type: none"> <li>- When the external scale position information monitor function under semi-closed control is enabled, or under full-closed control, set the communication cycle to 0.500 ms or longer.</li> <li>- When using absolute positioning under pp control or csp control in the continuous rotating absolute encoder mode, set the target position to a position inside the movable range (within the Position range limit (607Bh)).</li> </ul>
	3	Command error protection 2	<ul style="list-style-type: none"> <li>• During semi-closed control and when the external scale was AB phase output type, touch probe operation was started under the following conditions. <ul style="list-style-type: none"> <li>• The settings for bit0 and bit8 of 4304h are different.</li> <li>• Both bit0 and bit8 of 4304h are "1", and when bit2 of 60B8h is "0" and bit0 of 60B8h is set to "1", or, when bit10 of 60B8h is "0" and bit8 of 60B8h is set to "1".</li> </ul> </li> <li>• During semi-closed control, return to origin was started by setting either or both of bit0 and bit8 of 4304h to "1".</li> </ul>	<ul style="list-style-type: none"> <li>• Review the settings of 4304h and 60B8h and start the touch probe operation.</li> <li>• Review the setting of 4304h and start the return to origin operation.</li> </ul>
92	0	Encoder data recovery error protection	In the absolute mode with semi-closed control, internal position data has not been correctly initialized.	<ul style="list-style-type: none"> <li>• Regulate the power source of the encoder to 5 VDC <math>\pm 5\%</math> (4.75–5.25 V). Measure the voltage at the encoder cable end if it is long.</li> <li>• If the motor cable and encoder cable are bundled together, separated them.</li> <li>• Connect the shield to FG.</li> </ul>
	1	External scale data recovery error protection	In the absolute mode with full-closed control, internal position data has not been correctly initialized.	<ul style="list-style-type: none"> <li>• Regulate the power source of the external scale to 5 VDC <math>\pm 5\%</math> (4.75–5.25 V)...Measure the voltage at the external scale connection cable end if it is long.</li> <li>• If the motor cable and external scale connection cable are bundled together, separated them.</li> <li>• Connect the shield to FG...See the external scale connection diagram. in Standard specifications.</li> </ul>
	3	Multi-turn data upper-limit value disagreement error protection	At continuous rotating absolute encoder function, there was a disagreement between the upper-limit value of encoder multi-turn data and the upper-limit value of driver parameter multi-turn data.	Check the parameter setting value.
93	2	Parameter setup error protection 2	External scale ratio exceeds acceptable range.	<ul style="list-style-type: none"> <li>• Check the parameter setting value.</li> <li>• External scale ratio must be in the range 1/40 to 125200 times.</li> </ul>
	3	External scale connection error protection	<ul style="list-style-type: none"> <li>• The communication type of the connected external scale (serial communication model) does not match the type selected by Pr 3.23 External scale selection.</li> <li>• Pr3.23 "External scale type selection"=3, 4 or 5 was set when Pr0.01 "Control mode selection"=6 was set. (Note) It is not supported in versions corresponding to function extended edition 2 or earlier.</li> </ul>	<ul style="list-style-type: none"> <li>• Set Pr 3.23 to the type of external scale connected.</li> <li>• Check the setting in Pr3.23 "External scale type selection" again.</li> </ul>
	5	Parameter setup error protection 4	A value exceeding 0 was set in Pr6.102 "Setting of over-travel inhibition release level" when Pr5.04 "Over-travel inhibition input setting" was set to a value other than 1.	Check the parameter setting values.
	8	Parameter setup error protection 6	<ul style="list-style-type: none"> <li>• The continuous rotating absolute encoder function was set to enable with other than the 23-bit resolution absolute encoder.</li> <li>• Absolute home position offset is set outside the range in continuous rotating absolute mode</li> <li>• The actual position became out of range in infinite rotation absolute mode and single-turn absolute mode.</li> </ul>	Check the parameter setting value.

(To be continued)

Error No.		Protective function	Causes	Measures
Main	Sub			
94	3	Home position return error protection 2	<ul style="list-style-type: none"> <li>When Pr7.22 bit7 = 1 and Pr5.04 = 0 or 1 (Pr5.04 is ignored under pp mode), POT or NOT has become ON while return operation to detected Z phase position at homing with Z phase.</li> <li>The return amount to the detected Z phase position became abnormal in Home position return which used Z phase.</li> <li>In the homing operation in the absolute mode, there was a trouble in the EEPROM writing of Pr7.120 "Absolute Scale Offset 1" or Pr7.121 "Absolute Scale Offset 2". (Note) It is not supported by the software versions of function extended version 3 or earlier.</li> </ul>	<ul style="list-style-type: none"> <li>Expand the distance between Z phase and POT or NOT.</li> <li>After confirming the safety, it's made bit7 of Pr7.22 (Communication function extended setup 1) =0(Invalid).</li> <li>Clear the alarm and start homing operation again. If this alarm is displayed and the error still occurs, there is a possibility that the machine is out of order. Stop using the machine and change the servo amplifier.</li> <li>Return the machine to the dealer for investigation (repair).</li> </ul>
95	0-4	Motor automatic recognition error protection	The motor and the driver have not been matched.	Replace the motor which matches to the driver.
96	2	Control unit error protection 1	An error occurred in the servo driver control unit.	<ul style="list-style-type: none"> <li>Turn the power off and then on again.</li> <li>Return the products to the dealer or manufacturer.</li> </ul>
	3	Control unit error protection 2		
	4	Control unit error protection 3		
	5	Control unit error protection 4		
	6	Control unit error protection 5		
	7	Control unit error protection 6		
	8	Control unit error protection 7		
98	2	Communication hardware error protection 2	Fault is determined in EtherCAT communication related peripheral device.	<ul style="list-style-type: none"> <li>Turn off the power once, then re-enter.</li> <li>If error repeats, this might be a failure. Stop using the products, and replace the motor and the driver.</li> <li>Return the products to the dealer or manufacturer.</li> </ul>
	3	Communication hardware error protection 3		
	5	Hardware self-diagnosis abnormality protection 1	The current detector has an abnormality.	Return to a dealer for investigation (repair).
Other No.	Other error	Other error protection	Control circuit has malfunctioned due to excess noise or other causes. Some error has occurred inside of the driver while triggering self-diagnosis function of the driver.	<ul style="list-style-type: none"> <li>Turn off the power once, then re-enter.</li> <li>If error repeats, this might be a failure. Stop using the products, and replace the motor and the driver.</li> <li>Return the products to the dealer or manufacturer.</li> </ul>

## Overload protection time characteristics

[Small type MSMF]

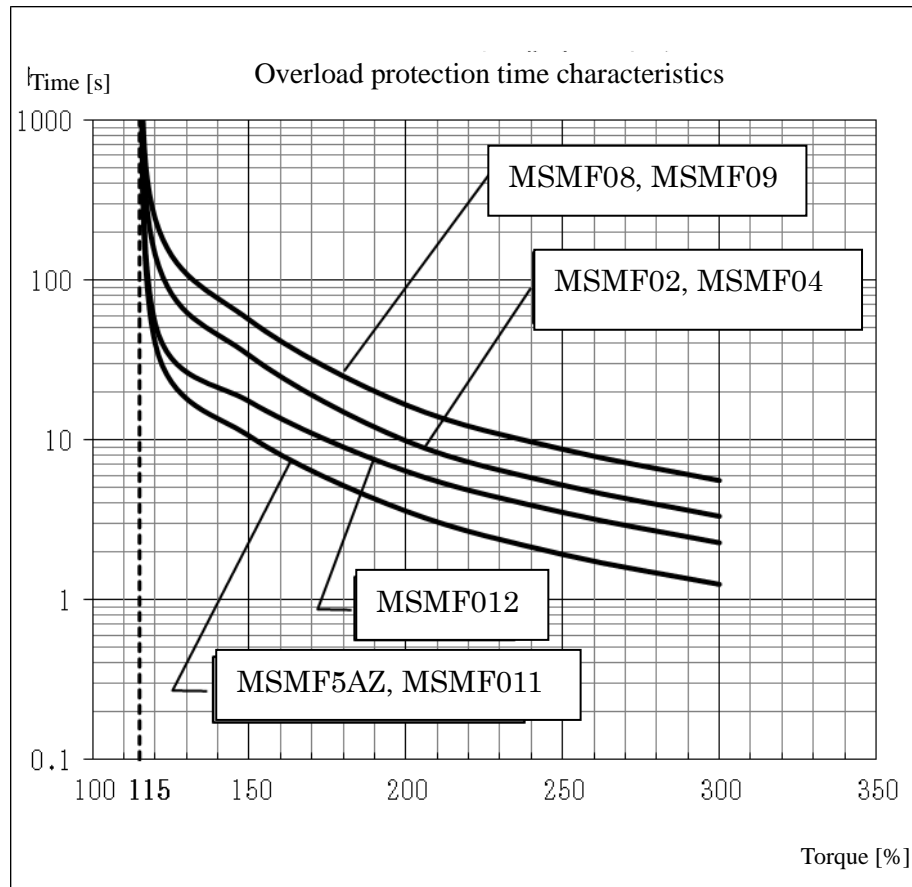

NOTE) Use the motor so that actual torque stays in the continuous running range shown in S-T characteristic of each motor.

Check the motor specification for "S-T characteristic."

[Small type MHMF]

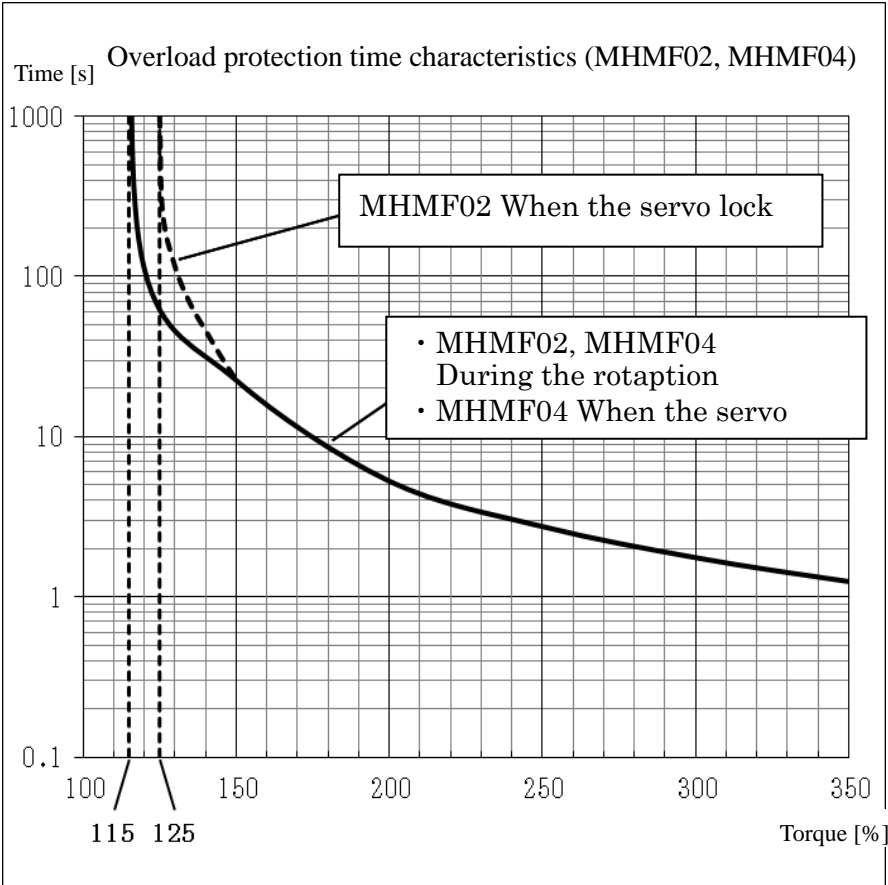
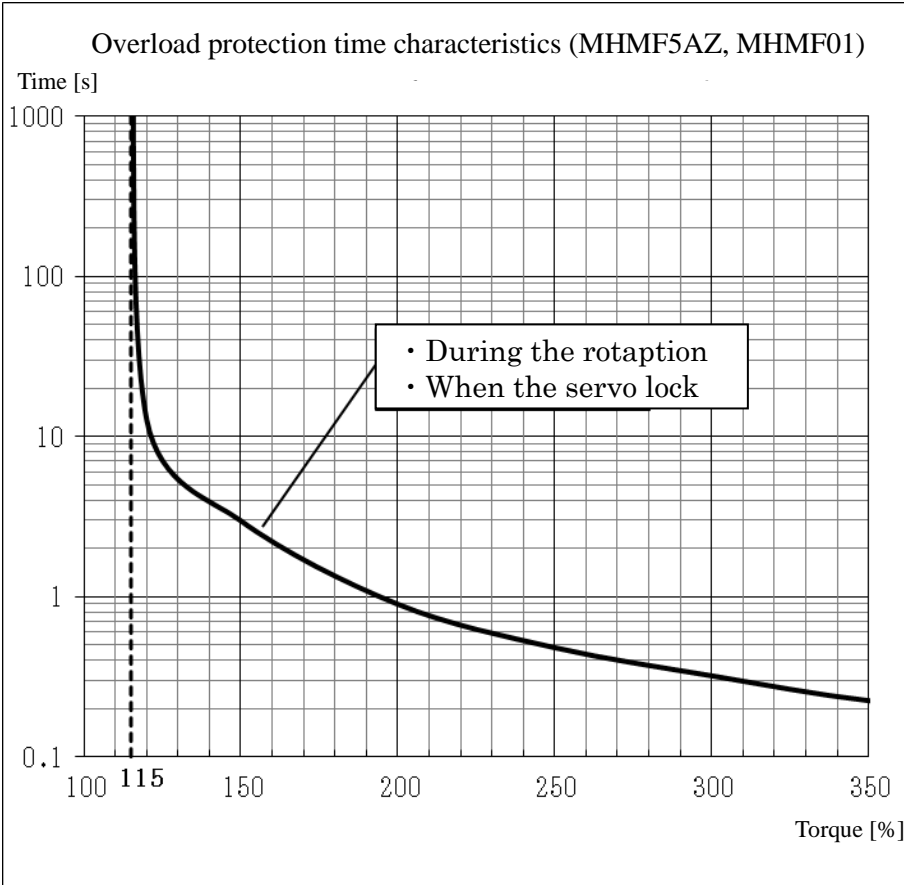

NOTE) Use the motor so that actual torque stays in the continuous running range shown in S-T characteristic of each motor.  
Check the motor specification for "S-T characteristic."



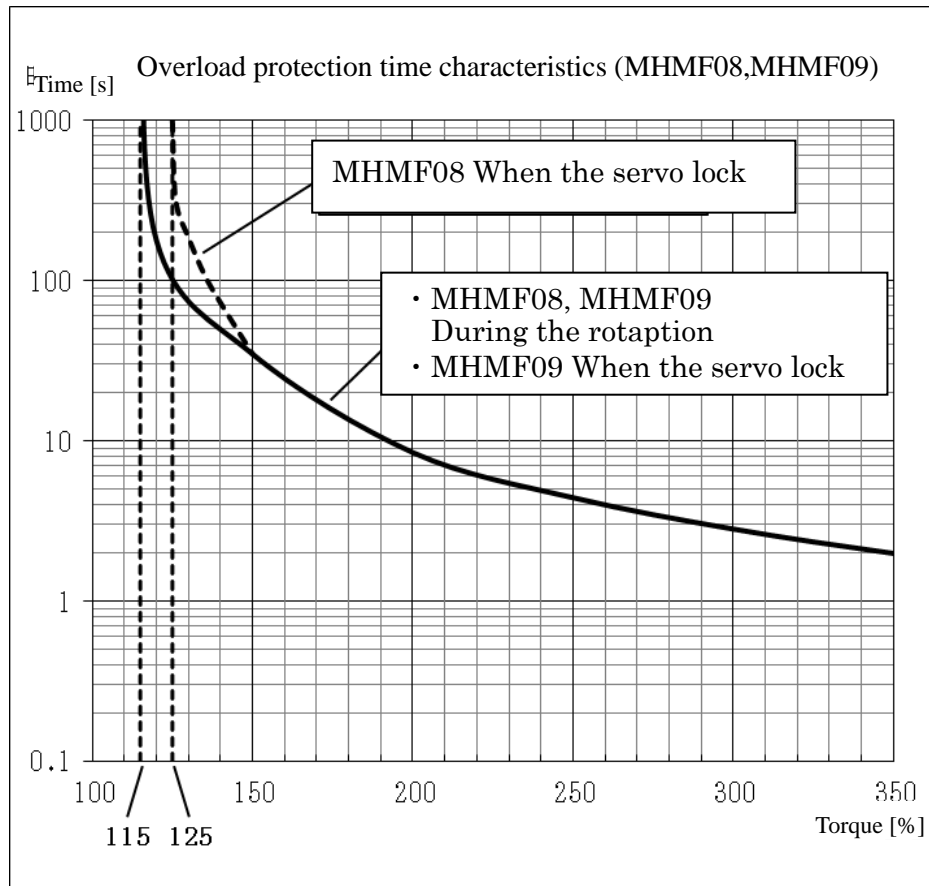

NOTE) Use the motor so that actual torque stays in the continuous running range shown in S-T characteristic of each motor.  
Check the motor specification for "S-T characteristic."

[Small type MQMF]

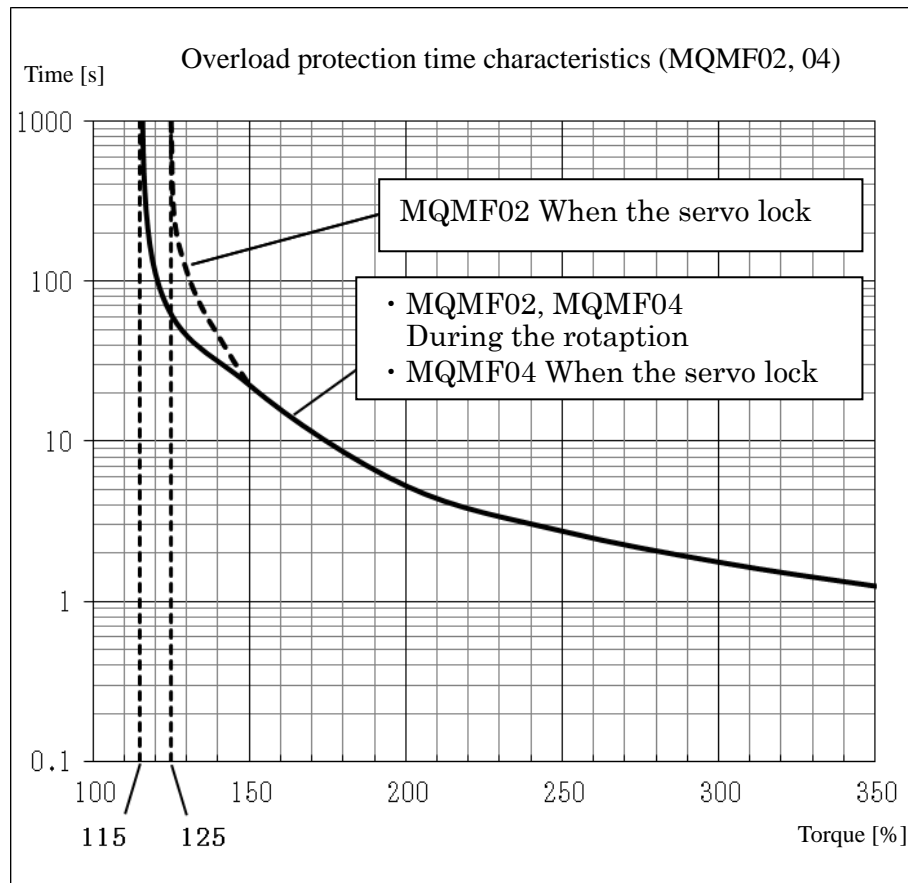
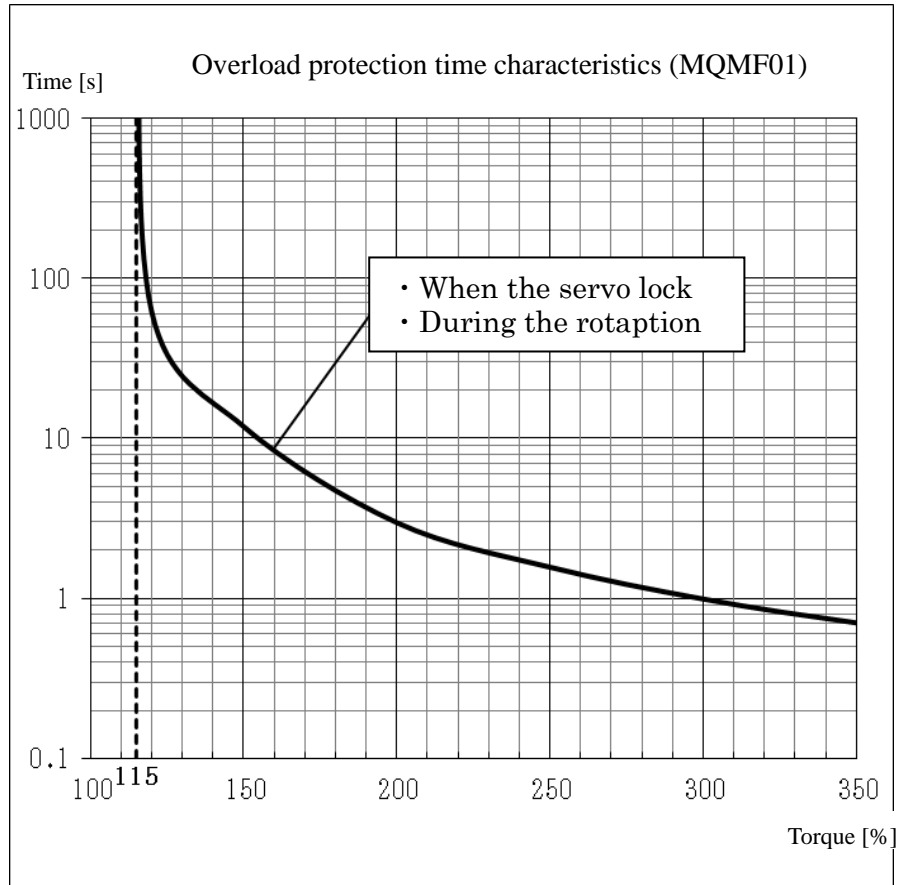

NOTE) Use the motor so that actual torque stays in the continuous running range shown in S-T characteristic of each motor.  
Check the motor specification for "S-T characteristic."

[Large type MDMF]

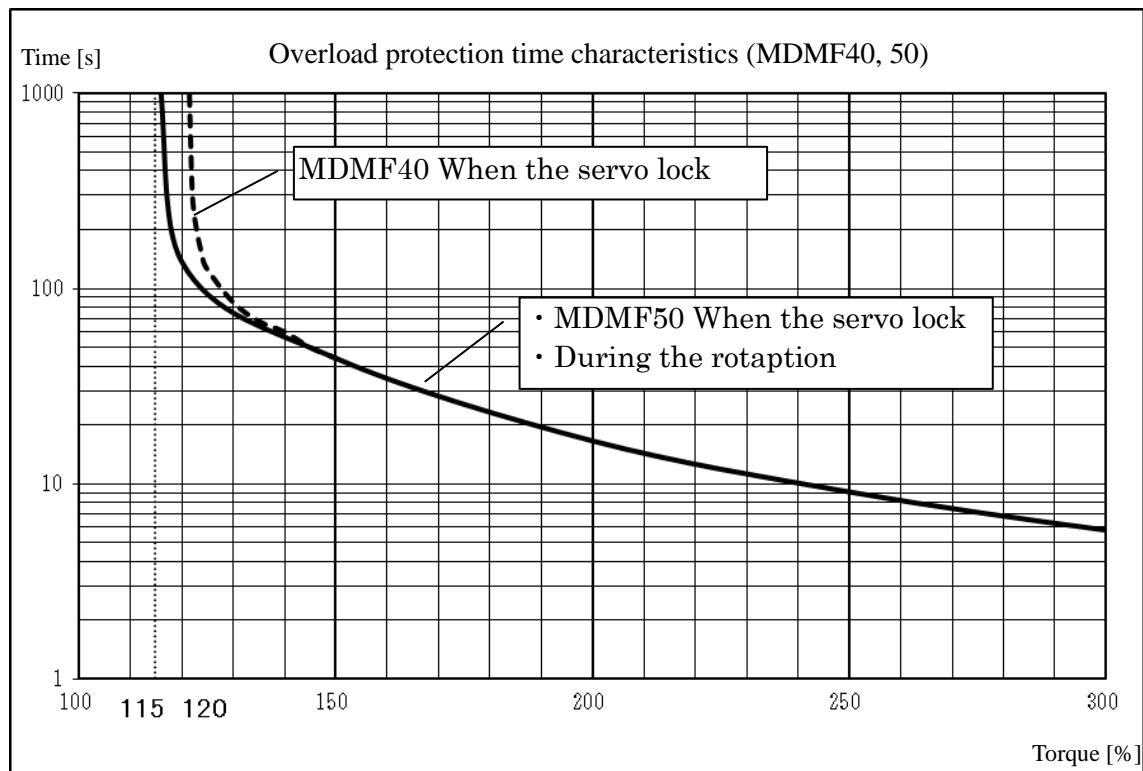
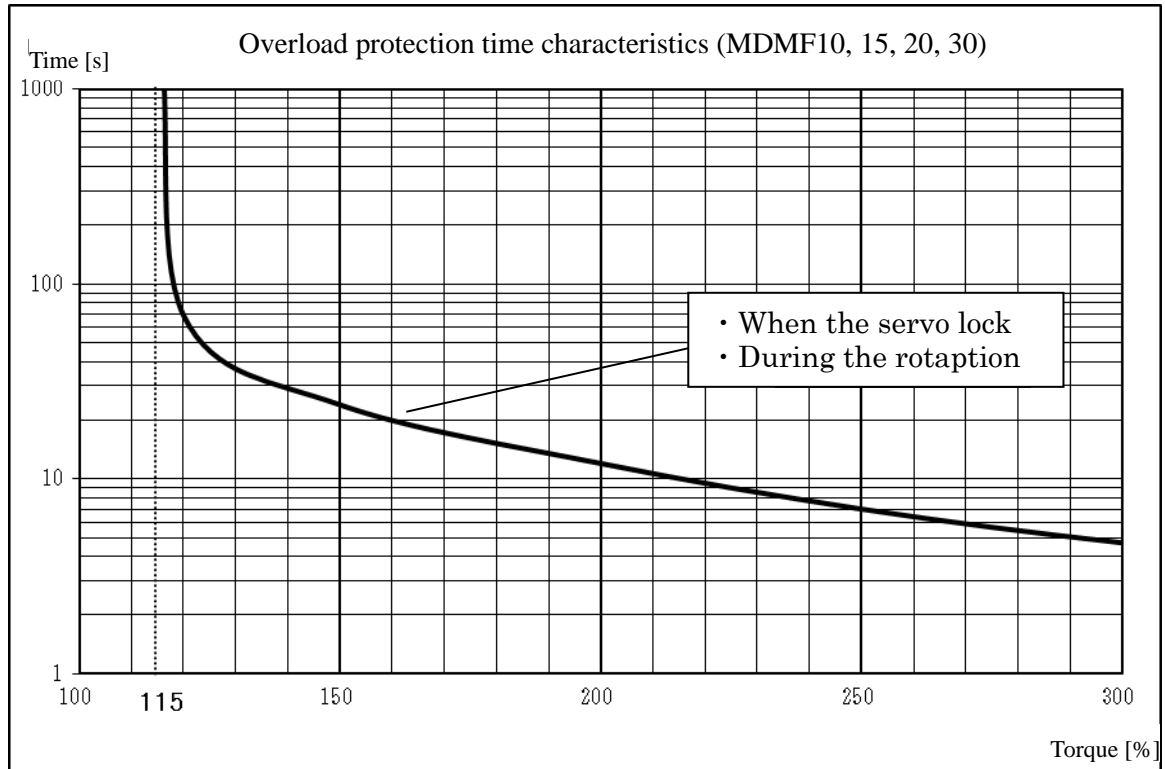

NOTE) Use the motor so that actual torque stays in the continuous running range shown in S-T characteristic of each motor.  
Check the motor specification for "S-T characteristic."

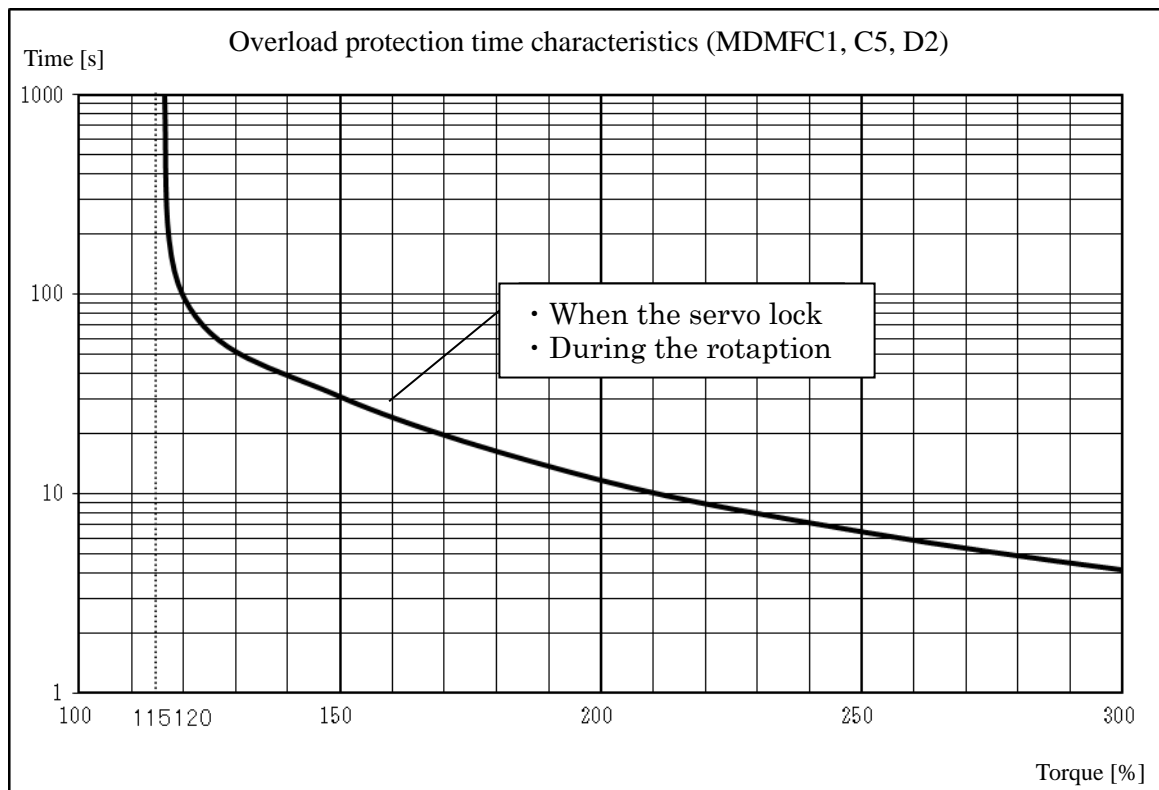
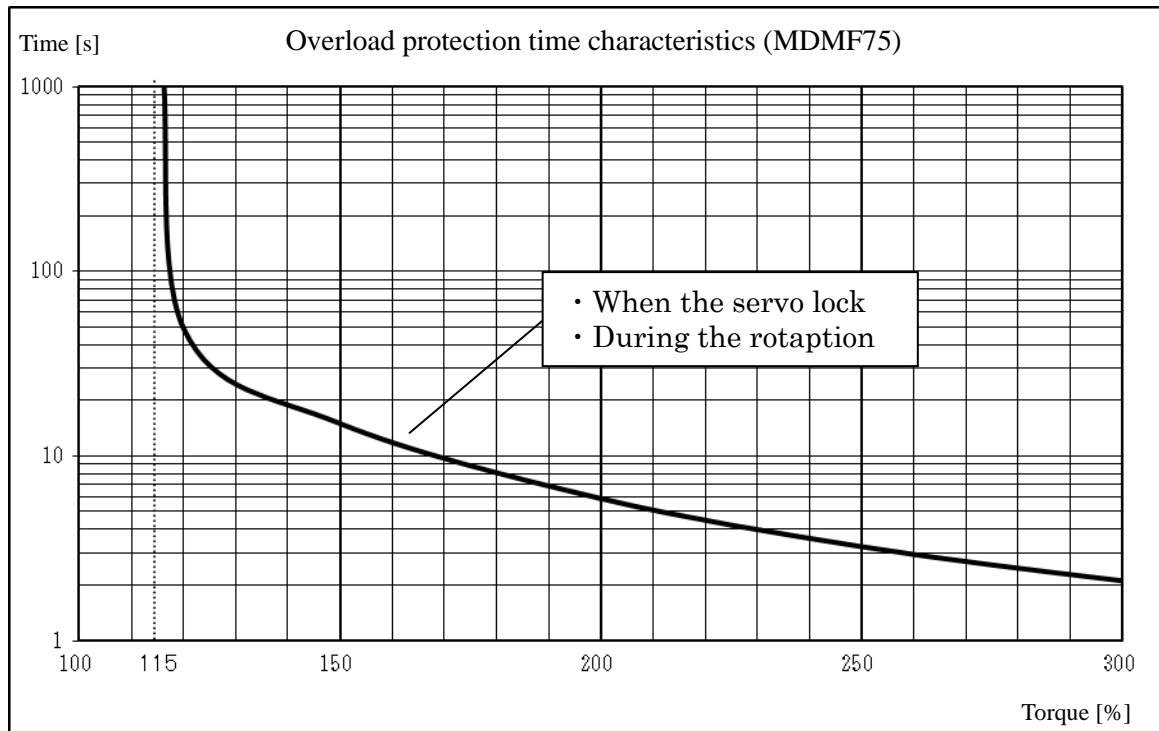

NOTE) Use the motor so that actual torque stays in the continuous running range shown in S-T characteristic of each motor.  
Check the motor specification for "S-T characteristic."

[Large type MGMF]

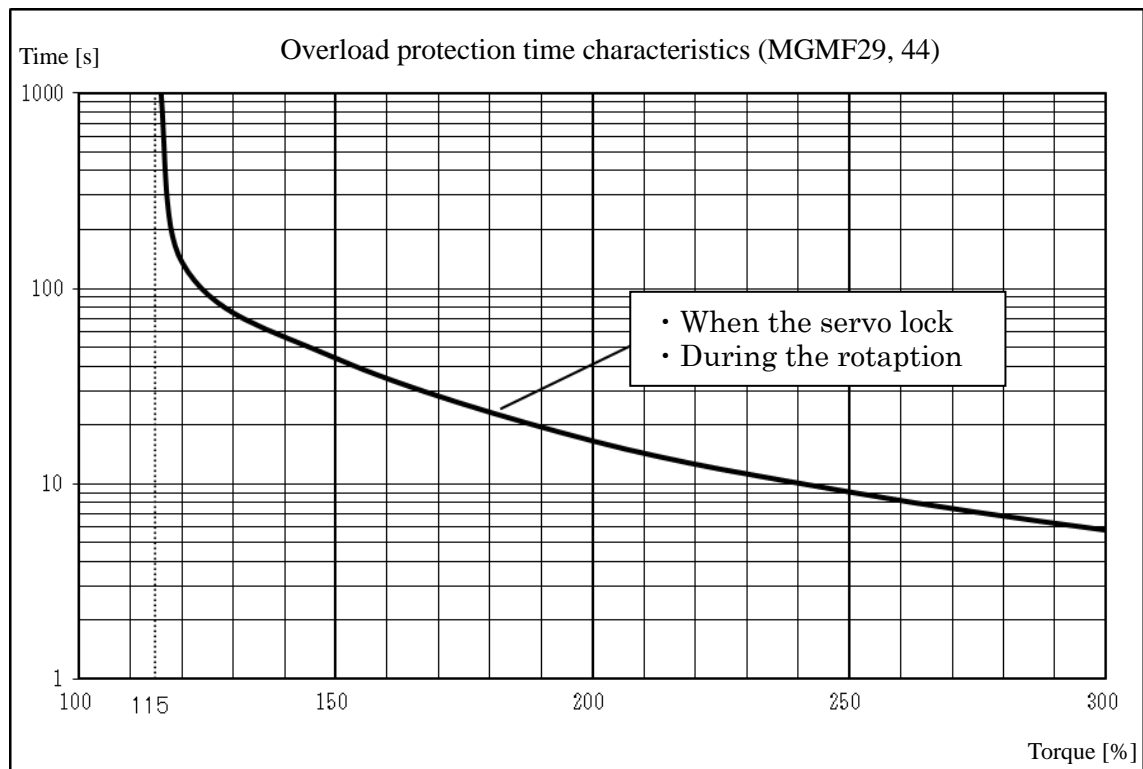
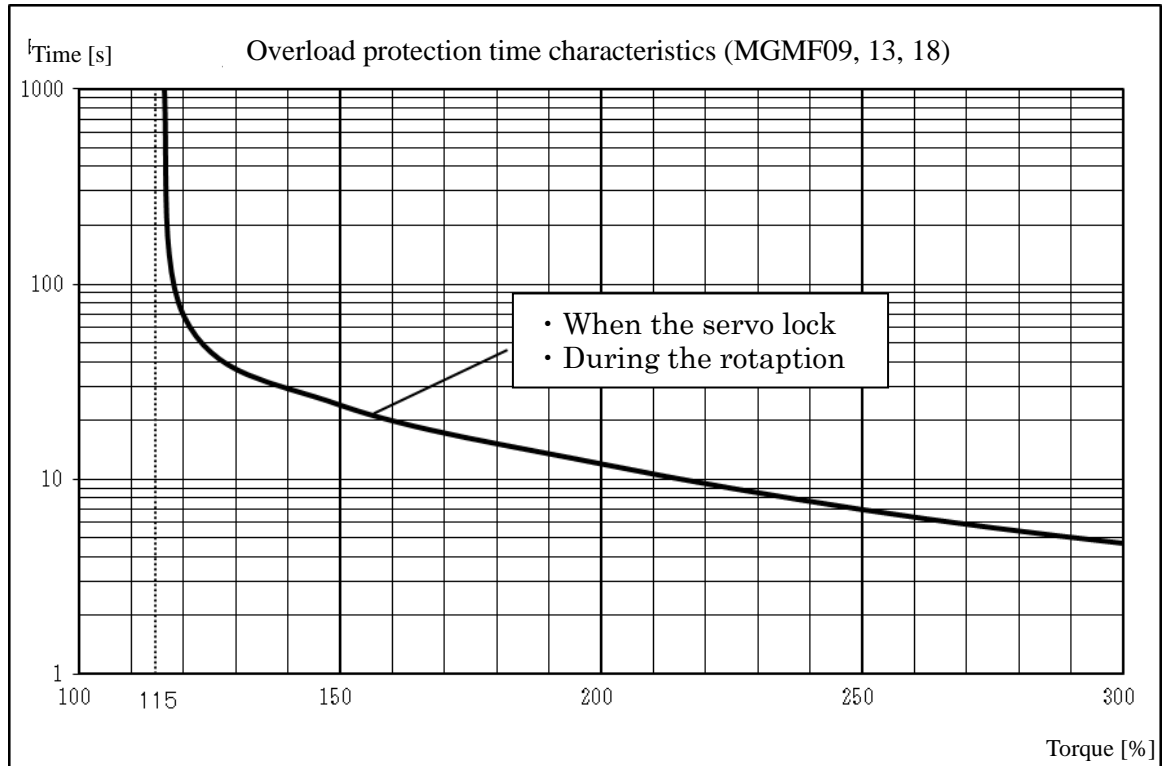

NOTE) Use the motor so that actual torque stays in the continuous running range shown in S-T characteristic of each motor.

Check the motor specification for "S-T characteristic."

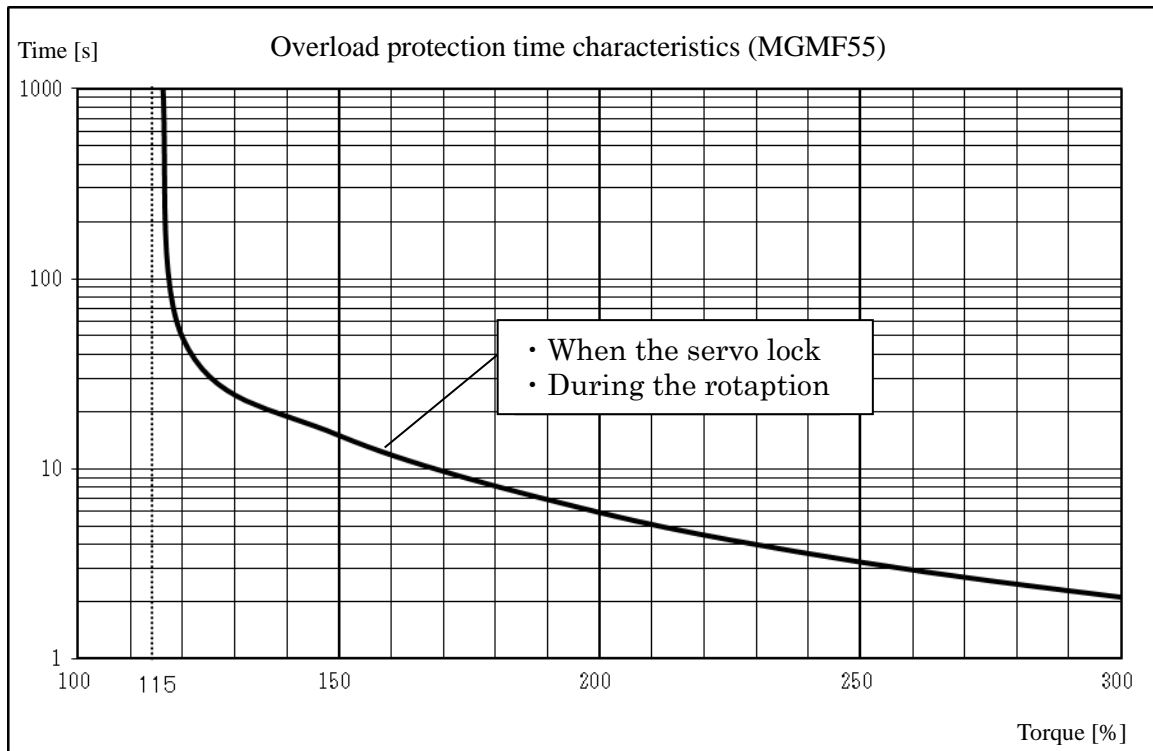

NOTE) Use the motor so that actual torque stays in the continuous running range shown in S-T characteristic of each motor.  
Check the motor specification for "S-T characteristic."

[Large type MHMF]

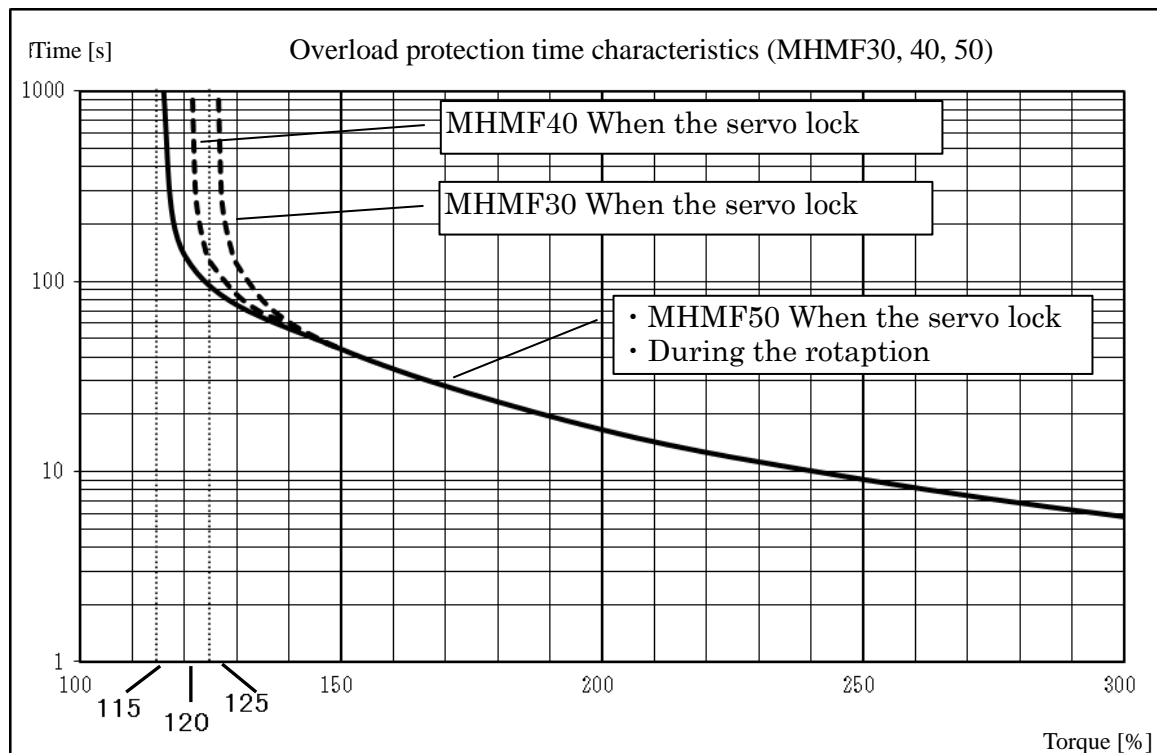
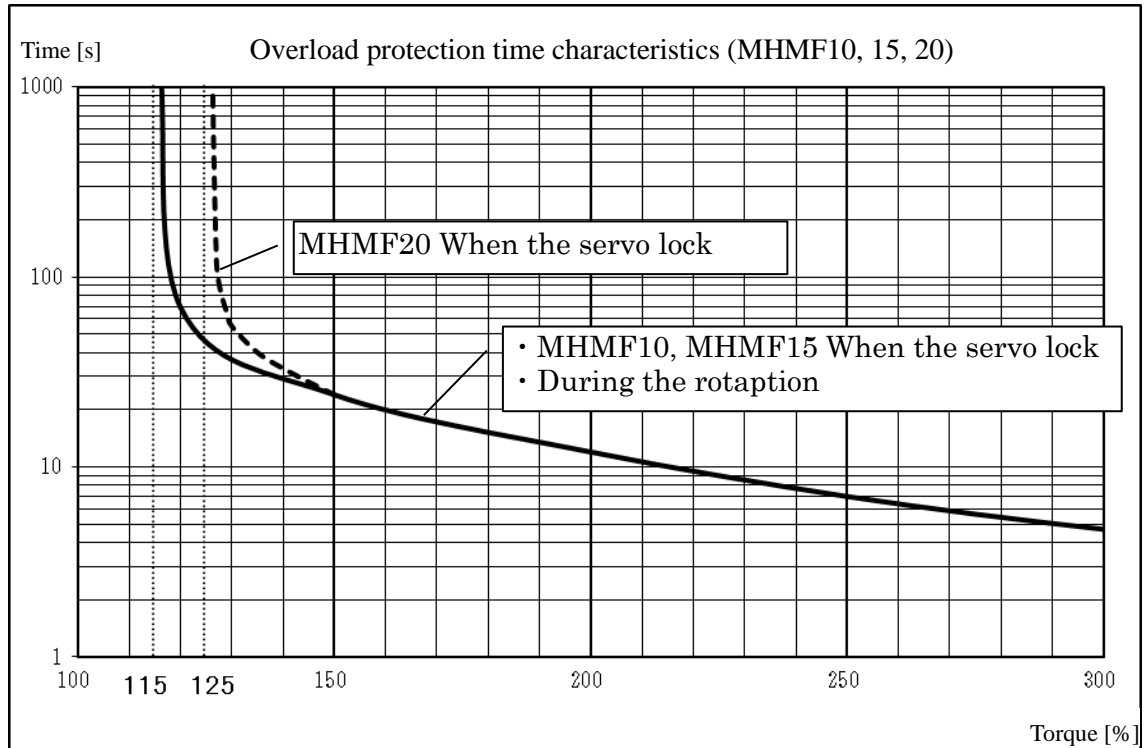

NOTE) Use the motor so that actual torque stays in the continuous running range shown in S-T characteristic of each motor.

Check the motor specification for "S-T characteristic."

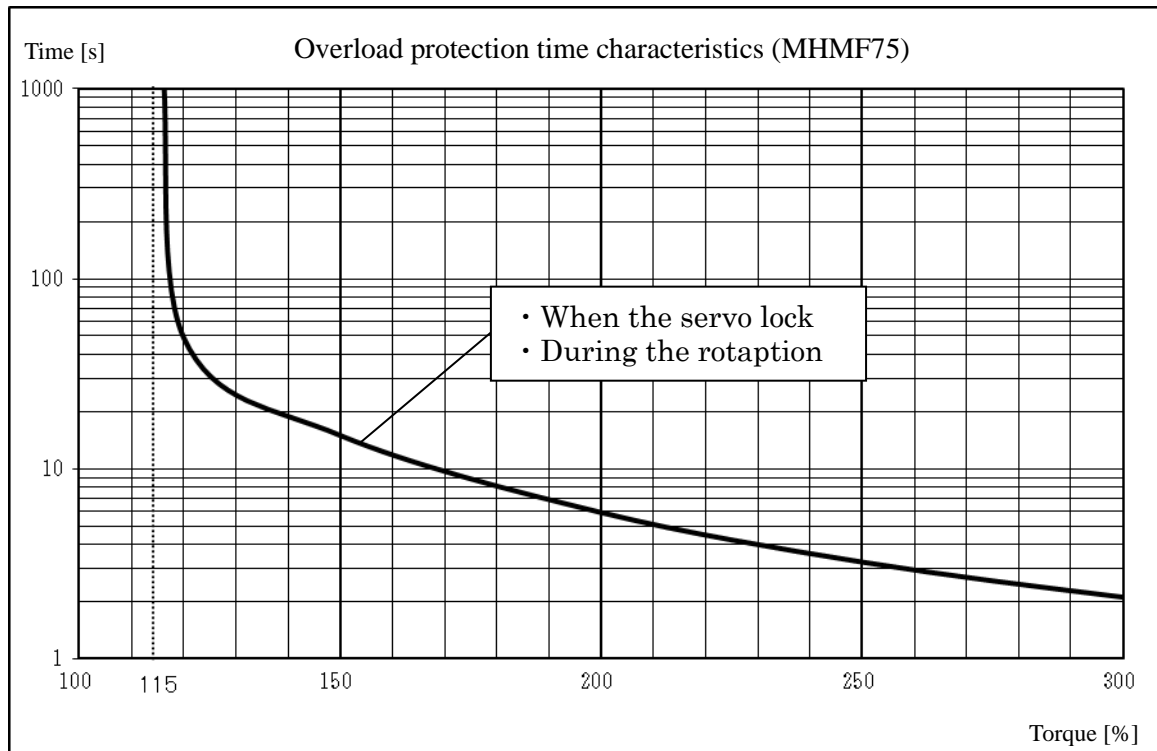

NOTE) Use the motor so that actual torque stays in the continuous running range shown in S-T characteristic of each motor.  
Check the motor specification for "S-T characteristic."



[Large type MSMF]

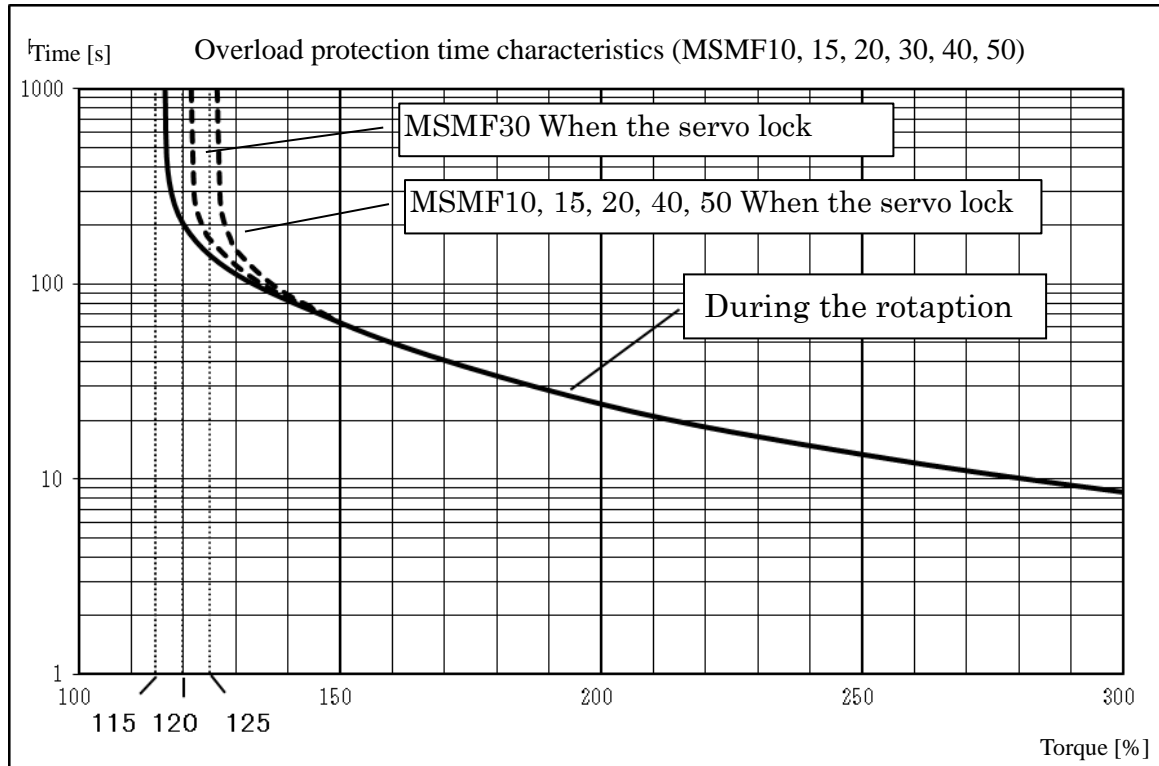

[Small type MSMD]

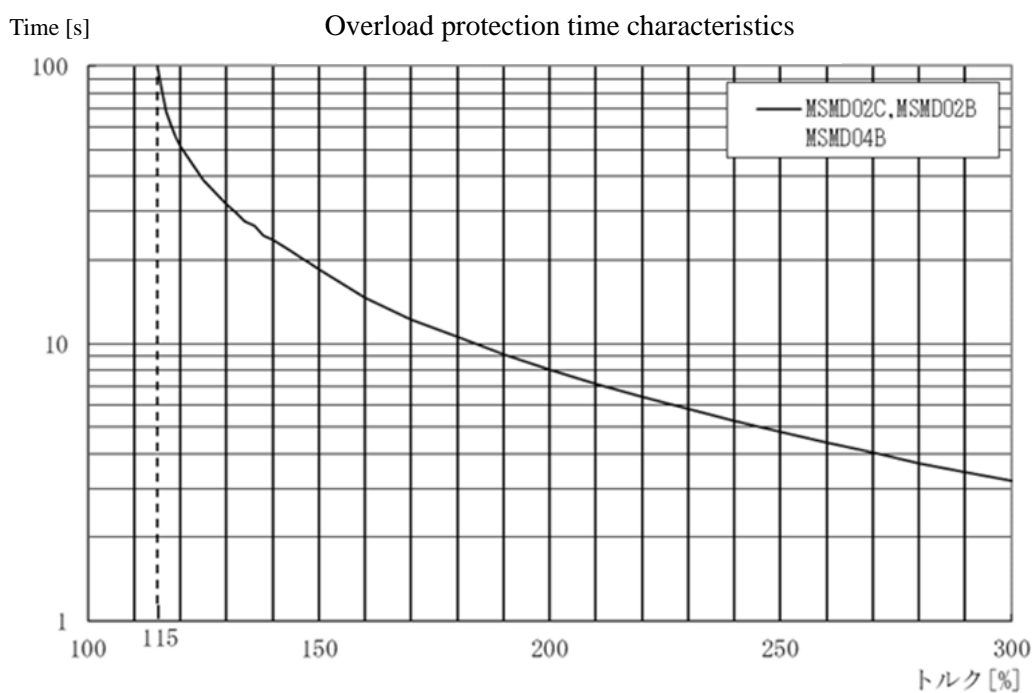

NOTE) Use the motor so that actual torque stays in the continuous running range shown in S-T characteristic of each motor.  
Check the motor specification for "S-T characteristic."

## 7-3 Warning function

The warning will be triggered before the protective function is activated, and you can check the conditions such as overload beforehand.

One of the following warning modes can be selected through the setting of Pr 6.27 Warning latch state setting: the warning non-latch mode in which the warning is automatically cleared 1 sec. after the cause of warning is removed, and the warning latch mode in which the warning is kept issued even after the cause of warning is removed. To clear the latched state, use the alarm clearing procedure described in previous alarm section.

Note that the battery warning is latched by the encoder: after unlatching at the encoder, the warning is cleared.

## (1) Relevant parameters

Class	No.	Attribute *1)	Title	Range	Unit	Function
4	40	A	Selection of alarm output 1	0-40	—	Select the type of warning issued as the warning output 1 (WARN1). Setup value 0: ORed output of all warnings. For 1 and subsequent see the table below.
4	41	A	Selection of alarm output 2	0-40	—	Select the type of warning issued as the warning output 2.(WARN2) Setup value 0: ORed output of all warnings. For 1 and subsequent see the table below.
6	27	C	Warning latch state setup	0-3	—	Set the latching state of warning. General warning and extended warning can be specified. bit 0: Extended warning      0: unlatch, 1: latch bit 1: General warning      0: unlatch, 1: latch
6	37	B	Oscillation detecting level	0-1000	0.1%	Set the threshold of oscillation detection. When torque vibration beyond this setting is detected, an oscillation detection alarm is activated. If the set value is 0, this function is disabled and the alarm is not activated.
6	38	R	Alarm mask setup	-32768 -32767	—	Set the warning detection mask. To disable detection of a warning, place 1 to the corresponding bit.
6	39	C	Alarm mask setup 2	-32768 -32767	—	
6	95 *2)	A	Over-load warning detection level	0-114	%	Sets the threshold value for detecting the warning as the overload load factor increases. Sets with the overload load factor. If 0 is set, overload warning detection is performed under conventional conditions (85% of overload protection level). In addition, if other than "Pr6.96 ≤ Pr6.95 < (Overload protection level)" is set, overload warning detection is performed under conventional conditions (85% of overload protection level).
6	96 *2)	A	Over-load warning release level	0-114	%	Sets the threshold value for releasing the warning when the load factor decreases from the state when the overload warning is occurring. Sets with the overload load factor. If 0 is set, overload warning detection is performed under conventional conditions (85% of overload protection level). In addition, if other than "Pr6.96 ≤ Pr6.95 < (Overload protection level)" is set, overload warning detection is performed under conventional conditions (85% of overload protection level).
6	97	B	Function expansion setup 3	-2147483648 -2147483647	—	bit 1:Deterioration diagnosis warning function: 0: Invalid, 1: valid bit14: Over-travel inhibition warning 0: Invalid, 1: valid
7	14	C	Main power off warning detection time	0-2000	1 ms	Specifies a time to wait until a main power off warning is detected when main power shut-off continues. 0-9, 2000: Warning detection is disabled. 10-1999: Unit is [ms]

\*1) For parameter attribute, refer to Section 9-1.

\*2) The numbers of parameters for overload warning detection or release level are different from MINAS-A5BL series.

## (2) Warning types

## ■ General warning

Warning No. (Hex.)	Warning	Content	Warning latch	Output setting	Warning mask																										
			Pr 6.27 *1)	Pr 4.40/ Pr 4.41 *2)	Pr 6.38/ Pr 6.39 Corresponding bit *3)																										
A0	Overload warning *7)	The specification for warning detection varies depending on the values of Pr6.95 (Over-load warning detection level) and Pr6.96 (Over-load warning release level), and it becomes as shown in the table below.	○ *7)	1	Pr 6.38 bit 7																										
		<table border="1"> <thead> <tr> <th>Pr6.95</th> <th>Pr6.96</th> <th>Pr6.95 Pr6.96 Relationship between magnitude</th> <th>warning detection specification</th> <th>warning release specification</th> <th>Remarks</th> </tr> </thead> <tbody> <tr> <td rowspan="2">Other than 0</td> <td>Other than 0</td> <td>Pr6.95&gt;= Pr6.96</td> <td>Load factor is Pr6.95 or more</td> <td>Load factor less than Pr6.96</td> <td>Extended specification</td> </tr> <tr> <td>0</td> <td>Pr6.95&lt; Pr6.96</td> <td rowspan="2">Load factor is 85% or more of the protection level</td> <td rowspan="2">Load factor is less than 85% of the protection level</td> <td rowspan="2">Please do not set</td> </tr> <tr> <td rowspan="2">0</td> <td>Other than 0</td> <td>-</td> <td rowspan="2">Conventional specification</td> </tr> <tr> <td>0</td> <td>0</td> <td></td> <td></td> <td></td> </tr> </tbody> </table>				Pr6.95	Pr6.96	Pr6.95 Pr6.96 Relationship between magnitude	warning detection specification	warning release specification	Remarks	Other than 0	Other than 0	Pr6.95>= Pr6.96	Load factor is Pr6.95 or more	Load factor less than Pr6.96	Extended specification	0	Pr6.95< Pr6.96	Load factor is 85% or more of the protection level	Load factor is less than 85% of the protection level	Please do not set	0	Other than 0	-	Conventional specification	0	0			
		Pr6.95				Pr6.96	Pr6.95 Pr6.96 Relationship between magnitude	warning detection specification	warning release specification	Remarks																					
		Other than 0				Other than 0	Pr6.95>= Pr6.96	Load factor is Pr6.95 or more	Load factor less than Pr6.96	Extended specification																					
0	Pr6.95< Pr6.96		Load factor is 85% or more of the protection level	Load factor is less than 85% of the protection level	Please do not set																										
0	Other than 0	-				Conventional specification																									
	0	0																													
A1	Over-regeneration warning	Regenerative load factor exceeded 85% of protection level.	○	2	Pr 6.38 bit 5																										
A2	Battery warning *4)	Battery voltage is 3.2 V or lower.	Latch fixed	3	Pr 6.38 bit 0																										
A3	Fan warning	Fan has stopped for 1 sec.	○	4	Pr 6.38 bit 6																										
A4	Encoder communication warning	The number of successive encoder communication errors exceeds the specified value.	○	5	Pr 6.38 bit 4																										
A5	Encoder overheat warning	The encoder temperature exceeds the specified value. *8)	○	6	Pr 6.38 bit 3																										
A6	Oscillation detection warning	Oscillation or vibration is detected.	○	7	Pr 6.38 bit 13																										
A7	Lifetime detection warning	Life expectancy of capacitor or fan becomes short.	Latch fixed	8	Pr 6.38 bit 2																										
A8	External scale error warning	The external scale detects the warning.	○	9	Pr6.38 bit 8																										
A9	External scale communication warning	The number of successive external scale communication errors exceeds the specified value.	○	10	Pr6.38 bit 10																										
AC	Deterioration diagnosis warning *6)	Load characteristic estimates or torque command under constant speed has exceeded the set range.	○	22	Pr6.39 bit7																										

■ Extended warning

Warning No. (Hex.)	Warning	Content	Warning latch	Output setting	Warning mask
			Pr 6.27 *1)	Pr 4.40/ Pr 4.41 *2)	Pr6.38/Pr6.39 Corresponding bit *3)
C3	Main power off warning	When setting of Pr7.14 (Main power off warning detection time) is 10-1999, instantaneous power interruption occurs between L1 and L3 and lasts for a time longer than the setting of Pr7.14.	○	14	Pr 6.38 bit 12
D2	PANATERM command execution warning	When bit0 of Pr7.99"Communication function Extended setup 6" is 1 and EtherCAT communication is established, the operation command (such as test run and FFT) by setup support software (PANATERM) is executed.	○	30	Pr6.39 bit8
D3	Over-travel inhibition warning *9)	Entered the over-travel inhibition state.	○	31	Pr6.39 bit9

- \*1) The mark circle indicates that the warning status can be maintained or cleared by the setting of Pr 6.27 "Warning latch state setup". Battery warning and lifetime detection warning will be in the lath mode only.
- \*2) Select the warning output signal 1 (WARN 1) or warning output signal 2 (WARN 2) through Pr 4.40 "Warning output select 1" or Pr 4.41 "Warning output select 2". When the set value is 0, all warnings are ORed before being output. Do not set to any value other than those specified in the table above.
- \*3) A warning detection can be disabled through Pr 6.38 "Warning mask setup" or Pr 6.39 "Warning mask setup 2", by setting the bit shown above to 1.  
Also note that bit arrangements of these masks are different from MINAS-A6S series (ex. MINAS-A6SE).
- \*4) In the case of Pr0.15 = 1 (incremental mode), Pr0.15 = 3 (single-turn absolute mode) when using the battery-powered absolute encoder, or when using the battery-less absolute encoder, no battery warning is detected.
- \*5) The warning can be cleared by the alarm clearing operation.  
If the cause of the warning is not yet removed, the warning will be detected again after clearing.  
When an external alarm clear (A-CLR) is in the ON state, the warning does not occur.
- \*6) Invalidated when Pr6.97 "Function expansion setup 3" bit1 = 0.
- \*7) Settings of Pr6.95 and Pr6.96 allow you to enable the expansion specification of overload warning detection.  
See the next page.
- \*8) Take measures such as lowering the ambient temperature and reducing the load, or re-examining the heat dissipation.
- \*9) It is disabled when Pr6.97 "Function expansion setting 3" bit14 is set to 0.  
It occurs only when 1 is specified for Pr5.04 "Over-travel inhibition input setting".

- Expansion specification enabled under “Pr6.95 and Pr6.96 are other than 0” and “Pr6.96  $\leq$  Pr6.95” and “Pr6.95 < Pr5.12”

In this specification, the warning latch function is invalid.

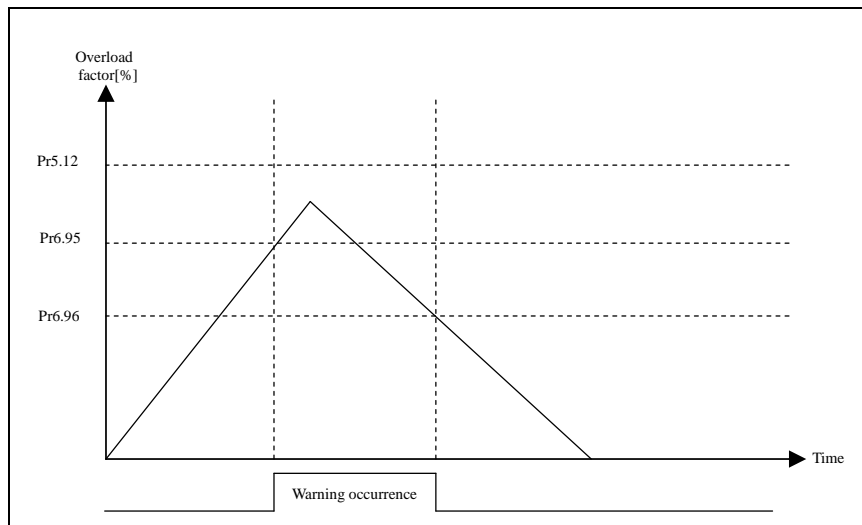

- Conventional specification enabled under conditions other than the above one.

In this specification, the warning latch function depends on the Pr6.27 setting.

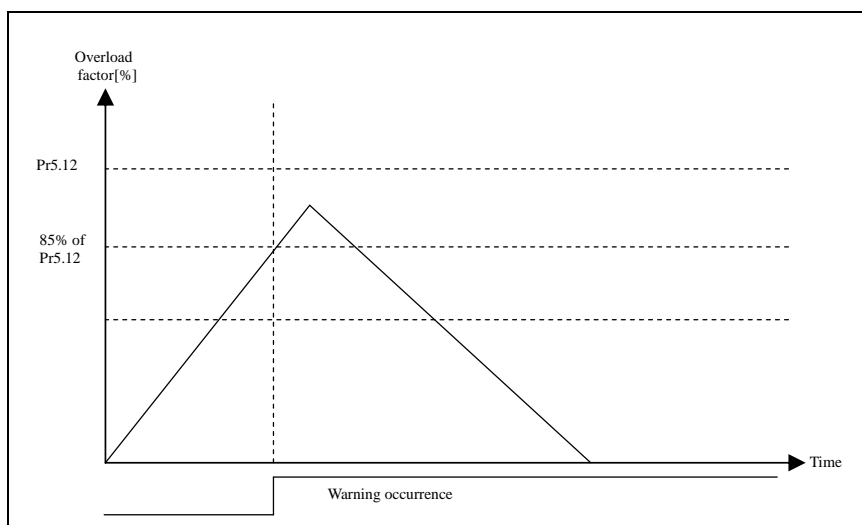

If switch to the extended specification by changing the set value of Pr 6.95 or Pr 6.96 during the overload warning with the warning latch function enabled, the overload warning may be cleared because the warning latch function become invalid.

(Note)

The numbers of parameters for overload detecting or releasing warning level are different from MINAS-A5BL series.

#### 7-4 Setup of gain pre-adjustment protection

Before starting gain adjustment, set the following parameters based on the conditions of use, to assure safe operation.

##### 1) Setup of over-travel inhibit input

By inputting the limit sensor signal to the driver, the bumping against mechanical end can be prevented. Refer to interface specification, positive/negative direction overtravel inhibit input (POT/NOT). Set the following parameters which are related to overtravel inhibit input.

Pr 5.04 Setup of over-travel inhibit input

Pr 5.05 Sequence at over-travel inhibit

##### 2) Setup of torque limit

By limiting motor maximum torque, damage caused by failure or disturbance such as bite of the machine and collision will be minimized. To uniformly limit maximum torque by using the parameter Pr 0.13 1st torque limit, first set Pr 5.21 Selection of torque limit to 0 or 1.

If the torque limit setup is lower than the value required during the actual application, the following two protective features will be triggered: over-speed protection when overshoot occurs, and excess positional deviation protection when response to the command delays.

By allocating the torque in-limit output (TLC) of interface specification to the output signal, torque limit condition can be detected externally.

##### 3) Setup of over-speed protection

Generates Err 26.0 Over-speed protection when the motor speed is excessively high.

Default setting is the applicable motor over-speed level.

If your application operates below the motor maximum speed, set Pr 5.13 Setup of over-speed level by using the formula below.

Pr 5.13 Setup of over-speed level =  $V_{max} \times (1.2 \text{ to } 1.5)$

$V_{max}$ : motor maximum speed [r/min] in operating condition

Factor in ( ) is margin to prevent frequent activation of over-speed protection.

When running the motor at a low speed during initial adjustment stage, setup the overspeed protection by multiplying the adjusting speed by a certain margin to protect the motor against possible oscillation.

## 4) Setup of the excess positional deviation protection

During the position control or full-closed control, this function detects potential excessive difference between the positional command and motor position and issues Err 24.0“Excess positional deviation protection”.

Excess positional deviation level can be set to Pr 0.14 “Position deviation excess setup”. The deviation can be detected through command positional deviation [pulse (command unit)] and encoder positional deviation [pulse (encoder unit)], and one of which can be selected by Pr 5.20 “Position setup unit select”. (See the control block diagram.)

Because the positional deviation during normal operation depends on the operating speed and gain setting, fill the equation below based on your operating condition and input the resulting value to Pr 0.14.

- When Pr 5.20 = 0 (detection through command positional deviation)

Pr 0.14 (Setup of positional deviation excess) =  $V_c / K_p \times (1.2 \text{ to } 2.0)$   
 $V_c$ : maximum frequency of positional command pulse [pulse (command unit)/s]  
 $K_p$ : position loop gain [1/s]  
 Factor in ( ) is margin to prevent frequent activation of excess positional deviation protection

- When Pr 5.20 = 1 (detection through encoder positional deviation and full-closed position deviational)

Pr 0.14 (Setup of positional deviation excess) =  $V_e / K_p \times (1.2 \text{ to } 2.0)$   
 $V_e$ : maximum operation frequency [pulse/s] in encoder unit or external scale unit  
 $K_p$ : position loop gain [1/s]  
 Factor in ( ) is margin to prevent frequent activation of excess positional deviation protection

Notes:

- When switching position loop gain  $K_p$ , select the smallest value for calculation.
- When switching from the velocity control to position control, position deviation correcting function is used, which will increase calculation value and error. To cope with these problems, increase the margin.

## 5) Setup of motor working range

During the position control or full-closed control(Not supported), this function detects the motor position which exceeds the revolutions set to Pr 5.14 Motor working range setup, and issues Err 34.0 Software limit protection.

For details, refer to 6-2 Motor working range setup function.

## 6) Hybrid deviation excess error protection setup

At the initial operation with full-closed control, operation failure may occur due to reverse connection of external scale or wrong external scale division ratio.

To indicate this type of defect, Err25.0 “Hybrid deviation excess error protection” is issued when the deviation of motor position (encoder unit) and load position (external scale unit) exceed Pr3.28 “Hybrid deviation excess setup.”

For details, refer to 4-5-3 Motor working range setup function.

## 7-5 About the protection function setting for homing return by using the Z phase

If the following parameters are set, the driver can detect inputting of over-travel inhibition (POT, NOT) during homing return to the Z phase detection position, which is treated as the origin with the operation for homing return by the Z phase.

If inputting of over-travel inhibition is detected during the return operation,

Err94.3 (returning to origin error protection 2) occurs, and the motor electricity is cut off, and it is stopped.

Pr7.22 bit7 (Communication function extended setup 1 (In Z phase homing Over-travel inhibit input setup)) = 1

(Note)

- If the above value is set to the parameter and the Z phase in the vicinity of inputting of over-travel inhibition (POT/NOT) is configured as the origin, Err94.3 may be erroneously detected because overshoot occurs while returning to the Z phase detection position treated as the origin.

In that case, please away the Z phase of the homing completion position from inputting of over-travel inhibition (POT/NOT), homing return near inputting of over-travel inhibition (POT/NOT) so as not to occur.

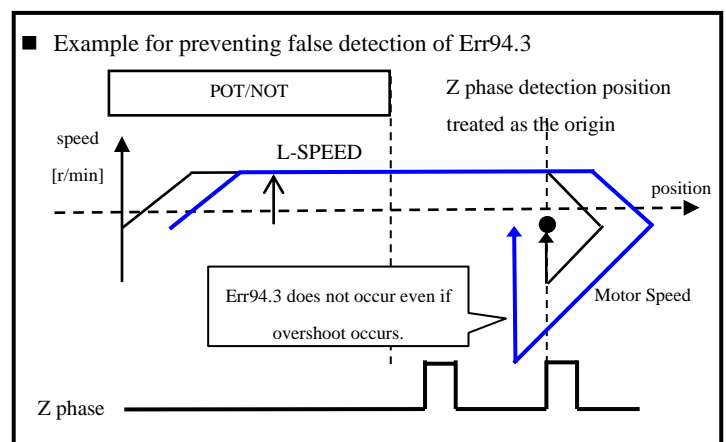
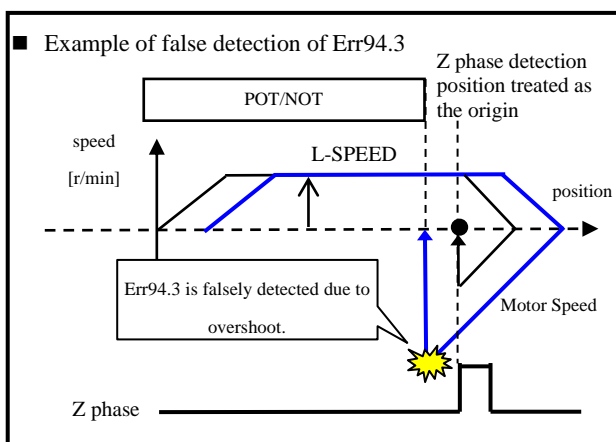

- If the above value is not set for the parameter, detection of inputting of over-travel inhibition (POT/NOT) during returning to the Z phase detection position, which is treated as the origin when returning to the origin by the Z phase, is disabled.



## (1) Relevant parameters

Class	No.	At-tribute *1)	Title	Range	Unit	Function
5	04	C	Over-travel inhibit input setup	0-2	—	<p>Set up the operation of the run-inhibition (POT, NOT) inputs. Normally it should be set to 1.</p> <p>0: Deceleration stop on servo (MINAS-A6) side (sequence upon inputting over-travel inhibition)  POT -&gt; inhibits positive direction drive,  NOT -&gt; inhibits negative direction drive.  When POT is input during positive direction driving, stops the drive according to Pr 5.05 Sequence at over-travel inhibit.  The similar function NOT is applied in reverse direction.</p> <p>1: CoE (CiA402) side deceleration stop  POT -&gt; inhibits positive direction drive,  NOT -&gt; inhibits negative direction drive.  When POT is input during positive direction driving, or NOT is input during negative direction driving, EtherCAT profile slowdown defined in CoE(CiA402) works and stops it.  The constants at the slowdown differ for every control mode.</p> <p>2: Deceleration stop on servo (MINAS-A6) side (sequence at alarm)  POT or NOT input activates Err 38.0 Run-inhibition input protection.</p>
7	22	R	Communication function extended setup 1	-32768-32767	—	bit7 : In Z phase homing Over-travel inhibit input setup 0 : Invalid 1 : valid

\*1) For parameter attribute, refer to Section 9-1.

## (2) protective function

Error No.		Protective function	Causes	Measures
Main	Main			
94	3	Home position return error2	<ul style="list-style-type: none"> <li>When Pr7.22 bit7 = 1 and Pr5.04 = 0 or 1 (Pr5.04 is ignored under pp mode), POT or NOT has become ON while return operation to detected Z phase position at homing with Z phase.</li> <li>The return amount to the detected Z phase position became abnormal in Home position return which used Z phase.</li> </ul>	<ul style="list-style-type: none"> <li>Expand the distance between Z phase and POT or NOT.</li> <li>After confirming the safety, it's made bit7 of Pr7.22 (Communication function extended setup 1) =0(Invalid).</li> </ul>

### 8. Safety function

This servo driver has safety function.

[A6BE] This function is not available.

« Change point from MINAS-A5B series »

	MINAS-A5B	MINAS-A6B	
STO operation	Alarm occur (Err30.0)	No alarm (7-segment LED is "St")	
Method of releasing the STO state	Release of the factors of STO and Alarm clear	After the STO state status When the alarm is not generated	After the STO state status When the alarm is generated
		Release of the factors of STO and PSD state is switch on disabled	Release of the factors of STO/alarm and Alarm clear

#### 8-1 Outline of safe torque off (STO) function

The safe torque off (STO) function is a safety function that shuts the motor current and turns off motor output torque by forcibly turning off the driving signal of the servo driver internal power transistor. For this purpose, the STO uses safety input signal and hardware (circuit).

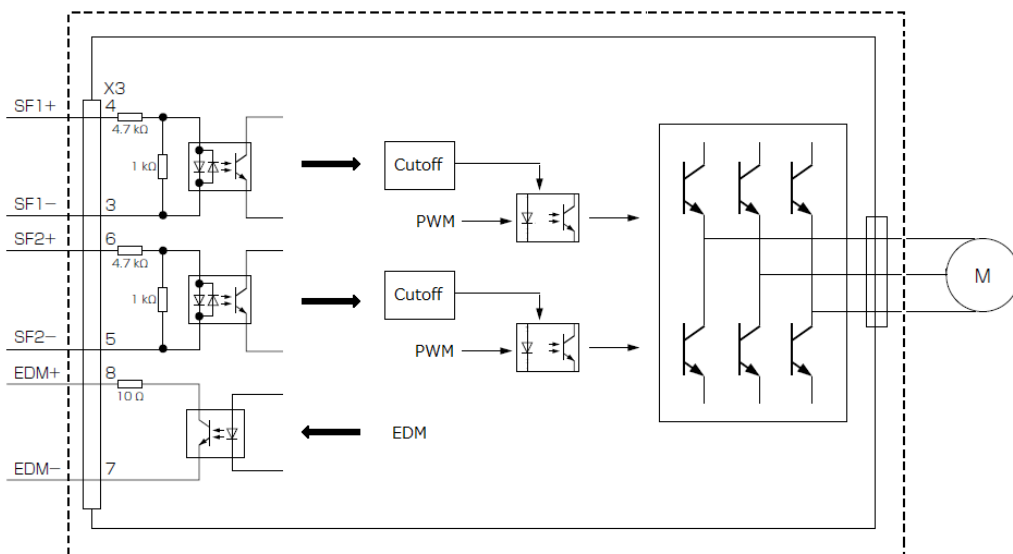

When STO is activated, the servo driver turns off the servo-ready output signal (S-RDY) and goes into a STO state, with the indication in the front panel turning to “St”. When STO input is released and servo-on input is Off, it will automatically transition itself to Servo ready state.

PSD state becomes switch on disabled, and ESM state will not shift

Note 1) Difference in operation compared to MINAS-A5B series:

Even if STO function is activated, it will not go into an alarm state, unlike the A5B series.

When safety function detects an error, it will trigger an alarm (Err31.0, Err31.2)

8-2 Input/output signal specification

8-2-1 Safety input signal

- Two safety input circuit channels that trigger STO function are provided.

Class	Signal name	Signal	Connector pin number	Content	Control mode			
					Position	Velocity	Torque	Full-closed
Input	Safety input 1	SF1 +	X3-4	<ul style="list-style-type: none"> <li>• It is input 1 that triggers STO function. This input turns off the upper arm drive signal of power transistor.</li> <li>• When using the function, connect this pin in a way so that the photocoupler of this input circuit turns off to activate STO function.</li> </ul>	○			
		SF1 -	X3-3					
	Safety input 2	SF2 +	X3-6	<ul style="list-style-type: none"> <li>• It is input 2 that triggers STO function. This input turns off the lower arm drive signal of power transistor.</li> <li>• When using the function, connect this pin in a way so that the photocoupler of this input circuit turns off to activate STO function.</li> </ul>				
		SF2 -	X3-5					

- Safety input 1 or 2 enables STO to operate within 5 ms after input, and then the motor output torque will be turned off.
- Input the same signal to Safety input 1 and 2.

NOTE) Safety equipment self-diagnosis L pulse

The safety output signal from the safety equipment such as safety controller and safety sensor may include L pulse for self-diagnosis. To prevent the L pulse from mis-triggering STO function, the safety input circuit has built-in filter that removes the self-diagnosis L pulse.

Therefore, if the off period of safety input signal less than 1 ms, the safety input circuit does not detect this off event.

To validate this off period, turn off the safety input signal for more than 5 ms.

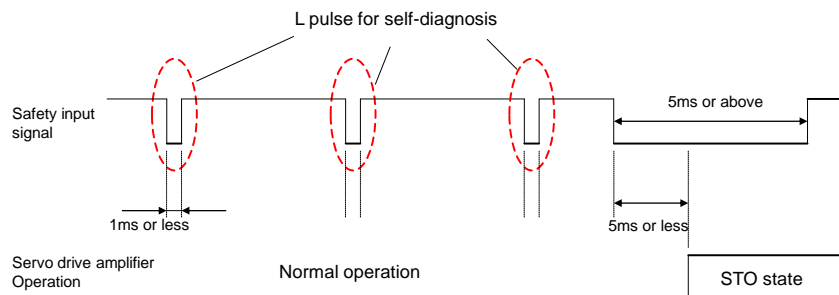

## 8-2-2 External device monitor (EDM) output signal

- The monitor output signal is used by the external device to monitor the state of the safety input signal.  
Be sure to connect the monitor output to the external device monitor terminal of the safety equipment such as safety controller and safety sensor.

Class	Signal name	Signal	Connector pin number	Content	Control mode			
					Position	Velocity	Torque	Full-closed
Output	EDM output	EDM +	X3-8	• Output monitor signal that is used to check the safety function.				○
		EDM-	X3-7					

- Logical relationship between safety input signal and EDM output signal is as follows.  
Under normal conditions, when both safety input 1 and 2 are off, i.e. when STO function of 2 safety input channels are active, the photocoupler in EDM output circuit turns on.

Signal name	Signal	Photocoupler logic			
Safety input	SF1	ON	ON	OFF	OFF
	SF2	ON	OFF	ON	OFF
EDM output	EDM	OFF	OFF	OFF	ON

By monitoring the logics (all 4 states) of photocoupler shown in the table above, the external device can determine the status (normal or abnormal) of safety input circuit and EDM output circuit. That is to say, in the case of an anomaly, although both safety input 1 and 2 are off, the photocoupler in EDM output circuit does not turn on.  
Or, although either safety input 1 or 2 or both safety input 1 and 2 turned on, the state in which the photocoupler in EDM output circuit turned on has been detected.

- Maximum delay time from input of safety 1 and 2 signals to output of EDM signal is 6 ms.
- In order to satisfy all the specification of functional safety, it is necessary to monitor the EDM signal with the host controller.
- Be sure to monitor the EDM signal at starting up the driver, every 3 months, and safety input.

## 8-3 Description of functions

## 8-3-1 Activation to STO state, timing diagram

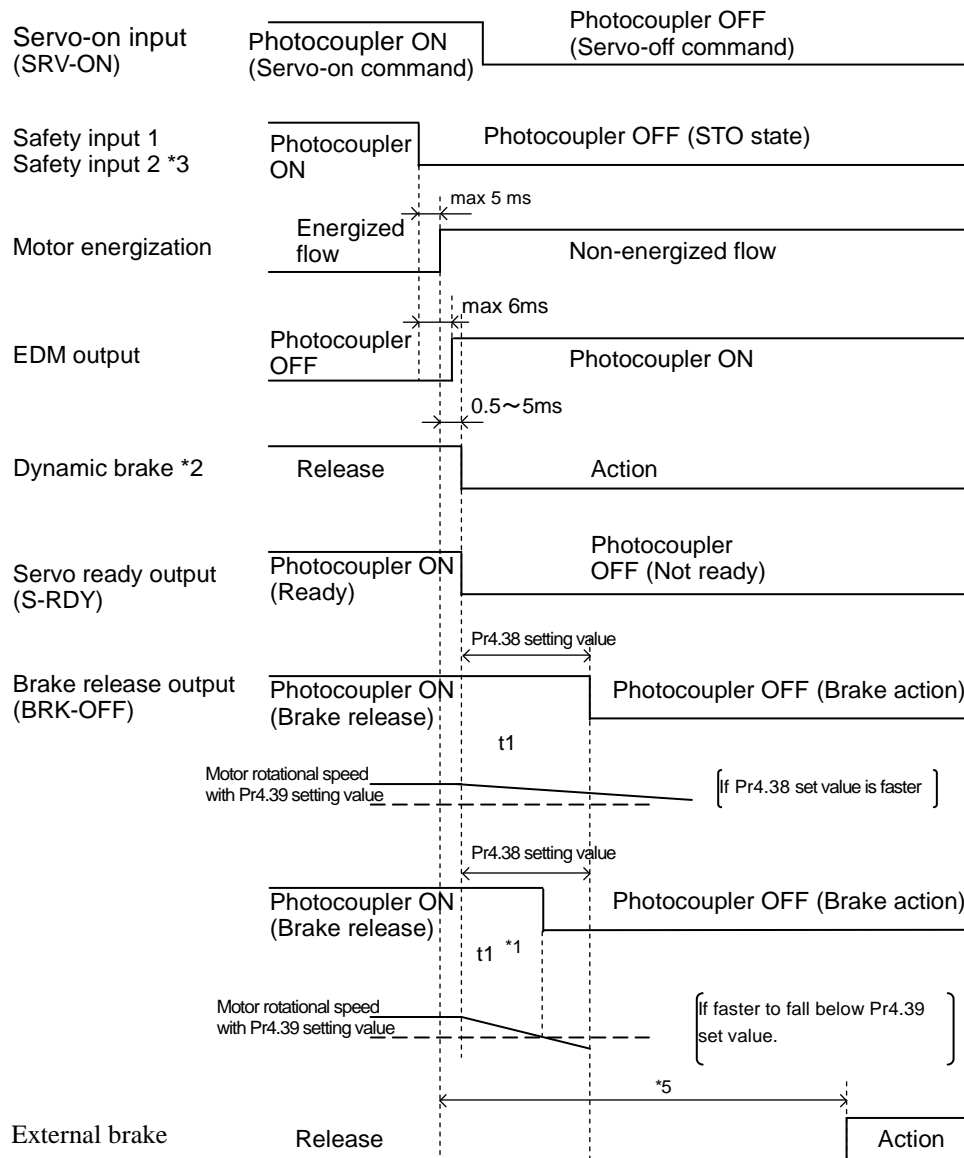

- \*1.  $t1$  will be a shorter time of either the setup value of Pr4.38 "Mechanical brake action at running setup" or elapsing time for the motor speed to fall below Pr4.39 "Brake release speed setup."
- \*2. Dynamic brake operates to the setting of Pr5.10 Sequence at alarm.  
(In STO state, even if an alarm does not occur, "Sequence at alarm" is applied.)
- \*3. To work STO function, please turn off safety input 1 and 2 at the same time.
- \*4. The driver will not enter an alarm state.
- \*5. Since servo-lock cannot be performed in the interval after motor energization is cut off until the external brake operates, the work may fall by gravity from the vertical axis. Take an appropriate measure to prevent this.

## 8-3-2 Return timing diagram from STO state

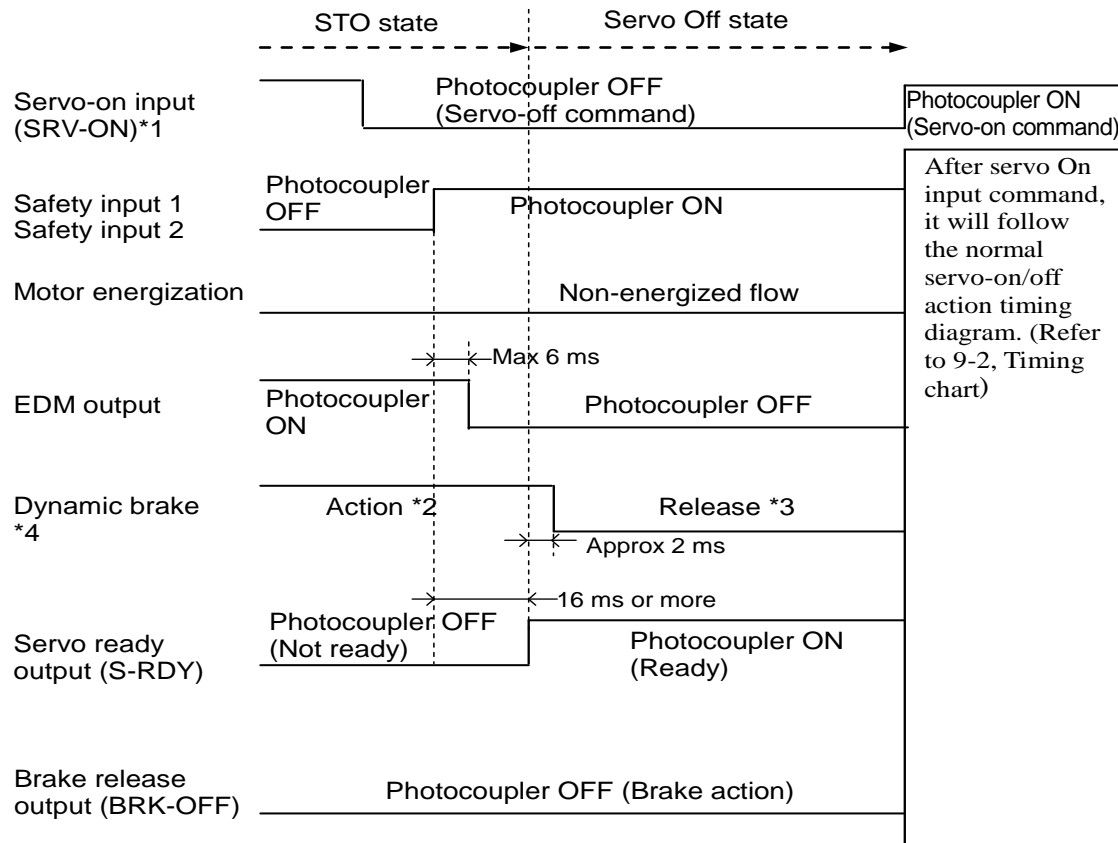

- \*1. Photocouplers for safety input 1 and 2 should be turned on again with servo-on input turned off. Returning photocouplers for safety inputs 1 and 2 to ON will automatically reset it to Servo ready mode. There is no need to conduct alarm-clear.
- \*2. This is an STO state and the dynamic brake operates according to Pr5.10 "Sequence at alarm." (In STO state, even if an alarm does not occur, "Sequence at alarm" is applied.)
- \*3. This is normal servo-off condition and the dynamic brake operates according to Pr5.06 "Sequence at servo-off."

## 8-4 Connection example

## « Attention point when connecting »

- Depending on the safety device to be connected, it is necessary to turn on the power supply of the driver first. At this time, the state of the driver becomes an alarm in MINAS-A5B series, becomes STO state in MINAS-A6B series.

The method of returning from the alarm state or STO state is as follows.

## « MINAS-A5B series »

- 0 Turn off servo ON command
- ① Return the photo couplers for safety input 1 and 2 to ON.
- ② Release the alarm.

## « MINAS-A6B series »

- ① Turn off servo ON command
- ② Return the photo couplers for safety input 1 and 2 to ON.

\* Automatically return to the servo ready state.

## 8-4-1 Example of connection to safety switch

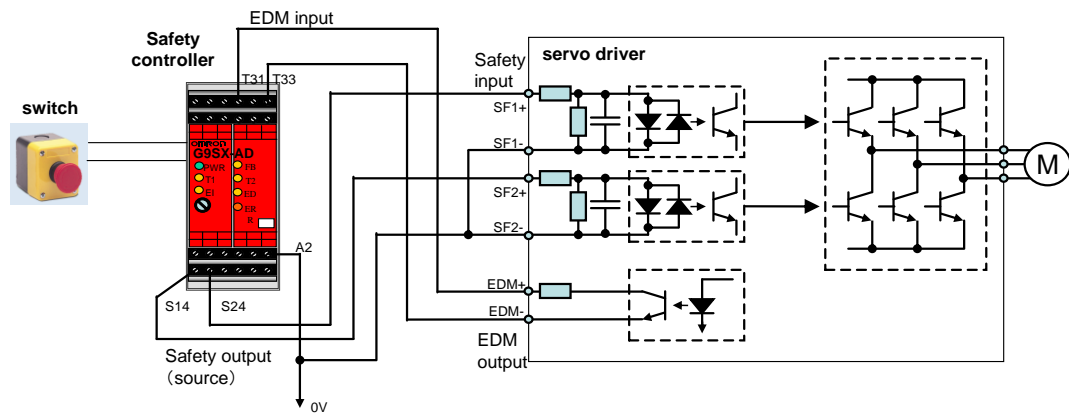

## 8-4-2 Example of connection when using multiple axes

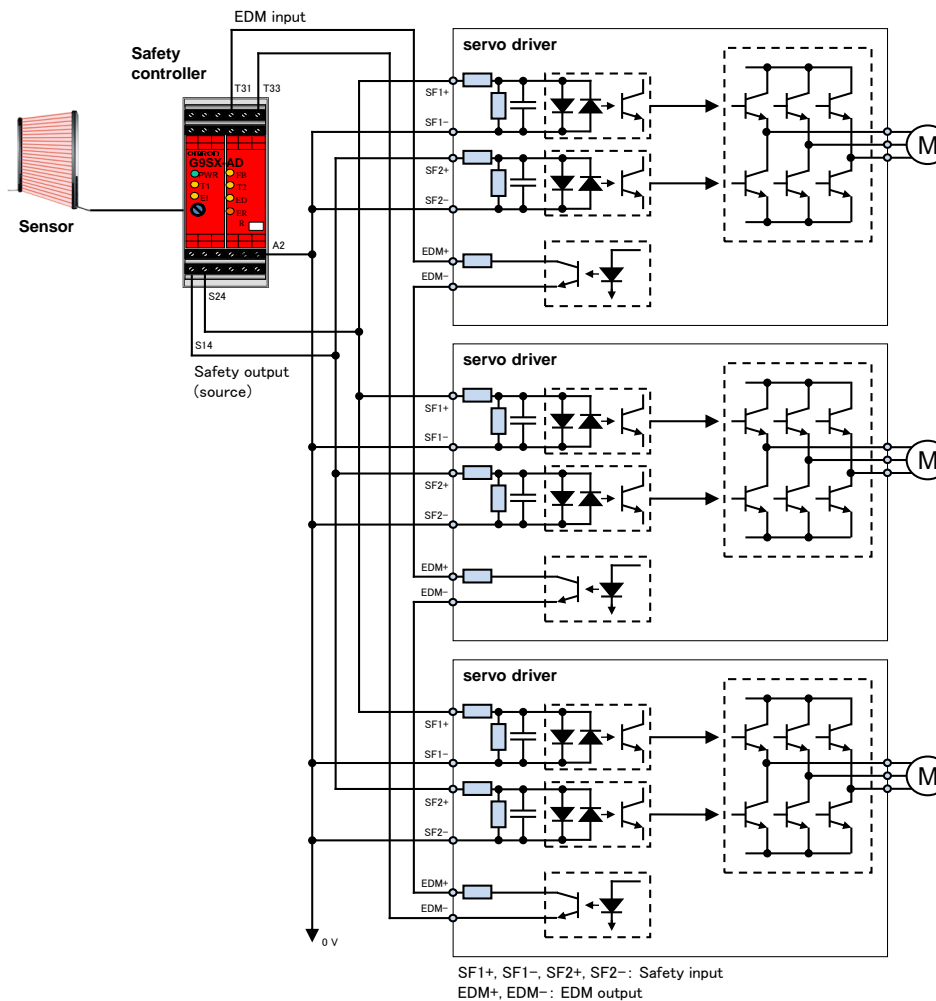

- Capacity requirement per safety output (source) channel:  $5 \times \text{No. of connected axes}$  (mA)
- DC 24 V supply allowable voltage:  $24 \text{ V} \pm 15 \%$
- Maximum No. of connectable axes: 8 axes \*1

\*1. The value is for reference.

When connecting EDM output in series, since the collector saturation voltage  $V_{ce}(\text{sat})$  of the built-in photocoupler is approx. 1 V, the maximum number of connectable axes is limited. This  $V_{ce}(\text{sat})$  changes depending on the collector current. In addition, since approx. 5 mA per circuit is carried to SF input, as the number of connected axes increases, this current increases proportionally. It is required to limit the number of connected axes in order to prevent from exceeding the maximum output current on the safety controller side.



## 8-5 Safety precautions

- When using the STO function, be sure to perform equipment risk assessment to ensure that the system conforms to the safety requirements.  
For use in the state not satisfying the safety requirement function, in some cases personal injury may result.
- Even while the STO function is working, the following potential safety hazards exist. Check safety in risk assessment. Incorrect use may cause personal injury in some cases.
  - The motor may move when external force (e.g. gravity force on vertical axis) is exerted on it. Provide an external brake, etc., as necessary to secure the motor. Note that the purpose of servo motor with brake is holding and it cannot be used for braking application.
  - When parameter Pr5.10 “Sequence at alarm” is set to free run (disable dynamic brake), the motor is free run state and requires longer stop distance even if no external force is applied. Make sure that this does not cause any problem. (In STO state, even if an alarm does not occur, “Sequence at alarm” is applied.)
  - When power transistor, etc., becomes defective, the motor will move about 180 degrees in electrical angle. Make sure that this does not cause any problem.
  - The STO turns off the current to the motor but does not turn off power to the servo driver and does not isolate it. When starting maintenance service on the servo driver, turn off the driver by using a different disconnecting device.
- EDM output signal is not a safety output. Do not use it for an application other than failure monitoring. Incorrect use may cause personal injury in some cases.
- Dynamic brake and external brake release signal output are not related to safety function. When designing the system, make sure that the failure of external brake release during STO state does not result in danger condition. Incorrect use may cause personal injury in some cases.
- When using the STO function, connect equipment conforming to the safety standards. Use of equipment not compliant with safety standards, in some cases personal injury may result.

## 9. Other

## 9-1 List of parameters

The attribute of a parameter indicates the point at which the modified parameter setting becomes effective.

A : Always effective

B : Do not change while the motor is operating or command is transferred.

Changes while the motor is operating or command is transferred may result in transiently unstable operation and should be avoided as much as possible.

C : Effective after reset control power or after pin assign setting from PANATERM

R : Effective after reset control power

X : Read only - It cannot be changed using the normal procedure.

## 9-1-1 Class 0: Basic setting

Class	No.	Title	Unit	Range	Size [byte]	Function / Contents	Attribute	Related control mode	Reference
0	00	For manufacturer's use	—	—	2	Permanently set at 1.	—	—	—
	01	Control mode setup	—	0-6	2	Select the control mode of the servo driver. 0: semi-closed control (position/velocity/torque control, selectable) 1-5: To be used by the manufacturer but not by the user. 6: Full-closed control(Position control only) * The first edition of the software version (Ver1.01) does not support the setting value 6. * The set value 6 cannot be used for [A6BE]. Fix the value to 0.	R	All	—
	02	Real-time auto-gain tuning setup	—	0-6	2	You can set up the action mode of the real-time auto-gain tuning.	B	All	5-1-1 5-1-3 5-1-4
	03	Real-time auto-tuning machine stiffness setup	—	0-31	2	Set the machine stiffness during real-time auto-gain tuning.	B	All	5-1-1 5-1-3 5-1-4
	04	Inertia ratio	%	0-10000	2	You can set up the ratio of the load inertia against the rotor (of the motor) inertia.	B	All	—
	08	For manufacturer's use	—	—	4	Permanently set at 0.	—	—	—
	09	For manufacturer's use	—	—	4	Permanently set at 1.	—	—	—
	10	For manufacturer's use	—	—	4	Permanently set at 1.	—	—	—
	11	Number of output pulses per motor revolution	pulse/r	1-2097152	4	Set the number of output pulses per motor revolution for A-phase and B-phase respectively.	R	All	4-2-5
	12	Reversal of pulse output logic	—	0-3	2	Select the phase-B logic and output source for pulse regeneration output.	R	All	4-2-5
	13	1st torque limit	%	0-500	2	You can set up the 1st limit value of the motor output torque. The limit of parameter value is determined by the maximum torque of the motor connected.	B	All	6-1 7-4
	14	Position deviation excess setup	command unit	0-2 <sup>30</sup>	4	Set excess range of positional deviation by the command unit.Err24.0 (Error detection of position deviation excess) becomes invalid when it set up this to 0.Unit is according to Pr5.20 (Position setup unit select). The shipping set value is equivalent to 10 rotations when the command pulse per rotation is 23-bits.	A	Position, Full-close	7-4
	15	Absolute encoder setup	—	0-4	2	Select the use method of the absolute encoder. *1 0: Use as an absolute mode. 1: Use as an incremental mode. 2: Use as an absolute mode, but ignore the multi-turn counter over. 3: Use as an absolute mode, but not use multi-turn counter. (single-turn absolute mode) 4: Use as an absolute mode, but any value can be set for the upper limit of the multi-turn counter, and ignore the multi-turn counter over.(Continuous rotating absolute mode) *1 Absolute encoder will be handled as an incremental mode in internal control under full-closed control.	C	Position, Velocity, Torque	4-7-1 6-6 6-7
	16	External regenerative resistor setup	—	0-3	2	Set up items related to regenerative resistor. *1)	C	All	4-6
	17	Selection of load factor for external regenerative resistor	—	0-4	2	Select the computation method of loading factor for external regenerative resistor. *1)	C	All	4-6
	18	For manufacturer's use	-	-	2	Permanently set at 0.	-	-	-

\*1) Please do not change the shipment value setting with V frame.

## 9-1-2 Class 1: Gain adjustment

Class	No.	Title	Unit	Range	Size [byte]	Function / Contents	Attribute	Related control mode	Reference
1	00	1st gain of position loop	0.1/s	0-30000	2	Set the 1st gain of position loop.	B	Position, Full-closed	5-2
	01	1st velocity loop gain	0.1 Hz	1-32767	2	Set the 1st gain of velocity loop.	B	All	5-2
	02	1st velocity loop integration time constant	0.1 ms	1-10000	2	Set the 1st velocity loop integration time constant. Keep integration if setting value is 9999. Becomes invalid if setting value is 10000.	B	All	5-2
	03	1st filter of velocity detection	-	0-5	2	Set the 1st velocity detection filter to one of 6 levels.	B	All	5-2
	04	1st torque filter time constant	0.01 ms	0-2500	2	Set the time constant of the 1st torque filter.	B	All	5-2
	05	2nd gain of position loop	0.1/s	0-30000	2	Set the 2nd position loop gain.	B	Position, Full-closed	5-2
	06	2nd velocity loop gain	0.1 Hz	1-32767	2	Set the 2nd velocity proportional gain.	B	All	5-2
	07	2nd velocity loop integration time constant	0.1 ms	1-10000	2	Set the 2nd velocity integration time constant. Keep integration if setting value is 9999. Becomes invalid if setting value is 10000.	B	All	5-2
	08	2nd filter of velocity detection	-	0-5	2	Set the 2nd velocity detection filter to one of 6 levels.	B	All	5-2
	09	2nd torque filter time constant	0.01 ms	0-2500	2	Set the time constant of the 2nd torque filter.	B	All	5-2
	10	Velocity feed forward gain	0.1%	0-4000	2	Set the velocity feed forward gain.	B	Position, Full-closed	5-2-9
	11	Velocity feed forward filter	0.01 ms	0-6400	2	Set the time constant of velocity feed forward filter. *It becomes invalid in two-degree-of-freedom control mode.	B	Position, Full-closed	5-2-9
	12	Torque feed forward gain	0.1%	0-2000	2	Set the torque feed forward gain.	B	All	5-2-9
	13	Torque feed forward filter	0.01 ms	0-6400	2	Set the torque feed forward filter.	B	All	5-2-9
	14	2nd gain setup	-	0-1	2	Using the gain switching function, set this parameter for the best tuning.	B	All	5-2-5
	15	Mode of position control switching	-	0-10	2	Set the condition of gain switching for position control.	B	Position, Full-closed	5-2-5
	16	Delay time of position control switching	0.1 ms	0-10000	2	Set the delay time when switching from 2nd to 1st gain.	B	Position, Full-closed	5-2-5
	17	Level of position control switching	-	0-20000	2	Set the gain switching level.	B	Position, Full-closed	5-2-5
	18	Hysteresis at position control switching	-	0-20000	2	Set the hysteresis at gain switching.	B	Position, Full-closed	5-2-5
	19	Position gain switching time	0.1 ms	0-10000	2	Set the position gain switching time upon gain switching.	B	Position, Full-closed	5-2-5
	20	Mode of velocity control switching	-	0-5	2	Set the condition of gain switching for velocity control	B	Velocity	5-2-5
	21	Delay time of velocity control switching	0.1 ms	0-10000	2	Set the delay time when switching from 2nd to 1st gain.	B	Velocity	5-2-5
	22	Level of velocity control switching	-	0-20000	2	Set the gain switching level.	B	Velocity	5-2-5
	23	Hysteresis at velocity control switching	-	0-20000	2	Set the hysteresis at gain switching.	B	Velocity	5-2-5
	24	Mode of torque control switching	-	0-3	2	Set the condition of gain switching for torque control	B	Torque	5-2-5
	25	Delay time of torque control switching	0.1 ms	0-10000	2	Set the delay time when switching from 2nd to 1st gain.	B	Torque	5-2-5
	26	Level of torque control switching	-	0-20000	2	Set the gain switching level.	B	Torque	5-2-5
27	Hysteresis at torque control switching	-	0-20000	2	Set the hysteresis at gain switching.	B	Torque	5-2-5	

(To be continued)



## 9-1-3 Class 2: Damping control

Class	No.	Title	Unit	Range	Size [byte]	Function / Contents	Attribute	Related control mode	Reference
2	00	Adaptive filter mode setup	-	0-6	2	Set the operation of adaptive filter.	B	Position, Velocity, Full-closed	5-1-2
	01	1st notch frequency	Hz	50-5000	2	Set the notch frequency of 1st resonance suppression notch filter. Set the notch frequency to the resonance frequency of the machine.	B	All	5-2-6
	02	1st notch width selection	-	0-20	2	Set the notch width of 1st resonance suppression notch filter.	B	All	5-2-6
	03	1st notch depth selection	-	0-99	2	Set the notch depth of 1st resonance suppression notch filter.	B	All	5-2-6
	04	2nd notch frequency	Hz	50-5000	2	Set the notch frequency of 2nd resonance suppression notch filter. Set the notch frequency to the resonance frequency of the machine.	B	All	5-2-6
	05	2nd notch width selection	-	0-20	2	Set the notch width of 2nd resonance suppression notch filter.	B	All	5-2-6
	06	2nd notch depth selection	-	0-99	2	Set the notch depth of 2nd resonance suppression notch filter.	B	All	5-2-6
	07	3rd notch frequency	Hz	50-5000	2	Set the notch frequency of 3rd resonance suppression notch filter. Set the notch frequency to the resonance frequency of the machine. Automatically set when the adaptive notch is enabled.	B	All	5-1-2 5-2-6
	08	3rd notch width selection	-	0-20	2	Set the notch width of 3rd resonance suppression notch filter. Automatically set when the adaptive notch is enabled.	B	All	5-1-2 5-2-6
	09	3rd notch depth selection	-	0-99	2	Set the notch depth of 3rd resonance suppression notch filter. Automatically set when the adaptive notch is enabled.	B	All	5-1-2 5-2-6
	10	4th notch frequency	Hz	50-5000	2	Set the notch frequency of 4th resonance suppression notch filter. Set the notch frequency to the resonance frequency of the machine. Automatically set when the adaptive notch is enabled.	B	All	5-1-2 5-2-6
	11	4th notch width selection	-	0-20	2	Set the notch width of 4th resonance suppression notch filter. Automatically set when the adaptive notch is enabled.	B	All	5-1-2 5-2-6
	12	4th notch depth selection	-	0-99	2	Set the notch depth of 4th resonance suppression notch filter. Automatically set when the adaptive notch is enabled.	B	All	5-1-2 5-2-6
	13	Selection of damping filter switching	-	0-6	2	Select the filters to be used for damping control.	B	Position, Full-closed	5-2-7
	14	1st damping frequency	0.1 Hz	0-3000	2	You can set up the 1st damping frequency of the damping control which suppresses vibration at the load edge. Setting value of 5 (= 0.5 Hz) or higher is valid.	B	Position, Full-closed	5-2-7
	15	1st damping filter setup	0.1 Hz	0-1500	2	Fine tune the 1st filter damping control. Decrease the setting value to avoid torque saturation or increase the value to improve the response.	B	Position, Full-closed	5-2-7
	16	2nd damping frequency	0.1 Hz	0-3000	2	You can set up the 2nd damping frequency of the damping control which suppresses vibration at the load edge. Setting value of 5 (= 0.5 Hz) or higher is valid.	B	Position, Full-closed	5-2-7
	17	2nd damping filter setup	0.1 Hz	0-1500	2	Fine tune the 2nd filter damping control. Decrease the setting value to avoid torque saturation or increase the value to improve the response.	B	Position, Full-closed	5-2-7
	18	3rd damping frequency	0.1 Hz	0-3000	2	You can set up the 3rd damping frequency of the damping control which suppresses vibration at the load edge. Setting value of 5 (= 0.5 Hz) or higher is valid.	B	Position, Full-closed	5-2-7
	19	3rd damping filter setup	0.1 Hz	0-1500	2	Fine tune the 3rd filter damping control. Decrease the setting value to avoid torque saturation or increase the value to improve the response.	B	Position, Full-closed	5-2-7
	20	4th damping frequency	0.1 Hz	0-3000	2	You can set up the 4th damping frequency of the damping control which suppresses vibration at the load edge. Setting value of 5 (= 0.5 Hz) or higher is valid.	B	Position, Full-closed	5-2-7
21	4th damping filter setup	0.1 Hz	0-1500	2	Fine tune the 4th filter damping control. Decrease the setting value to avoid torque saturation or increase the value to improve the response.	B	Position, Full-closed	5-2-7	

(To be continued)

## Class 2: Damping control

Class	No.	Title	Unit	Range	Size [byte]	Function / Contents	Attribute	Related control mode	Reference
2	22	Positional command smoothing filter	0.1 ms	0-10000	2	<p>[For position control,full-closed control]</p> <ul style="list-style-type: none"> <li>For conventional control (Pr 6.47 bit 0 = 0) Will set time constant of primary delay filter against position command.</li> <li>2 degrees of freedom control (Pr 6.47 bit 0 = 1) Will be set to time constant of command response filter. Maximum value is limited to 2,000 (=200.0 ms) *1</li> </ul> <p>[For velocity control]</p> <ul style="list-style-type: none"> <li>For conventional control (Pr 6.47 bit 0 = 0) This setting will be ignored.</li> <li>2 degrees of freedom control (Pr 6.47 bit 0 = 1) Will be set to time constant of command response filter. Maximum value is limited to 640 (= 64.0 ms) *1</li> </ul> <p>*1: The value of the parameter itself will not be limited but the value to be applied will be limited within the driver. Attenuation term can be set at Pr 6.49 "Adjust/Torque command attenuation term".</p>	B	Position, Velocity, Full-closed	4-2-3 5-2-16 5-2-17 5-2-18
	23	Positional command FIR filter	0.1 ms	0-10000	2	Set the time constant of the FIR filter in response to the positional command.	B	Position, Full-closed	4-2-3
	24	5th notch frequency	Hz	50-5000	2	Set the notch frequency for the 5th resonance suppression notch filter. Set the notch frequency to the resonance frequency of the machine.	B	All	5-2-6
	25	5th notch width selection	-	0-20	2	Set the notch width for the 5th resonance suppression notch filter.	B	All	5-2-6
	26	5th notch depth selection	-	0-99	2	Set the notch depth for the 5th resonance suppression notch filter.	B	All	5-2-6
	27	1st damping width setting	-	0-1000	2	Fine tune the 1st damping control function.	B	Position, Full-closed	5-2-7
	28	2nd damping width setting	-	0-1000	2	Fine tune the 2nd damping control function.	B	Position, Full-closed	5-2-7
	29	3rd damping width setting	-	0-1000	2	Fine tune the 3rd damping control function.	B	Position, Full-closed	5-2-7
	30	4th damping width setting	-	0-1000	2	Fine tune the 4th damping control function.	B	Position, Full-closed	5-2-7
	31	For manufacturer's use	-	-	2	Permanently set at 0.	-	-	-
	32	For manufacturer's use	-	-	2	Permanently set at 0.	-	-	-
	33	For manufacturer's use	-	-	2	Permanently set at 0.	-	-	-
	34	For manufacturer's use	-	-	2	Permanently set at 0.	-	-	-
	35	For manufacturer's use	-	-	2	Permanently set at 0.	-	-	-
	36	For manufacturer's use	-	-	2	Permanently set at 0.	-	-	-
	37	For manufacturer's use	-	-	2	Permanently set at 0.	-	-	-

## 9-1-4 Class 3: Velocity/ Torque/ Full-closed control

Class	No.	Title	Unit	Range	Size [byte]	Function / Contents	Attribute	Related control mode	Reference
3	04	For manufacturer's use	—	—	2	Permanently set at 0.	—	—	—
	05	For manufacturer's use	—	—	2	Permanently set at 0.	—	—	—
	12	Acceleration time setup	ms/ (1000 r/min)	0–10000	2	Set the acceleration processing time in response to the velocity instruction input.	B	Velocity	4-3-3
	13	Deceleration time setup	ms/ (1000 r/min)	0–10000	2	Set the deceleration processing time in response to the velocity instruction input.	B	Velocity	4-3-3
	14	Sigmoid acceleration/ deceleration time setup	ms	0–1000	2	Set the S-curve time for acceleration/deceleration process when the velocity instruction is applied.	B	Velocity	4-3-3
	17	Selection of speed limit	—	2	2	Set the speed limit	B	Torque	4-4-1
	21	For manufacturer's use	—	—	2	Permanently set at 0.	—	—	—
	22	For manufacturer's use	—	—	2	Permanently set at 0.	—	—	—
	23	External scale selection	—	0–6	2	Select the type of external scale. 0: A,B phase output type 1: Serial communication type (incremental specification) 2: Serial communication type (absolute specification) 3-5 : For manufacturer's use 6 : Serial communication type (absolute specification) It is not supported in function extended edition 2 and earlier versions.	R	All	4-8
	24	Numerator of external scale division	—	0–2 <sup>23</sup>	4	Set up the numerator of the external scale dividing setup. When the set value = 0, the operation is performed with the encoder resolution used as the division numerator.	R	Full-closed	4-5-2
	25	Denominator of external scale division	—	1–2 <sup>23</sup>	4	Set up the denominator of the external scale dividing setup.	R	Full-closed	4-5-2
	26	Reversal of direction of external scale	—	0–3	2	Set up the polarity for external scale feedback pulse.	R	All	4-8
	27	External scale Z phase disconnection detection disable	—	0–1	2	Validate/Invalidate Z-phase disconnection detection when using AB phase output type external scale. 0: Valid, 1: Invalid	R	All	4-8
	28	Hybrid deviation excess setup	Command unit	1–2 <sup>27</sup>	4	Set the threshold of Err.25.0 (Hybrid deviation excess error protection).	C	Full-closed	4-5-3 7-4
	29	Hybrid deviation clear setup	Revolution	0–100	2	Clear hybrid deviation of each revolution setting to zero.	C	Full-closed	4-5-3
	33	For manufacturer's use	—	—	2	Permanently set at 0.	—	—	—
34	For manufacturer's use	—	—	2	Permanently set at 0.	—	—	—	
35	For manufacturer's use	—	—	2	Permanently set at 0.	—	—	—	
36	For manufacturer's use	—	—	2	Permanently set at 0.	—	—	—	

## 9-1-5 Class 4: I/O monitor setting

Class	No.	Title	Unit	Range	Size [byte]	Function / Contents	Attribute	Related control mode	Reference
4	00	SI1 input selection	—	0-00FFFFFFh	4	Set function and logic of SI1.	C	All	2-4-1
	01	SI2 input selection	—	0-00FFFFFFh	4	Set function and logic of SI2.	C	All	2-4-1
	02	SI3 input selection	—	0-00FFFFFFh	4	Set function and logic of SI3.	C	All	2-4-1
	03	SI4 input selection	—	0-00FFFFFFh	4	Set function and logic of SI4.	C	All	2-4-1
	04	SI5 input selection	—	0-00FFFFFFh	4	Set function and logic of SI5.	C	All	2-4-1
	05	SI6 input selection	—	0-00FFFFFFh	4	Set function and logic of SI6.	C	All	2-4-1
	06	SI7 input selection	—	0-00FFFFFFh	4	Set function and logic of SI7.	C	All	2-4-1
	07	SI8 input selection	—	0-00FFFFFFh	4	Set function and logic of SI8.	C	All	2-4-1
	10	SO1 output selection	—	0-00FFFFFFh	4	Set SO1 function allocation.	C	All	2-4-2
	11	SO2 output selection	—	0-00FFFFFFh	4	Set SO2 function allocation.	C	All	2-4-2
	12	SO3 output selection	—	0-00FFFFFFh	4	Set SO3 function allocation.*2)	C	All	2-4-2
	16	Type of analog monitor 1	—	0-30 *1)	2	Select the type of monitor for analog monitor 1.*2)	A	All	3-4
	17	Analog monitor 1 output gain	—	0-214748364	4	Set the output gain of analog monitor 1. *2)	A	All	3-4
	18	Type of analog monitor 2	—	0-30 *1)	2	Select the type of monitor for analog monitor 2. *2)	A	All	3-4
	19	Analog monitor 2 output gain	—	0-214748364	4	Set the output gain of analog monitor 2. *2)	A	All	3-4
	21	Analog monitor output setup	—	0-2	2	Select output voltage format of the analog monitor. *2)	A	All	3-4
	22	For manufacturer's use	—	—	2	Permanently set at 0.	—	—	—
	23	For manufacturer's use	—	—	2	Permanently set at 0.	—	—	—
	24	For manufacturer's use	—	—	2	Permanently set at 0.	—	—	—
	31	Positioning complete (In-position) range	Command unit	0-2097152	4	Set allowable the number of pulses for positioning complete signal (INP). Unit is according to Pr5.20 "Position setup unit select".	A	Position, Full-closed	4-2-4
	32	Positioning complete (In-position) output setup	-	0-10	2	Set the condition for positioning complete output.	A	Position, Full-closed	4-2-4
	33	INP hold time	ms	0-30000	2	Set the INP hold time	A	Position, Full-closed	4-2-4
	34	Zero-speed	r/min	10-20000	2	Set threshold for zero speed (ZSP) detection.	A	All	2-4-2
	35	Speed coincidence range	r/min	10-20000	2	Set the detection threshold of speed coincidence output (V-COIN) by the difference between the velocity command and the actual speed.	A	Velocity, Torque	4-3-2
36	At-speed (Speed arrival)	r/min	10-20000	2	Set the detection timing of the speed arrival output (AT-SPEED).	A	Velocity, Torque	4-3-1	
37	Mechanical brake action at stalling setup	ms	0-10000	2	Set the mechanical brake operating time at stalling.	B	All	9-2-2	
38	Mechanical brake action at running setup	ms	0-32000	2	Set the mechanical brake operating time at running.	B	All	6-3-7 8-3-1 9-2-3 9-2-4 9-2-5	

\*1) In the enhanced version 6 and earlier, the setting range is 0 to 28.

\*2) Please do not change the shipment value setting with V frame.

(To be continued)



## Class 4: I/O monitor setting

Class	No.	Title	Unit	Range	Size [byte]	Function / Contents	Attribute	Related control mode	Reference
4	39	Brake release speed setup	r/min	30-3000	2	Set the speed timing for judgement of mechanical brake output during operation.	B	All	8-3-1 9-2-3 9-2-4 9-2-5
	40	Selection of alarm output 1	—	0-40	2	Select the type of warning issued as the alarm output 1.	A	All	7-3
	41	Selection of alarm output 2	—	0-40	2	Select the type of warning issued as the alarm output 2.	A	All	7-3
	42	Positioning complete (In-position) range 2	Command unit	0-2097152	4	Set the acceptable number of pulses for positioning complete signal 2 (INP2). Unit is according to Pr5.20 "Position setup unit select".	A	Position Full-closed	4-2-4
	44	Position comparison output pulse width setting	0.1ms	0-32767	2	Set the pulse width of the signal that is output for position comparison. The signal is not output when 0 is set.	R	All	6-5
	45	Position comparison output polarity selection	-	0-7	2	Set the polarity of position comparison output by bit setup for each output terminal. • Setup bits bit0: SO1,OCMP1 bit1: SO2,OCMP2 bit2: SO3,OCMP3 • Setup values of each setting bit 0: The output photocoupler is turned ON for SO1 to 3 and is set to L level for OCMP1 to 3, respectively, during pulse output. 1: The output photocoupler is turned OFF for SO1 to 3 and is set to H level for OCMP1 to 3, respectively, during pulse output. Basically, use this function as 0. ※Do not use SO3 with V frame.	R	All	6-5
	47	Pulse output selection	-	0-1	2	Select the signal to be output from the pulse generation output terminal or Position comparison output terminal. 0: Encoder output signal 1: Position comparison output signal	R	All	4-2-5 6-5
	48	Position comparison value 1	Command unit	-2147483648 -2147483647	4	Set the comparison value for position comparison output 1.	A	All	6-5
	49	Position comparison value 2	Command unit	-2147483648 -2147483647	4	Set the comparison value for position comparison output 2.	A	All	6-5
	50	Position comparison value 3	Command unit	-2147483648 -2147483647	4	Set the comparison value for position comparison output 3.	A	All	6-5
	51	Position comparison value 4	Command unit	-2147483648 -2147483647	4	Set the comparison value for position comparison output 4.	A	All	6-5
	52	Position comparison value 5	Command unit	-2147483648 -2147483647	4	Set the comparison value for position comparison output 5.	A	All	6-5
	53	Position comparison value 6	Command unit	-2147483648 -2147483647	4	Set the comparison value for position comparison output 6.	A	All	6-5
	54	Position comparison value 7	Command unit	-2147483648 -2147483647	4	Set the comparison value for position comparison output 7.	A	All	6-5
	55	Position comparison value 8	Command unit	-2147483648 -2147483647	4	Set the comparison value for position comparison output 8.	A	All	6-5
	56	Position comparison output delay compensation amount	0.1us	-32768 -32767	2	Compensate the delay in the position comparison output signaled by the circuit.	R	All	6-5

(To be continued)

## Class 4: I/O monitor setting

Class	No.	Title	Unit	Range	Size [byte]	Function / Contents	Attribute	Related control mode	Reference
4	57	Position comparison output assignment setting	-	-2147483648 -2147483647	4	<p>Set the output terminals corresponding to position comparison values 1 to 8 by bit setup. Multiple position comparison values can be set up on one output terminal.</p> <ul style="list-style-type: none"> <li>• Setup bits <ul style="list-style-type: none"> <li>bit0 to 3 : Position comparison output 1</li> <li>bit4 to 7 : Position comparison output 2</li> <li>bit8 to 11 : Position comparison output 3</li> <li>bit12 to 15 : Position comparison output 4</li> <li>bit16 to 19 : Position comparison output 5</li> <li>bit20 to 23 : Position comparison output 6</li> <li>bit24 to 27 : Position comparison output 7</li> <li>bit28 to 31 : Position comparison output 8</li> </ul> </li> <li>• Setup values of each setting bit <ul style="list-style-type: none"> <li>0000b : Output disabled</li> <li>0001b : Assigned to SO1,OCMP1</li> <li>0010b : Assigned to SO2,OCMP2</li> <li>0011b : Assigned to SO3,OCMP3</li> </ul> </li> </ul> <p>Other than above: For manufacturer's use (Do not set.)</p> <p>※Do not use SO3 with V frame.</p>	R	All	6-5

9-1-6 Class 5: Enhancing setting										
Class	No.	Title	Unit	Range	Size [byte]	Function / Contents	Attribute	Related control mode	Reference	
5	03	Denominator of pulse output division	—	0–8388608	4	Use this setting when specifying No. of output pulses/motor revolution by the ratio of numerator and denominator of division.	R	All	4-2-5	
	04	Over-travel inhibit input setup	—	0–2	2	Set the operation of the inhibit positive/negative direction travel inputs.	C	All	6-3-1 7-4 7-5	
	05	Sequence at over-travel inhibit	—	0–2	2	Set the sequence when over-travel inhibit is input.	C	All	6-3-1 7-4	
	06	Sequence at Servo-Off	—	0–9	2	Set the sequence while servo is OFF.	B	All	6-3-2	
	07	Sequence upon main power off	—	0–9	2	Set the sequence while main AC power is OFF. *2)	B	All	6-3-3	
	08	L/V trip selection upon main power off	—	0–3	2	Select L/V trip or servo OFF upon occurrence of main AC power alarm. Setup the condition to detect main AC power OFF alarm when the main AC power is kept interrupted for a time longer than the time set by Pr7.14. *2) bit0 0:The servo off according to the setting of 6007h(Abort connection option code) or Pr5.07. 1: Trip with Err 13.1 Main power undervoltage protection. bit 1 0: Detect main AC power OFF alarm only when servo is in ON state. 1: Always detect main AC power OFF alarm.	B	All	6-3-3	
	09	Detection time of main power off	1 ms	20~2000 *1)	2	Set the main AC power alarm detection time. Main AC power OFF detection is disabled when the setting value is 2000. *2)	C	All	6-3-3	
	10	Sequence at alarm	—	0–7	2	Set the sequence used upon occurrence of an alarm.	B	All	6-3-4 6-3-5 6-3-6	
	11	Torque setup for emergency stop	%	0–500	2	Set up the torque limit at emergency stop. When setup value is 0, the torque limit for normal operation is applied.	B	All	6-3-1 6-3-2 6-3-3 6-3-5	
	12	Over-load level setup	%	0–500	2	You can set up the over-load level. It becomes 115% by setting up this to 0. The setup value of this parameter is limited by 115% of the motor rating.	A	All	—	
	13	Over-speed level setup	r/min	0–20000	2	Set the detection level for Err26.0 Oversy rate protection. Err26.0 "Oversy rate protection" occurs when the motor speed exceeds this set value.If the setting value is 0, it is an oversleed level in the applied motor. In addition, the internal value is limited by the oversce rate level in the applied motor. *1 *1 Excluding some motors.	B	All	6-3-5 7-4	
	14	Motor working range setup	0.1 rot	0–1000	2	You can set up the movable range of the motor against the position command input range.When the motor movement exceeds the setup value, Err34.0 "software limit protection" will be triggered.When set value of this parameter is 0, Err34.0 become disable. Also in condisions written in section 6-2 (2) Caution, Err34.0 become disable.	A	Position, Full-closed	6-2 7-4	
	15	Control input signal reading setup	—	0–3	2	Set up a read signal for cycle of the control input. 0:0.250ms,1:0.500ms,2:1.000ms,3:2.000ms However, the following are exceptions. - When using POT/NOT/HOME as the home position reference trigger - The external latch input1/2(EXT1/2) (Note) Read cycle differs from MINAS-A5B series.	C	All	—	
	16	For manufacturer's use	—	—	2	Permanently set at 1.	—	—	—	
	5	20	Position setup unit select	—	0–1	2	Specify the unit to determine the range of positioning complete and excessive positional deviation.0: Command unit, 1: Encoder unit (External scale unit) Note: Positioning complete(6041h bit10(Target reached)) detection threshold of EtherCAT communication status is always command unit regardless of the setting of this parameter.	C	Position, Full-closed	4-2-4 7-4

\*1) To use this setting with a smaller value than the shipment value, please check matching with your power supply environment.

\*2) Please do not change the shipment value setting with V frame.

(To be continued)

## Class 5: Enhancing setting

Class	No.	Title	Unit	Range	Size [byte]	Function / Contents	Attribute	Related control mode	Reference
5	21	Selection of torque limit	—	0–5 *1)	2	Select positive direction or negative direction torque limit. When 0 is set, 1 will be internally set. Only the setting Pr5.21=5 becomes enabled during torque control. When Pr5.21=1 to 4, Pr0.13 is applied to the torque limit.	B	All	6-1
	22	2nd torque limit	%	0–500	2	You can set up the 2nd limit value of the motor output torque. The value of parameter is limited to the maximum torque of the applicable motor.	B	Position, Velocity, Full-closed	6-1
	25	For manufacturer's use	—	—	2	Permanently set at 0.	—	—	—
	26	For manufacturer's use	—	—	2	Permanently set at 0.	—	—	—
	29	For manufacturer's use	—	—	2	Permanently set at 2.	—	—	—
	31	USB axis address	—	0–127	2	Set up the axis number for USB communication.	R	All	—
	33	Pulse regenerative output limit setup	—	0–1	2	Enable/disable detection of Err 28.0 "Pulse regenerative limit protection". 0: Invalid 1: Valid	C	All	4-2-5
	34	For manufacturer's use	—	—	2	Permanently set at 4.	—	—	—
	36	For manufacturer's use	—	—	2	Permanently set at 0.	—	—	—
	45	Quadrant glitch positive-direction compensation value	0.1%	-1000–1000	2	Set the positive-direction high-precision torque compensation value for quadrant glitches.	B	Position, Full-closed	5-2-15
	46	Quadrant glitch negative-direction compensation value	0.1%	-1000–1000	2	Set the negative-direction high-precision torque compensation value for quadrant glitches.	B	Position, Full-closed	5-2-15
	47	Quadrant glitch compensation delay time	ms	0–1000	2	Set the compensation timing delay time for quadrant glitches.	B	Position, Full-closed	5-2-15
	48	Quadrant glitch compensation filter setting L	0.01 ms	0–6400	2	Set the compensation value LPF time constant for quadrant glitches.	B	Position, Full-closed	5-2-15
	49	Quadrant glitch compensation filter setting H	0.1 ms	0–10000	2	Set the compensation value HPF time constant for quadrant glitches.	B	Position, Full-closed	5-2-15
	50	For manufacturer's use	—	—	4	Permanently set at 0.	—	—	—
	51	For manufacturer's use	—	—	4	Permanently set at 0.	—	—	—
	52	For manufacturer's use	—	—	4	Permanently set at 0.	—	—	—
	53	For manufacturer's use	—	—	4	Permanently set at 0.	—	—	—
	54	For manufacturer's use	—	—	4	Permanently set at 0.	—	—	—
	55	For manufacturer's use	—	—	4	Permanently set at 0.	—	—	—
	56	Slow stop deceleration time setting	ms/ (1000 r/min)	0 – 10000	2	Sets deceleration time for slow stop deceleration processing. This parameter will become valid when Pr6.10 "Function expansion setup" bit 15 = 1	B	Position, Velocity, Torque	6-3-7
	57	Slow stop S-shape acceleration and deceleration setting	ms	0 – 1000	2	Sets the S-shape time for slow stop deceleration processing. This parameter will become valid when Pr6.10 "Function expansion setup" bit 15 = 1	B	Position, Velocity, Torque	6-3-7
	66	Deterioration diagnosis convergence judgment time	0.1s	0 – 10000	2	Sets time for deemed convergence of real-time auto tuning load characteristics estimate when deterioration diagnosis warning function is valid (Pr6.97 bit 1 = 1) When the set value is 0, it will be set automatically inside the driver in accordance with Pr6.31 "Real time auto tuning estimation speed". * When Pr6.31 "Real time auto tuning estimation speed" = 0, the deterioration diagnosis warning judgment for load characteristics estimate will be invalid.	A	All	6-8

\*1) The setting range is 0 to 4 in function extended version 2 and earlier versions.

(To be continued)

## Class 5: Enhancing setting

Class	No.	Title	Unit	Range	Size [byte]	Function / Contents	Attribute	Related control mode	Reference
5	67	Deterioration diagnosis inertia ratio upper limit	%	0 – 10000	2	Sets the upper and lower limit values for inertia ratio estimate in deterioration diagnosis judgment of load characteristics estimate after completion of convergence, when deterioration diagnosis warning is valid (Pr6.97 bit 1 = 1). * When the upper limit value is set at 10000 (max. value), judgment of the upper limit becomes invalid.	A	All	6-8
	68	Deterioration diagnosis inertia ratio lower limit	%	0– 10000	2	* When the lower limit value is set at 0 (min. value), judgment of the lower limit becomes invalid. * If Pr5.67 (upper limit) ≤ Pr5.68 (lower limit), judgment of both the upper limit and lower limit becomes invalid. * The set resolution shall be in units of 0.2%.	A	All	6-8
	69	Deterioration diagnosis unbalanced load upper limit	0.1%	-1000 – 1000	2	Sets the upper and lower limit values for unbalanced load estimate in deterioration diagnosis judgment of load characteristics estimate after completion of convergence, when deterioration diagnosis warning is valid (Pr6.97 bit 1 = 1). * When the upper limit value is set at 1000 (max. value), judgment of the upper limit becomes invalid.	A	All	6-8
	70	Deterioration diagnosis unbalanced load lower limit	0.1%	-1000 – 1000	2	* When the lower limit value is set at -1000 (min. value), judgment of the lower limit becomes invalid. * If Pr5.69 (upper limit) ≤ Pr5.70 (lower limit), judgment of both the upper limit and lower limit becomes invalid. * The set resolution shall be in units of 0.2%.	A	All	6-8
	71	Deterioration diagnosis dynamic friction upper limit	0.1%	-1000 – 1000	2	Sets the upper and lower limit values for dynamic friction estimate in deterioration diagnosis judgment of load characteristics estimate after completion of convergence, when deterioration diagnosis warning is valid (Pr6.97 bit 1 = 1). * When the upper limit value is set at 1000 (max. value), judgment of the upper limit becomes invalid.	A	All	6-8
	72	Deterioration diagnosis dynamic friction lower limit	0.1%	-1000 – 1000	2	* When the lower limit value is set at -1000 (min. value), judgment of the lower limit becomes invalid. * If Pr5.71 (upper limit) ≤ Pr5.72 (lower limit), judgment of both the upper limit and lower limit becomes invalid. * The set resolution shall be in units of 0.2%.	A	All	6-8
	73	Deterioration diagnosis viscous friction upper limit	0.1% / (10000r /min)	0– 10000	2	Sets the upper and lower limit values for viscous friction coefficient estimate in deterioration diagnosis judgment of load characteristics estimate after completion of convergence, when deterioration diagnosis warning is valid (Pr6.97 bit 1 = 1). * When the upper limit value is set at 10000 (max. value), judgment of the upper limit becomes invalid.	A	All	6-8
	74	Deterioration diagnosis viscous friction lower limit	0.1% / (10000r /min)	0– 10000	2	* When the lower limit value is set at 0 (min. value), judgment of the lower limit becomes invalid. * If Pr5.73 (upper limit) ≤ Pr5.74 (lower limit), judgment of both the upper limit and lower limit becomes invalid. * The set resolution shall be in units of 0.2%.	A	All	6-8
	75	Deterioration diagnosis velocity setting	r/min	-20000 – 20000	2	Outputs deterioration diagnosis velocity output (V-DIAG) when the motor velocity is in the range of Pr5.75±Pr4.35 (velocity coinciding width), when deterioration diagnosis warning is valid (Pr6.97 bit 1 = 1) * Deterioration diagnosis velocity output has a 10 [r/min] hysteresis.	A	All	6-8

(To be continued)

## Class 5: Enhancing setting

Class	No.	Title	Unit	Range	Size [byte]	Function / Contents	Attribute	Related control mode	Reference
5	76	Deterioration diagnosis torque average time	ms	0-10000	2	Sets time required to compute the torque command average (weighted frequency) when deterioration diagnosis warning is valid (Pr6.97 bit 1 = 1) and diagnosis velocity output (V-DIAG) is ON. * Time from diagnosis velocity output (V-DIAG) ON to the start judgment for upper and lower value of torque command average value is also a part of the set time for this parameter. *If the setting value is 0, the torque command average value is not calculated.	A	All	6-8
	77	Deterioration diagnosis torque upper limit	0.1%	-1000 - 1000	2	Sets the upper and lower limit values for torque command average value when deterioration diagnosis warning is valid (Pr6.97 bit 1 = 1) and deterioration diagnosis velocity output (V-DIAG) is ON * When the upper limit value is set at 1000 (max. value), judgment of the upper limit becomes invalid.	A	All	6-8
	78	Deterioration diagnosis torque lower limit	0.1%	-1000 - 1000	2	* When the lower limit value is set at -1000 (min. value), judgment of the lower limit becomes invalid. * If Pr5.77 (upper limit) ≤ Pr5.78 (lower limit), judgment of both the upper limit and lower limit becomes invalid.	A	All	6-8
	96	For manufacturer's use	—	—	2	Please do not change the shipment value.	—	—	—
	97	For manufacturer's use	—	—	2	Please do not change the shipment value.	—	—	—

## 9-1-7 Class 6: Special setting

Class	No.	Title	Unit	Range	Size [byte]	Function / Contents	Attribute	Related control mode	Reference
6	02	Speed deviation excess setup	r/min	0-20000	2	Set threshold of Err 24.1 Speed over deviation protection. This protection is not detected when the setup value is 0.	A	Position	—
	05	Position 3rd gain valid time	0.1 ms	0-10000	2	Set up 3rd gain valid time of 3 gain level adjustment.	B	Position, Full-closed	5-2-11
	06	Position 3rd gain scale factor	%	50-1000	2	Set up the 3rd gain by a multiplying factor of the 1st gain	B	Position, Full-closed	5-2-11
	07	Torque command additional value	%	-100-100	2	Set up the offset torque to be added to the torque command.	B	Position, Velocity, Full-closed	5-2-12
	08	Positive direction torque compensation value	%	-100-100	2	Set up the value to be added to the torque command for positive direction operation.	B	Position, Full-closed	5-2-12
	09	Negative direction torque compensation value	%	-100-100	2	Set up the value to be added to the torque command for negative direction operation.	B	Position, Full-closed	5-2-12
	10	Function expansion setup	—	-32768-32768	2	Set up the function in unit of bit. bit0 unused. Always set to 0. bit1 Load variation suppression function 0:Invalid 1:Valid bit2 Load variation stabilization setting 0:Invalid 1:Valid. bit3 For manufacturer's use. Always set to 0. bit4 Current response improvement 0:Invalid 1: Valid bit5 For manufacturer's use. Always set to 0. bit6-8 unused. Always set to 0. bit9 For manufacturer's use. Always set to 1. bit10 Fall prevention function in case of alarms 0:Invalid 1: Valid bit11 Encoder overheat error protection detection 0: Invalid 1: Valid *1 bit12 unused. Always set to 0. bit13 For manufacturer's use. Always set to 0. bit14 Load variation suppression function automatic setting 0: Invalid 1: Valid *2 bit15 Slow stop function 0: Invalid 1: Valid *bit 0 is the least significant bit. *1 When an encoder overheat warning occurs, Err15.1 "Encoder overheat error protection" also occurs concurrently. *2 When bit14 to 1, it will be bit1 and 2 also 1.	B	All	5-1-1 5-1-3 5-1-4 5-2-10 6-3-6 6-3-7
	11	Current response setup	%	10-300	2	Adjust the current response with the level set at shipment as 100%. In principle, specify 100 for this setting and adjust the position/velocity gain. While the response can be improved by setting this value to a value larger than 100 when it is wished that the servo response is further improved, it may also result in a tendency for vibration and noise generation. Adjust it to an appropriate value depending on the operating conditions of the applied device in a similar fashion to the adjustment of position/velocity gain. The maximum value which can be set varies by the type of motor connected, and the maximum value is limited to 100% for some of the motors. (Note) The setting range is 10 to 100% for function extended edition 3 and earlier versions.	B	All	—
	14	Emergency stop time at alarm	ms	0-1000	2	Set up the time allowed to complete emergency stop in an alarm condition.	B	All	6-3-5 6-3-7 9-2-5
	15	2nd over-speed level setup	r/min	0-20000	2	When the motor speed exceeds this setup time during emergency stop sequence in an alarm condition, Err 26.1 2nd over-speed protection will be activated. When setup value is 0, the over-speed level becomes internal value of the over-speed protection level speed.	B	All	6-3-5

(To be continued)

## Class 6: Special setting

Class	No.	Title	Unit	Range	Size [byte]	Function / Contents	Attribute	Related control mode	Reference
6	18	Power-up wait time	0.1 s	0-100	2	Set up the standard initialization time approx. $1.5 \text{ s} + \alpha(\text{setting value} \times 0.1 \text{ s})$ after power-up. For example, in the case of the preset value 10, it is set to $1.5 \text{ s} + (10 \times 0.1 \text{ s}) = \text{approx. } 2.5 \text{ s}$ . * If the period until LINK establishment is too long, it may be possible to improve this phenomenon by setting different values in the Pr6.18 for adjacent servo drivers (such as 0.0 s and 0.1 s).	R	All	3-3 9-2-1
	19	For manufacturer's use	—	—	2	Permanently set at 0.	—	—	—
	20	For manufacturer's use	—	—	2	Permanently set at 0.	—	—	—
	21	For manufacturer's use	—	—	4	Permanently set at 0.	—	—	—
	22	AB phase external scale pulse outputting method selection	—	0-1	2	Select regeneration method of OA and OB pulse output when using AB phase output type external scale. 0: Signal is not regenerated 1: Signal is regenerated • When signal regeneration is selected, the driver reproduces duty of OA and OB, minimizing waveform distortion.	R	Full-closed	4-2-5
	23	Load change compensation gain	%	-100-100	2	Set the compensation gain for a load change.	B	Position, Velocity, Full-closed	5-2-10
	24	Load change compensation filter	0.01 ms	10-2500	2	Set the filter time constant for a load change.	B	Position, Velocity, Full-closed	5-2-10
	25	For manufacturer's use	—	—	2	Please do not change the shipment value.	—	—	—
	26	For manufacturer's use	—	—	4	Please do not change the shipment value.	—	—	—
	27	Warning latch state setup	—	0-3	2	Determine whether to latch warning state. General warning and Extended warning can be specified. bit 0 Extended warning 0: unlatched 1: latched bit 1 General warning 0: unlatched 1: latched	C	All	7-3
	30	For manufacturer's use	—	—	2	Permanently set at 0.	—	—	—
	31	Real time auto tuning estimation speed	—	0-3	2	Set up the load characteristics estimation speed with the real time auto tuning being valid.	B	All	5-1-1 5-1-3 5-1-4
	32	Real time auto tuning custom setup	—	-32768-32767	2	Set up details of real time auto tuning customize mode.	B	All	5-1-1 5-1-3 5-1-4
	34	Hybrid vibration suppression gain	0.1/s	0-30000	2	Set up the hybrid vibration suppression gain for full-closed controlling.	B	Full-closed	5-2-13
	35	Hybrid vibration suppression filter	0.01 ms	0-32000	2	Set up the time constant of the hybrid vibration suppression filter for full-closed controlling.	B	Full-closed	5-2-13
36	Dynamic brake operation input setup	-	0-1	2	Set enable or disable dynamic brake (DB) operation input by I/O. 0: Disabled 1: Enabled Note) This function is available only when the main power is turned off.	R	All	6-3-3	
37	Oscillation detecting level	0.1%	0-1000	2	Set up the oscillation detecting level. Upon detection of a torque vibration whose level is higher than this setup value, the oscillation detection alarm will be issued. If set to 0, oscillation detection warning is disabled.	B	All	7-3	

(To be continued)



## Class 6: Special setting

Class	No.	Title	Unit	Range	Size [byte]	Function / Contents	Attribute	Related control mode	Reference
6	38	Alarm mask setup	—	-32768~32767	2	Set up the alarm detection mask. Placing 1 to the corresponding bit position disables detection of the alarm condition.	R	All	7-3
	39	Alarm mask setup2	-	-32768~32767	2		C	All	7-3
	41	1st damping depth	—	0~1000	2	Specifies the damping depth of the 1st damping function.	B	Position, Full-closed	5-2-7
	42	2-stage torque filter time constant	0.01 ms	0~2500	2	Specifies the filter time constant for the torque command. The filter is disabled if the setting value is 0. This setting remains valid irrespective of gain selection state.	B	All	5-2-14
	43	2-stage torque filter attenuation term	—	0~1000	2	Specifies the attenuation term of the 2-stage torque filter.	B	All	5-2-14
	47	Function expansion setup2	—	-32768~32767	2	Set respective functions in unit of bit. bit0 2 degrees of freedom control mode 0:Invalid 1: Valid bit1 For manufacturer's use Permanently set at 0. bit2 Encoder communication error / warning decision setting 0: Standard specification 1: Relaxation specification bit3 Selection of real-time auto-tuning type at 2 degrees of freedom control 0: Standard type 1: Synchronization type bit4-7 Not used Permanently set at 0. bit8 For manufacturer's use Permanently set at 0. bit9-11 Not used Permanently set at 0. bit12-13 For manufacturer's use Permanently set at 0. bit14 Quadrant glitch inhibit function 0: Invalid 1: Valid bit15 Not used Permanently set at 0. * The least significant bit is bit0. * Bit3 can be used only when bit0 is set to 1 For details on the types, see 5-1-3 "Real-time auto tuning (Two-degrees-of-freedom control mode, standard type)" and 5-1-4 "Real-time auto tuning (Two-degrees-of-freedom control mode, sync type)".	R	All	5-2-15 5-2-16 5-2-17 5-2-18
	48	Tuning filter	0.1ms	0~2000	2	Set the time constant for the tuning filter in 2 degrees of freedom control.	B	Position, Velocity, Full-closed	5-2-16 5-2-17 5-2-18
	49	Command / tuning filter damping	—	0~99	2	Set the attenuation term for the command filter and tuning filter in 2 degrees of freedom control. A decimal number indication is used. The first digit sets the command filter and the second digit sets the tuning filter. Target digit 0 to 4: No attenuation term, $\zeta$ (operated as primary filter) 5 to 9: Secondary filter (Attenuation terms will be 1.0, 0.86, 0.71, 0.50, and 0.35 in order.)  Example) To set the command filter to $\zeta=1.0$ and tuning filter 1 to $\zeta=0.71$ , the setting value should be 75 (first digit=5 ( $\zeta=1.0$ ), second digit=7 ( $\zeta=0.71$ )). For the time constant of the command filter, Pr2.22 "Positional command smoothing filter" will be applied.	B	Position, Full-closed	5-2-16 5-2-18

(To be continued)

## Class 6: Special setting

Class	No.	Title	Unit	Range	Size [byte]	Function / Contents	Attribute	Related control mode	Reference
6	50	Viscous friction compensating gain	0.1%/(10000r/min)	0~10000	2	The command velocity is multiplied by this setting value, which becomes a correction amount added to the torque command. The unit is [rated torque 0.1%/(10000 r/min)].	B	Position, Velocity, Full-closed	5-2-16 5-2-17 5-2-18
	51	Wait time for emergency stop	ms	0~10000	2	Set the time to maintain the motor energization after the brake release output (BRK-OFF) is turned OFF in the event of an alarm requiring emergency stop. * Enabled even when Pr6.10 "Function expansion setup" is set to a value other than bit10=1.	B	All	6-3-6
	52	For manufacturer's use	-	-	2	Permanently set at 0.	-	-	-
	53	For manufacturer's use	-	-	2	Permanently set at 0.	-	-	-
	54	For manufacturer's use	-	-	2	Permanently set at 0.	-	-	-
	57	Torque saturation error protection detection time	ms	0~5000	2	Set the torque saturation error protection detection time. If torque saturation continues for the set time or more, Err16.1 "torque saturation error protection" occurs. When 0 is set, the value set for Pr7.16 is enabled.	B	Position, Velocity, Full-closed	6-4
	58	For manufacturer's use	-	-	4	Permanently set at 0.	-	-	-
	59	For manufacturer's use	-	-	2	Permanently set at 0.	-	-	-
	60	2nd damping depth	-	0~1000	2	Set the damping depth for the 2nd damping function.	B	Position, Full-closed	5-2-7
	61	1st resonance frequency	0.1Hz	0~3000	2	Set the resonance frequency of the load for the 1st model type damping filter.	B	Position	5-2-8
	62	1st resonance attenuation ratio	-	0~1000	2	Set the resonance attenuation ratio of the load for the 1st model type damping filter.	B	Position	5-2-8
	63	1st anti-resonance frequency	0.1Hz	0~3000	2	Set the anti-resonance frequency of the load for the 1st model type damping filter.	B	Position	5-2-8
	64	1st anti-resonance attenuation ratio	-	0~1000	2	Set the anti-resonance attenuation ratio of the load for the 1st model type damping filter.	B	Position	5-2-8
	65	1st response frequency	0.1Hz	0~3000	2	Set the response frequency of the load for the 1st model type damping filter.	B	Position	5-2-8
	66	2nd resonance frequency	0.1Hz	0~3000	2	Set the resonance frequency of the load for the 2nd model type damping filter.	B	Position	5-2-8
	67	2nd resonance attenuation ratio	-	0~1000	2	Set the resonance attenuation ratio of the load for the 2nd model type damping filter.	B	Position	5-2-8
	68	2nd anti-resonance frequency	0.1Hz	0~3000	2	Set the anti-resonance frequency of the load for the 2nd model type damping filter.	B	Position	5-2-8
	69	2nd anti-resonance attenuation ratio	-	0~1000	2	Set the anti-resonance attenuation ratio of the load for the 2nd model type damping filter.	B	Position	5-2-8
	70	2nd response frequency	0.1Hz	0~3000	2	Set the response frequency of the load for the 2nd model type damping filter.	B	Position	5-2-8
	71	3rd damping depth	-	0~1000	2	Set the damping depth for the 3rd damping function.	B	Position, Full-closed	5-2-7
	72	4th damping depth	-	0~1000	2	Set the damping depth for the 4th damping function.	B	Position, Full-closed	5-2-7
	73	Load estimation filter	0.01 ms	0~2500	2	Set the filter time constant for load estimation.	B	Position, Velocity, Full-closed	5-2-10
	74	Torque compensation frequency 1	0.1 Hz	0~5000	2	Set the filter frequency 1 for speed control output.	B	Position, Velocity, Full-closed	5-2-10
	75	Torque compensation frequency 2	0.1 Hz	0~5000	2	Set the filter frequency 2 for speed control output.	B	Position, Velocity, Full-closed	5-2-10

(To be continued)

## Class 6: Special setting

Class	No.	Title	Unit	Range	Size [byte]	Function / Contents	Attribute	Related control mode	Reference
6	76	Load estimation count	—	0-8	2	Set the number of times regarding load estimation.	B	Position, Velocity, Full-closed	5-2-10
	85	Retracting operation condition setting	-	-32768-32767	2	Select retracting operation activation and stop determination conditions.	C	All	6-9
	86	Retracting operation alarm setting	-	0-7	2	Set retracting operation alarm clear attributes.	C	All	6-9
	87	For manufacturer's use	-	-	4	Permanently set at 0.	-	-	-
	88	Absolute encoder multi-turn data upper-limit value	-	0-65534	4	Set the upper-limit value for absolute encoder multi-turn data when Pr0.15 is set to 4. If multi-turn data exceeds the set value, the multi-turn data changes to 0 instead of the set value. When the multi-turn data falls below 0, multi-turn data will change to the set value. When set to Pr0.15 = 0 or 2 (absolute mode), the upper limit of the absolute rotation data becomes 65535, regardless of this setting. This setting will become invalid when Pr0.15 is set to 1 or 3.	C	All	6-7
	95	Over-load warning detection level	%	0-114	2	Sets the threshold value for detecting the warning as the overload load factor increases. Sets with the overload load factor. If 0 is set, overload warning detection is performed under conventional conditions (85% of overload protection level). In addition, if other than "Pr6.96 ≤ Pr6.95 < (Overload level)" is set, overload warning detection is performed under conventional conditions (85% of overload level).	A	All	7-3
96	Over-load warning release level	%	0-114	2	Sets the threshold value for releasing the warning when the load factor decreases from the state when the overload warning is occurring. Sets with the overload load factor. If 0 is set, overload warning detection is performed under conventional conditions (85% of overload protection level). In addition, if other than "Pr6.96 ≤ Pr6.95 < (Overload level)" is set, overload warning detection is performed under conventional conditions (85% of overload protection level).	A	All	7-3	

(To be continued)

## Class 6: Special setting

Class	No.	Title	Unit	Range	Size [byte]	Function / Contents	Attribute	Related control mode	Reference
6	97	Function expansion setup 3	-	-2147483648 - 2147483647	4	<p>Set various functions on a bit basis.</p> <p>bit0: Enables/Disables quadrant projection compensation function extended. 0: Disabled, 1: Enabled * To set the compensation amount of quadrant projection by inversion direction when the direction of the velocity has changed, set Pr6.97 bit0 to 1.</p> <p>bit1: Deterioration diagnosis warning function: 0: Disabled, 1: Enabled</p> <p>bit2: Expansion of Allowable motor operating range abnormal protection: 0: Disabled, 1: Enabled</p> <p>bit3: External scale single-turn data monitor selection *1) 0: No reversal (data obtained by scale) 1: Reversed ※ This bit is valid only under full-closed control (rotary scale).</p> <p>bit4-5: For manufacture use. Permanently set at 0.</p> <p>bit6: 6064h (Position actual value) switching with backlash compensation. *1) 0: 6064h = 6063h(Position actual internal value) – Pr7.05 1: 6064h = 6063h(Position actual internal value)</p> <p>bit7: For manufacture use. Permanently set at 0.</p> <p>bit8: Extension of the subject control mode for 607Fh (Max profile velocity). *1) 0: standard specification (pp,hm,ip,pv) 1: expansion specification (pp,hm,ip,pv,tq,cst)</p> <p>bit9-10: For manufacture use Permanently set at 0</p> <p>bit11: External scale position latch during semi-closed control *2) 0: Disabled, 1: Enabled</p> <p>bit12: Velocity limit priority function during torque control *2) 0: Torque command priority 1: Velocity limit priority</p> <p>bit13: Toggle output of the Touch Probe latch completion state *2) 0: Disabled, 1: Enabled</p> <p>bit14: Over-travel inhibition warning *3) 0: Invalid, 1: valid</p> <p>bit15-31: For manufacture use. Permanently set at 0.</p> <p>*bit 0 is the least significant bit.</p>	B	All	4-4-1 4-5-4 5-2-15 6-2 6-8 7-3 Ether CAT

\*1) It is not supported in versions corresponding to function extended edition 2 or earlier.

\*2) It is not supported in versions corresponding to function extended edition 6 or earlier.

\*3) It is not supported in versions corresponding to function extended edition 7 or earlier.

(To be continued)

## Class 6: Special setting

Class	No.	Title	Unit	Range	Size [byte]	Function / Contents	Attribute	Related control mode	Reference
6	98	Function expansion setup 4	-	-2147483648 - 2147483647	4	Sets various function in bit units: bit 0 to2: For manufacture use. Permanently set at 0. bit3 : Effective bit setting of Multi-turn data. *1) 0: 16bit, 1: 9bit bit4-7 : For manufacture use. Permanently set at 0. bit8 : Control mode switching function expansion *1) 0 : Conventional specification 1 : hm operation expansion specification bit9 : For manufacture use. Please set fixed to 0 bit10 : Switching of the specification for external scale absolute position *1) on PANATERM monitor screen 0 : External scale absolute position 1 : External scale single-turn data bit11 to 20 : For manufacture use. Please set fixed to 0 bit21 : Extension of conditions for releasing over-travel inhibition *3) 0 : Conventional specification 1 : Expansion specification bit22-31 : For manufacture use. Please set fixed to 0 *bit 0 is the least significant bit.	R	All	-
	100 *2)	For manufacturer's use	-	-	2	Please set fixed to 4000.	-	-	-
	101 *2)	For manufacturer's use	-	-	2	Please set fixed to 0.	-	-	-
	102 *3)	Setting of over-travel inhibition release level	Command unit	0 ~ 2147483647	4	Sets the absolute value of the position deviation amount to release the over-travel inhibition state. If the position deviation amount is greater than the set value, the over-travel inhibition state will not be released. When Pr5.04 "Over-travel inhibition input setting" ≠ 1, set Pr6.102 to 0.	B	Csp	6-3-1

\*1) It is not supported in versions corresponding to function extended edition 2 or earlier.

\*2) It is not supported in versions corresponding to function extended edition 3 or earlier.

\*3) It is not supported in versions corresponding to function extended edition 5 or earlier.

## 9-1-8 Class 7: Special setting 2

Class	No.	Title	Unit	Range	Size [byte]	Function / Contents	Attribute	Related control mode	Reference
7	00	Display on LED	—	0-32767	2	Select type of data displayed on front panel 7-seg LED. *3)	A	All	3-2
	01	Display time setup upon power-up	100 ms	0-1000	2	Sets node address display time at turning on of control power. *3) When the setting value is 0 to 6, it is processed in 600ms.	R	All	3-2
	03	Output setup during torque limit	—	0-1	2	Set up judgment condition of output while torque is limited by torque control. 0: Turn ON at torque limit including torque command value 1: Turn ON at torque limit excluding torque command value	A	Torque	—
	04	Backlash compensation selection	—	0~7	2	Select the backlash compensation for position control. bit0-1:Enable/disable backlash compensation and select operation direction during correction *1) 00b:Disabled 01b:Correct the backlash at the first operation in the positive direction after the servo is turned on. 10b:Correct the backlash at the first operation in the negative direction after the servo is turned on. 11b:Manufacturer specification bit2:Extension of conditions for holding the backlash compensation state *2) 0:Conventional specification 1:Extended specification	B	Position, full-closed	6-10 Ether CAT
	05	Amount of backlash compensation	pulse	-1073741824 ~1073741823	4	Set the amount of backlash (mechanical gap between the driving shaft and the driven shaft) compensation during position control. (Note) It is not supported in function extended edition 2 and earlier versions.	B	Position, full-closed	Ether CAT
	06	Backlash compensation time constant	0.01ms	0~6400	2	Set the backlash compensation time constant during position control. (Note) It is not supported in function extended edition 2 and earlier versions.	B	Position, full-closed	Ether CAT
	07	For manufacturer's use	—	—	2	Permanently set at 0.	—	—	—
	08	For manufacturer's use	—	—	2	Permanently set at 0.	—	—	—
	09	Correction time of latch delay 1	25ns	-2000-2000	2	Set the correction time for delay of the latch trigger signal detection. This parameter can be switched by Pr7.24 bit5. bit5 is 0: The correction time is reflected in both the latch signal rising edge detection and the latch signal falling edge detection. bit5 is 1: The correction time is reflected in the latch signal rising edge detection. *Signal state of edge detection means the following The rising edge detection means the photocoupler is turned ON. The falling edge detection means the photocoupler is turned OFF.	B	All	EtherCAT Spec.
	10	For manufacturer's use	—	—	2	Permanently set at 3.	—	—	—
	11	For manufacturer's use	—	—	4	Permanently set at 0.	—	—	—
	12	For manufacturer's use	—	—	4	Permanently set at 0.	—	—	—
	13	For manufacturer's use	—	—	4	Permanently set at 0.	—	—	—

\*1) It is not supported in software versions prior to enhanced version 2.

\*2) It is not supported in software versions prior to enhanced version 7.

\*3) Please do not change the shipment value setting with V frame.

(To be continued)

Class 7: Special setting 2									
Class	No.	Title	Unit	Range	Size [byte]	Function / Contents	Attribute	Related control mode	Reference
7	14	Main power off warning detection time	ms	0-2000	2	When a main power supply interception state continues, time until it detects main power supply OFF warning is set up. *2) 0-9, 2000: Warning detection is disabled. 10-1999: Unit is [1 ms] Note: Set this parameter so that Pr.7.14 becomes smaller than Pr.5.09 in order for the warning detection is performed before shut-down detection. If the voltage between P and N of the main power converter is decreased to below a specified value before the warning is detected because the setting value is long, the main power low voltage error (Err13.0) occurs before the warning.	C	All	7-3
	15	For manufacturer's use	—	—	4	Permanently set at 0.	—	—	—
	16	Torque saturation error protection frequency	time	0-30000	2	If torque saturated is continued during a preset frequency, Err 16.1 "Torque saturation protection" will be activated. The number of times is counted up every 0.25 ms. For example, when 30000 is set, Err16.1 occurs if the torque saturation condition continues for 7.5 seconds. The count is cleared when the torque saturation condition is removed. When the value set for Pr6.57 is other than 0, the value set for Pr6.57 is enabled.	B	Position, Velocity Full-closed	6-4
	18 *1)	Backlash compensation value holding range	Command position	0~ 2147483647	4	Set the dead zone for backlash compensation when the servo status changes from OFF to ON. If 0 is specified for this setting, the function will be disabled. This parameter does not depend on the Pr7.04 bit2 setting. *1)	B	Position, Full-closed	—
	22	Communication function extended setup 1	—	-32768 -32767	2	bit 0-3: For manufacturer's use All bits permanently set at 0. bit 4: External scale position information monitoring function under semi-closed control setting: 0 : Invalid 1 : Valid * Under full-closed control, external scale position information can be monitored regardless of the setting of this bit. bit 5: 6080h(Max motor speed) on csp mode (Amount of change saturation function of command position) 0: Invalid on csp 1: Valid on csp bit 6: Homing return speed limit function enabled 0: Invalid 1: Valid bit 7: In Z phase homing Over-travel inhibit input setup 0: Invalid 1: Valid bit 8-10: For manufacturer's use All bits permanently set at 0. bit 11 : LINK establishment mode selection 0 : mode0 1 : mode1 If link establishing is late, it might be improved by changing the setting. bit 12-15: For manufacturer's use All bits permanently set at 0. *Set up the properly according to the specifications of the host controller. If the setting is not proper, the operation is not be guaranteed.	R	All	4-8

\*1) It is not supported in software versions prior to enhanced version 7.

\*2) Please do not change the shipment value setting with V frame.

(To be continued)

## Class 7: Special setting 2

Class	No.	Title	Unit	Range	Size [byte]	Function / Contents	Attribute	Related control mode	Reference
7	23	Communication function extended setup 2	—	-32768 -32767	2	bit0-13: For manufacturer's use All bits permanently set at 0. bit14 : Command positional deviation [Command unit] output setting 0: Internal command position (after filter) [Command unit] - Actual position [command unit] 1: Internal command position (before filter) [Command unit] - Actual position [Command unit]	B	All	3-4
	24	Communication function extended setup 3	—	-32768 -32767	2	bit 0 : Specifies output status of EX-OUT1 during communication shut-down after EtherCAT communication is established. (*) 0: Hold 1: Initialized (Output when EX-OUT1 is 0.) (*)ESM state is more than PreOP. bit 1-3: For manufacturer's use Permanently set at 0. bit 4 : For manufacturer's use Permanently set at 1. bit 5 : The correction function for detection delay of latch position. 0:The correction time of both the latch signal rising edge detection and the latch signal falling edge detection is set by Pr7.09 1:The correction time of the latch signal rising edge detection is set by Pr7.09, the correction time of the latch signal falling edge detection is set by Pr7.92. bit 6 : For manufacturer's use Permanently set at 0. bit 7 : Internal value state selection of objects 60B2h(Torque offset) in servo-off(Fall prevention function in the event of Servo-ON) 0: Clear 1: Updated with the set value of 60B2h bit 8-10 : For manufacturer's use Permanently set at 0. bit11: The setting condition of 6041h bit12(drive follows command value). 0 : Limiting torque and speed limit (only cst) is included. 1 : Limiting torque and speed limit (only cst) is not included. bit12-13 : For manufacturer's use Permanently set at 1. bit 14-15: For manufacturer's use All bits permanently set at 0.	C	All	2-2 6-3-6 EtherCAT Spec.
	39	For manufacturer's use	—	—	2	Permanently set at 0.	—	—	—
	40	Station alias setting (high)	—	0-255	2	Define the higher 8 bits of station alias.	R	All	EtherCAT Spec.
	41	Station alias selection	—	0-2	2	Select the setting origin of a station alias. 0 : RSW(lower)+Pr7.40(higher) 1 : SII 2 : For manufacturer's use	R	All	EtherCAT Spec.
42	Maximum continuation communication error	—	-32768 - 32767	2	Set up the maximum of times of continuation communication error occurrence. bit0-3 : Err80.7 detection threshold bit4-7 : (Reserved) bit8-11 : (Reserved) bit12-15 : (Reserved)	R	All	EtherCAT Spec.	

(To be continued)



## Class 7: Special setting 2

Class	No.	Title	Unit	Range	Size [byte]	Function / Contents	Attribute	Related control mode	Reference
7	43	Lost link detection time	ms	0-32767	2	An ESM state after Init->PreOP changes, When either Port0 or Port1 carries out this parameter setup time progress in the state (Port which is Lost link removes from an Init->PreOP changes time) where it was set to Lost link, Err85.2 "Lost link detection unusual protection" occurs. When 0 is set up, detection of Err85.2 "Lost link detection unusual protection" is disabled.	R	All	EtherCAT Spec.
	44	Software version	—	-2147483648-2147483647	4	The software versions 1 and 2 of a product are displayed. bit 31-28:Reserved(Permanently set at 0) bit 27-16:Software version 1 (in hexadecimal three-digit notation) bit 15-12:Reserved(Permanently set at 0) bit 11-0:Software version 2 (in hexadecimal three-digit notation) For example, in the case of Software version 1: 1.23 and Software version 2: 4.56, the value of this parameter will be 01230456h (19072086).	X	All	EtherCAT Spec.
	79	For manufacturer's use	—	—	2	Permanently set at 0.	—	—	—
	87	Communication function extended setup 5	—	-32768 – 32767	2	bit 0-9: For manufacturer's use All bits permanently set at 0. bit 10-11: For manufacturer's use All bits permanently set at 1. bit 12: For manufacturer's use All bits permanently set at 0. bit13:The setting condition of 6041h bit12(drive follows command value).*1) 0:POT/NOT signal detection (only csp) is included. 1:POT/NOT signal detection (only csp) is not included. bit 14-15: For manufacturer's use All bits permanently set at 0.	C	All	—
	92	Correction time of latch delay 2	25ns	-2000 – 2000	2	Set the correction time for delay of the latch trigger signal detection. This parameter can be switched by Pr7.24 bit5. bit5 is 0: Invalid bit5 is 1: The correction time is reflected in the latch signal falling edge detection. *Signal state of edge detection means the following The rising edge detection means the photocoupler is turned ON. The falling edge detection means the photocoupler is turned OFF.	B	All	EtherCAT Spec.
	93	Homing return speed limit value	r/min	0 – 20000	2	Sets the Homing return limit speed. When the set value is less than the internal minimum speed, it is limited by the internal minimum speed. When setting value is greater than the maximum motor speed, it will be limited by the maximum motor speed. (Note) The value is converted into [command unit/s] during internal computation. The converted value is limited within the following range. 00000001h to 7FFFFFFFh (1 to 2147483647) If 0 is set for this parameter, 1 is internally set for control.	C	All	EtherCAT Spec.

\*1) It is not supported by the software versions of function extended version 9 or earlier.

(To be continued)

## Class 7: Special setting 2

Class	No.	Title	Unit	Range	Size [byte]	Function / Contents	Attribute	Related control mode	Reference
7	99	Communication function extended setup 6	—	-32768 – 32767	2	bit0: Activation of operation command (test run, FFT, etc.) execution by USB communication (PANATERM) when EtherCAT communication is established: 0: Invalid 1: Valid bit1-2: For manufacturer's use All bits permanently set at 0. bit3: Command pulse accumulation value [command unit] output setting 0: Before filter 1: After filter bit4-15: For manufacturer's use All bits permanently set at 0.	B	All	EtherCAT Spec.
	100	For manufacturer's use	—	—	2	Permanently set at 0.	—	—	—
	101	For manufacturer's use	—	—	4	Permanently set at 0.	—	—	—
	102	For manufacturer's use	—	—	4	Permanently set at 0.	—	—	—
	103	For manufacturer's use	—	—	4	Permanently set at 0.	—	—	—
	104	For manufacturer's use	—	—	4	Permanently set at 0.	—	—	—
	108	For manufacturer's use	—	—	2	Permanently set at 7.	—	—	—
	109	For manufacturer's use	—	—	2	Permanently set at 0.	—	—	—
	110	Communication function extended setup 7	—	-2147483648 ~ 214748364	4	Sets each communication functions by bit unit. bit0-6 For manufacturer's use, Fix at 0. bit7 Err80.7 enhancement *2) 0:Invalid 1:Valid bit8 Err80.3 enhancement *2) 0:Invalid 1:Valid bit9-31 For manufacturer's use, Fix at 0.	B	All	EtherCAT Spec.
	113	Torque offset filter	0.01ms	0~6400	2	Set up the time constant of the 1st delay filter for torque offset. (Note) It is not supported in function extended edition 2 and earlier versions.	B	All	—
	120 *1)	Absolute Scale Offset 1	rotation/pulse (Upper 32 bits of external scale)	-2147483648 ~ 2147483647	4	When performing homing in the absolute mode, the amplifier automatically set the difference (offset value) between the 0 position of the encoder (or 0 position of the external scale) and the home position detection position so that 6063h of the home position becomes 0. *2) It is equivalent to the upper 32 bit of the encoder multiple rotation data or the data of 64 bit (consists of upper 24 bit and lower 24 bit data) of the external scale. Please do not manually set up this parameter because home position changes when the value of this object changes. *3) This parameter is invalid in the incremental mode (Pr.0.15 = 1).	R	All	—

\*1) It is not supported by the software versions of function extended version 3 or earlier.

\*2) It is not supported by the software versions of function extended version 9 or earlier.

(To be continued)

## Class 7: Special setting 2

Class	No.	Title	Unit	Range	Size [byte]	Function / Contents	Attribute	Related control mode	Reference
7	121 *1)	Absolute Scale Offset 2	pulse/ pulse (Lower 32 bits of external scale)	-2147483648 ~ 2147483647	4	When performing homing in the absolute mode, the amplifier automatically set the difference (offset value) between the 0 position of the encoder (or 0 position of the external scale) and the home position detection position so that 6063h of the home position becomes 0. *2) It is equivalent to the upper 32 bit of the data of a single rotation of the encoder or the data of 64 bit (consists of upper 24 bit and lower 24 bit data) of the external scale. Please do not manually set up this parameter because home position changes when the value of this object changes. *3) This parameter is invalid in the incremental mode (Pr.0.15 = 1).	R	All	—

\*1) It is not supported by the software versions of function extended version 3 or earlier.

\*2) After the setting, only this parameter is automatically saved in the EEPROM.

\*3) Please manually set 0 to this object and write to EEPROM when you want to return the home position to the initial state.

Change both objects Pr.7.120 and Pr.7.121 to 0.

When any value other than 0 is manually set, machine behaviors will not be guaranteed.

Manually set values will be valid when the control power is turned on again.

## 9-1-9 Class 8: Special setting 3

Class	No.	Title	Unit	Range	Size [byte]	Function / Contents	Attribute	Related control mode	Reference
8	00	For manufacturer's use	—	—	2	Permanently set at 0.	—	—	—
	01	Profile linear acceleration constant	10000 command unit/s <sup>2</sup>	1-429496	4	Set the acceleration of retracting operations. Make sure that this is set before retracting operation activation.	B	All	6-9
	02	For manufacturer's use	—	—	2	Permanently set at 0.	—	—	—
	03	For manufacturer's use	—	—	2	Permanently set at 0.	—	—	—
	04	Profile linear deceleration constant	10000 command unit/s <sup>2</sup>	1-429496	4	Set the deceleration of retracting operations. Make sure that this is set before retracting operation activation.	B	All	6-9
	05	For manufacturer's use	—	—	2	Permanently set at 0.	—	—	—
	10	For manufacturer's use	—	—	4	Permanently set at 0.	—	—	—
	12	For manufacturer's use	—	—	2	Permanently set at 0.	—	—	—
	13	For manufacturer's use	—	—	4	Permanently set at 0.	—	—	—
	14	For manufacturer's use	—	—	4	Permanently set at 0.	—	—	—
	15	For manufacturer's use	—	—	4	Permanently set at 0.	—	—	—
	17	Relative movement of retracting operation	Command unit	-2147483647 — 2147483647	4	Set the amount of movement at the time of retracting operation based on the pre-filter command position. If the movement amount is 0 after the processing by the electronic gear, after emergency stop, no retracting operation is performed and Err87.1 or Err87.2 occurs. Make sure that this is set before retracting operation activation. * This is a signed data, and thus caution is required on the direction of retracting operation.	B	All	6-9
	18	Retracting operation speed	Command unit/s	0- 2147483647	4	Set the speed of retracting operations. If 0 is set for this parameter, 1 is set internally. The maximum value is set internally to a smaller value between 6080h (Max motor speed) and the maximum motor speed. Make sure that this is set before retracting operation activation.	B	All	6-9
	19	For manufacturer's use	—	—	2	Permanently set at 0.	—	—	—

## 9-1-10 Class 9: Linear

Class	No.	Title	Unit	Range	Size [byte]	Function / Contents	Attribute	Related Control mode	Reference
9	0	For manufacturer's use	-	-		Permanently set at 0.	-	-	-
9	1	External scale resolution	pulse	0~ 536870912	4	Set the resolution of absolute rotary scale to be connected for full-closed control function (rotary scale). Only the absolute rotary scales of 23bit (8,388,608 resolution), 27bit (134,217,728 resolution), and 29bit (536,870,912 resolution) are supported.	R	Position (csp)	4-5-4
9	2	For manufacturer's use	-	-	2	Permanently set at 0.	-	-	-
9	3	For manufacturer's use	-	-	2	Permanently set at 0.	-	-	-
9	4	For manufacturer's use	-	-	2	Permanently set at 0.	-	-	-
9	5	For manufacturer's use	-	-	2	Permanently set at 0.	-	-	-
9	6	For manufacturer's use	-	-	2	Permanently set at 0.	-	-	-
9	7	For manufacturer's use	-	-	2	Permanently set at 0.	-	-	-
9	8	For manufacturer's use	-	-	2	Permanently set at 0.	-	-	-
9	9	For manufacturer's use	-	-	2	Permanently set at 0.	-	-	-
9	10	For manufacturer's use	-	-	2	Permanently set at 0.	-	-	-
9	11	For manufacturer's use	-	-	2	Permanently set at 1.	-	-	-
9	12	For manufacturer's use	-	-	2	Permanently set at 80.	-	-	-
9	13	For manufacturer's use	-	-	2	Permanently set at 50.	-	-	-
9	14	For manufacturer's use	-	-	2	Permanently set at 10.	-	-	-
9	17	For manufacturer's use	-	-	2	Permanently set at 0.	-	-	-
9	18	For manufacturer's use	-	-	2	Permanently set at 0.	-	-	-
9	19	For manufacturer's use	-	-	2	Permanently set at 0.	-	-	-
9	20	For manufacturer's use	-	-	2	Permanently set at 0.	-	-	-
9	21	For manufacturer's use	-	-	2	Permanently set at 0.	-	-	-
9	22	For manufacturer's use	-	-	2	Permanently set at 200.	-	-	-
9	23	For manufacturer's use	-	-	2	Permanently set at 50.	-	-	-
9	24	For manufacturer's use	-	-	2	Permanently set at 100.	-	-	-
9	25	For manufacturer's use	-	-	2	Permanently set at 40.	-	-	-
9	26	For manufacturer's use	-	-	2	Permanently set at 40.	-	-	-
9	27	For manufacturer's use	-	-	2	Permanently set at 1000.	-	-	-
9	28	For manufacturer's use	-	-	2	Permanently set at 100.	-	-	-
9	29	For manufacturer's use	-	-	2	Permanently set at 0.	-	-	-
9	30	For manufacturer's use	-	-	4	Permanently set at 0.	-	-	-
9	31	For manufacturer's use	-	-	2	Permanently set at 0.	-	-	-
9	32	For manufacturer's use	-	-	2	Permanently set at 0.	-	-	-
9	33	For manufacturer's use	-	-	2	Permanently set at 100.	-	-	-
9	34	For manufacturer's use	-	-	2	Permanently set at 0.	-	-	-
9	48	For manufacturer's use	-	-	2	Permanently set at 0.	-	-	-
9	49	For manufacturer's use	-	-	2	Permanently set at 0.	-	-	-
9	50	For manufacturer's use	-	-	2	Permanently set at 0.	-	-	-

## 9-1-11 Class 15: For manufacturer's use

Class	No.	Title	Unit	Range	Size [byte]	Function / Contents	Attribute	Related control mode	Reference
15	00	For manufacturer's use	-	-	2	Permanently set at 0.	-	-	-
	02	For manufacturer's use	-	-	2	Permanently set at 0.	-	-	-
	16	For manufacturer's use	-	-	2	Permanently set at 2.	-	-	-
	17	For manufacturer's use	-	-	2	Permanently set at 4.	-	-	-
	30	For manufacturer's use	-	-	2	Permanently set at 0.	-	-	-
	31	For manufacturer's use	-	-	2	Permanently set at 5.	-	-	-
	33	For manufacturer's use	-	-	2	Permanently set at 0.	-	-	-
	34	For manufacturer's use	-	-	2	Permanently set at 0.	-	-	-
	35	For manufacturer's use	-	-	2	Permanently set at 1.	-	-	-

Note) Class 15 cannot be referred to in EtherCAT communication.

## 9-2 Timing Chart

## 9-2-1 Servo-on signal accept timing on power-up

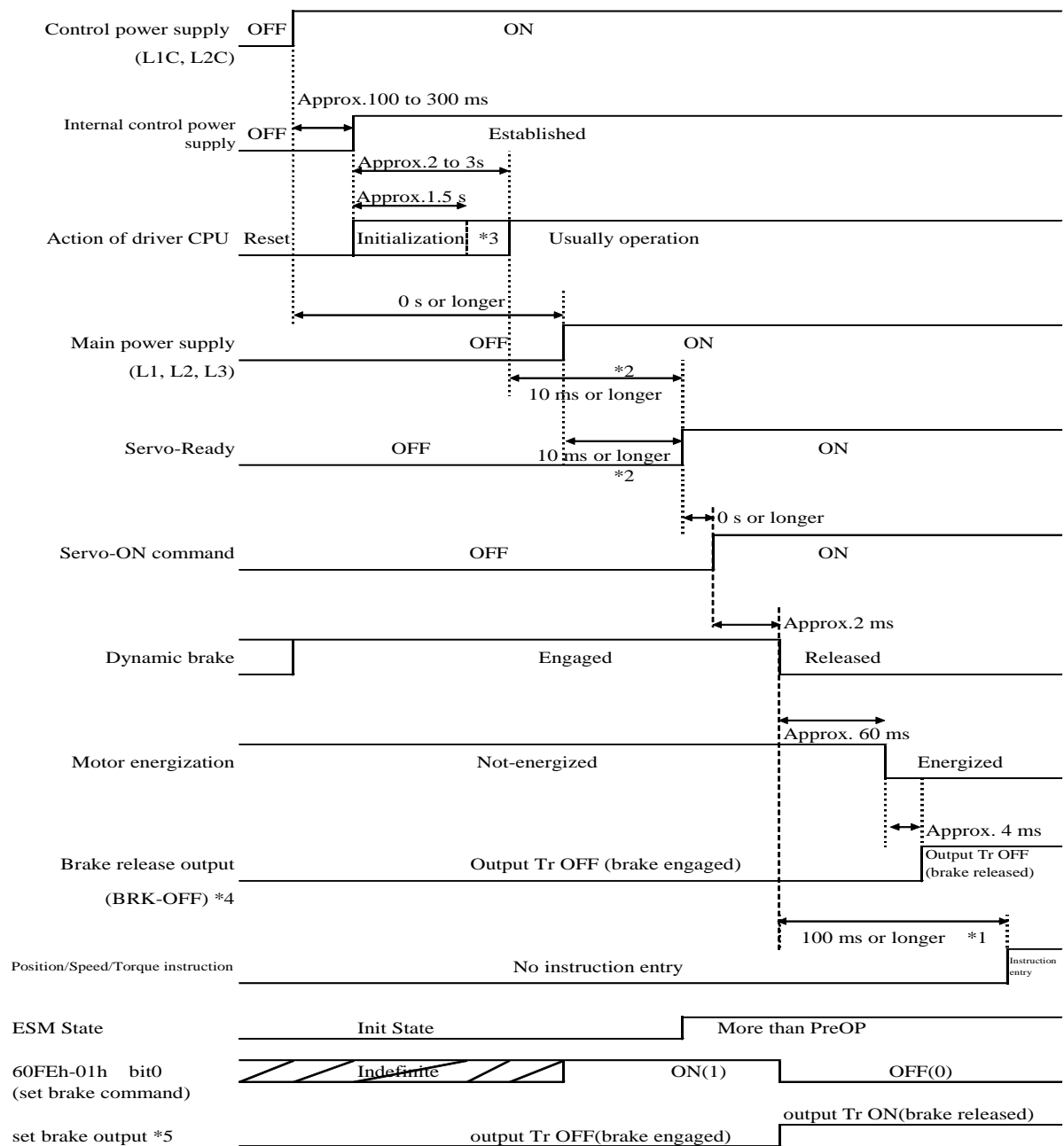

- The above chart shows the timing from AC power-ON to command input.
- Input the servo-On command, position/velocity/torque commands according to the above timing chart.

- \*1. It is shown that an instruction input receptionist is not ready in this section. Please input instructions after the completion of preparation.
- \*2. The servo ready is turned on when all the following conditions are satisfied: "Initialization of microcomputer is completed", "Main power supply is established", "No alarm is issued", and "EtherCAT communication is established".
- \*3. After Internal control power supply, protective functions are active from approx. 1.5 sec after the start of initializing microcomputer. Please set the signals, especially for protective function, for example over-travel inhibit input (POT, NOT) or external scale input, so as to decide their logic until this term. The lapse time can be changed with Pr 6.18 Power-up wait time.
- \*4. A brake release output (BRK-OFF) is different from the set brake of 60FEh via EtherCAT communication.
- \*5. The set brake output is output controlled by the set brake of 60FEh via EtherCAT communication. For information on the set brake output details, refer to the section 6-9-3 in the Technical Reference EtherCAT Communication Specification (SX-DSV03242). The set brake output can be released in the servo-off state. Therefore, please control the set brake output in consideration of safety.

## 9-2-2 Servo-ON/OFF action while the motor is at stall (servo-lock)

(To turn on/off the servo during normal operation, first stop the motor.)

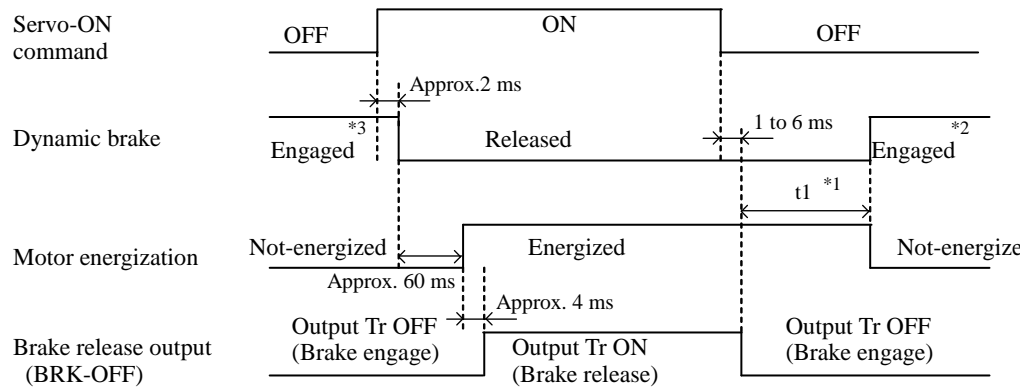

- \*1.  $t_1$  depends on the setup value of Pr 4.37 (Mechanical brake action at stalling setup).
- \*2. The operation of dynamic brake during servo off depends on the setup value of Pr 5.06 (Sequence at Servo-Off).
- \*3. Servo-ON will not be activated until the motor speed falls below approx. 30 r/min.
- \*4. A brake release output (BRK-OFF) is different from the set brake of 60FEh via EtherCAT communication. For information on the set brake output details, refer to the section 6-9-3 in the Technical Reference EtherCAT Communication Specification (SX-DSV03242).



## 9-2-3 Servo-ON/OFF action while the motor is in motion

(Timing at emergency stop or trip. Do not repeat this sequence.)

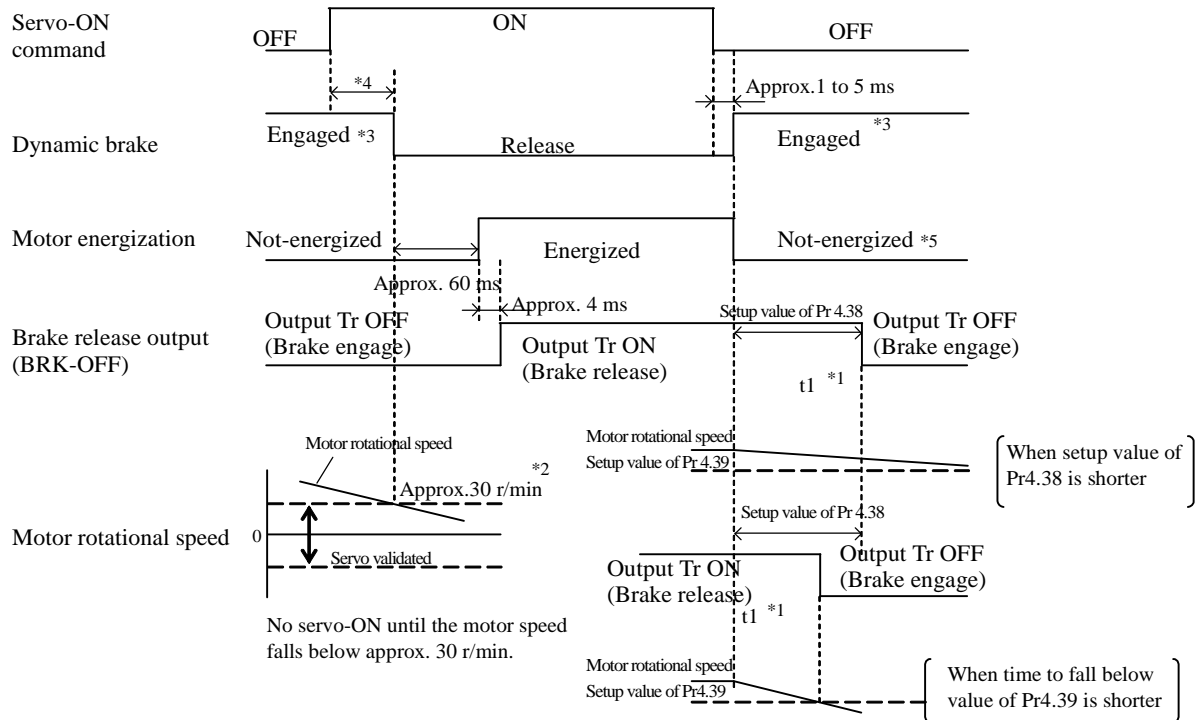

- \*1.  $t1$  will be a shorter time of either the setup value of Pr 4.38 (Mechanical brake action at running setup) or elapsing time for the motor speed to fall below Pr 4.39 (Brake release speed setup).
- \*2. Even when the servo-ON command is turned on again while the motor is decelerating, transition to servo-ON is not performed until the motor stops.
- \*3. For the action of dynamic brake at servo-OFF, refer to an explanation of Pr 5.06 (Sequence at Servo-Off) as well.
- \*4. Servo-ON will not be activated until the motor speed falls below approx. 30 r/min.
- \*5. For the motor energization during deceleration at Servo-OFF depends on the setup value of Pr 5.06 (Sequence at Servo-Off).
- \*6. A brake release output (BRK-OFF) is different from the set brake of 60FEh via EtherCAT communication. For information on the set brake output details, refer to the section 6-9-3 in the Technical Reference EtherCAT Communication Specification (SX-DSV03242).

## 9-2-4 When an error (alarm) has occurred (at Servo-ON command) (DB/Free run deceleration movement)

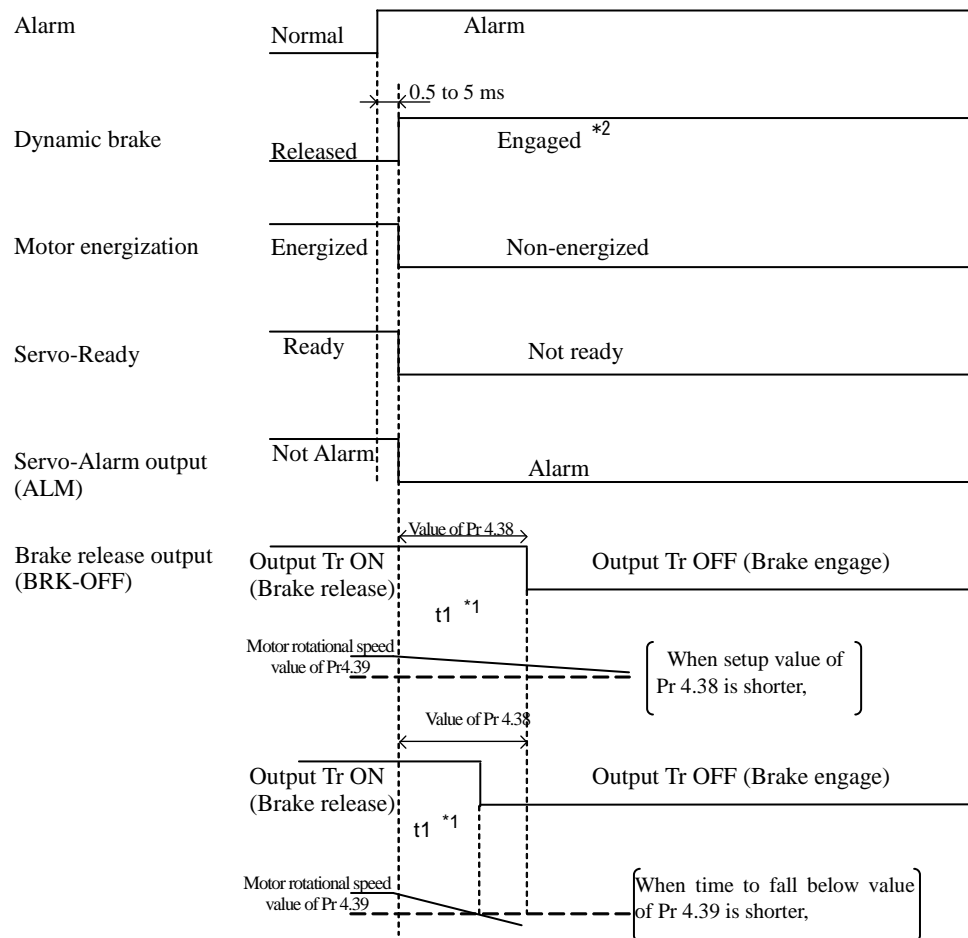

• Timing of the figure above changes in the setting of various sequence operation.

- \*1.  $t_1$  will be a shorter time of either the setup value of Pr 4.38 (Mechanical brake action at running setup) or elapsing time for the motor speed to fall below Pr 4.39 (Brake release speed setup).
- \*2. When an alarm is generated, the dynamic brake operates according to Pr 5.10 (Sequence at alarm).
- \*3. A brake release output (BRK-OFF) is different from the set brake of 60FEh via EtherCAT communication. For information on the set brake output details, refer to the section 6-9-3 in the Technical Reference EtherCAT Communication Specification (SX-DSV03242).

## 9-2-5 When an error (alarm) has occurred (at Servo-ON command) (Emergency stop movement)

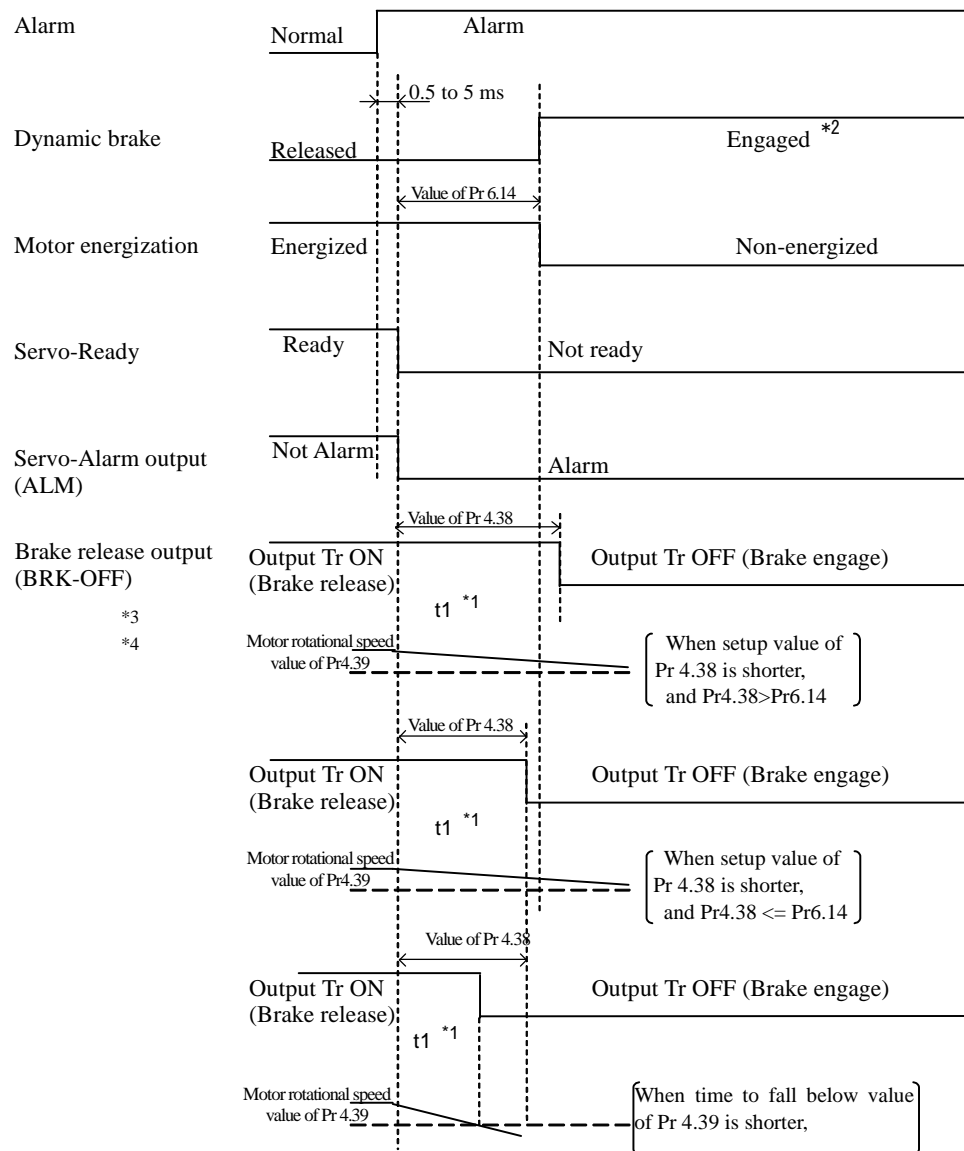

• For the operation timing when the Slow Stop function is valid, refer to section 6-3-7.

• Timing of the figure above changes in the setting of various sequence operation.

- \*1.  $t1$  will be a shorter time of either the setup value of Pr 4.38 (Mechanical brake action at running setup) or elapsing time for the motor speed to fall below Pr 4.39 (Brake release speed setup).
- \*2. When an alarm is generated, the dynamic brake operates according to Pr 5.10 (Sequence at alarm).
- \*3. A brake release output (BRK-OFF) is different from the set brake of 60FEh via EtherCAT communication. For information on the set brake output details, refer to the section 6-9-3 in the Technical Reference EtherCAT Communication Specification (SX-DSV03242).
- \*4. We recommend the setting in which Pr4.38 (Mechanical brake action at running setup) becomes equal to Pr6.14 (Emergency stop time at alarm).  
If Pr4.38 is set to less than or equal to Pr6.14, the brake operates after the length of time set for Pr4.38 elapses.  
If Pr4.38 is set to greater than Pr6.14, the brake does not operate after the length of time set for Pr4.38 elapses, but the brake operates at the time of transition to non-energizing.

## 9-2-6 When an alarm has been cleared (at Servo-ON command)

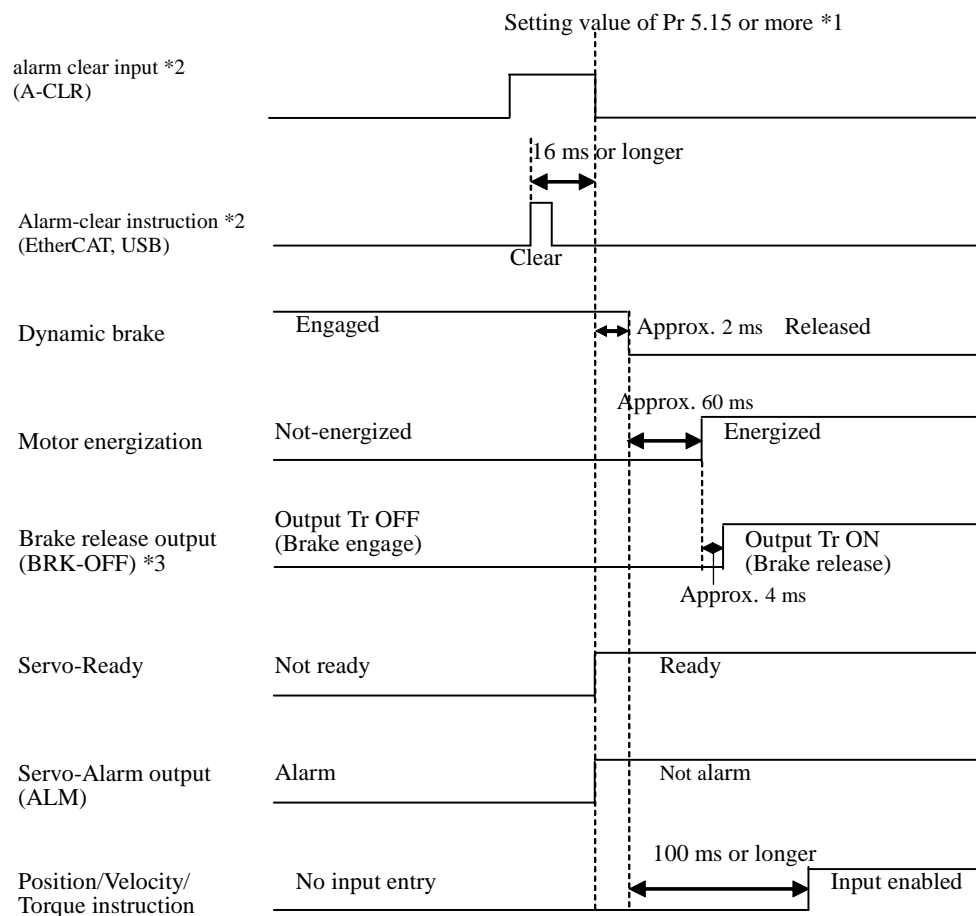

\*1. The length of time for identifying alarm clear input is the length of time set for Pr5.15.

\*2. When clearing an alarm from EtherCAT communication or USB communication(PANATERM), turn OFF alarm clear input (A-CLR) once.

\*3. A brake release output (BRK-OFF) is different from the set brake of 60FEh via EtherCAT communication. For information on the set brake output details, refer to the section 6-9-3 in the Technical Reference EtherCAT Communication Specification (SX-DSV03242).