

PFE Digital Soft Starters

M-7G44-F
090930

Installation Instructions
Montageanweisung
Notice d'installation
Istruzioni per il montaggio
Instrucciones de montaje

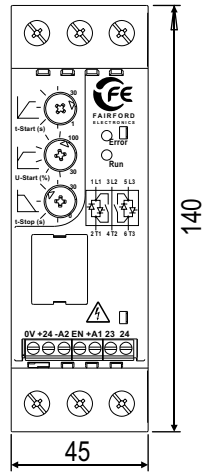
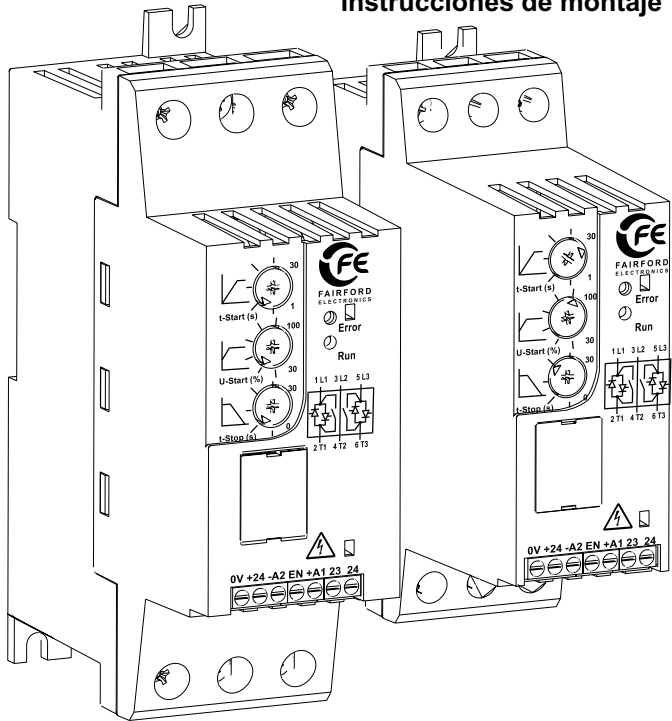

Mounting Centres 30mm x 130mm

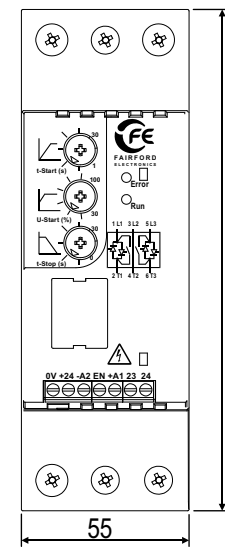
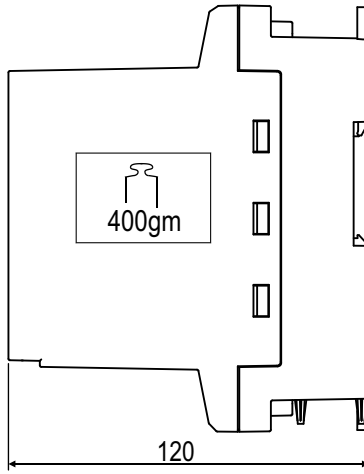

Mounting Centres 40mm x 155mm

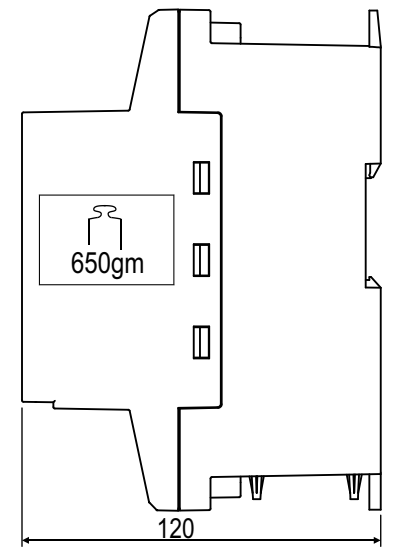

This device is suitable for use in industrial environments. EN 55011/22 Class A
Das Gerät ist für den industriellen Einsatz geeignet EN 55011/22 Klasse A.
L'appareil a été conçu pour l'emploi en milieu industriel EN 55011/22 classe A.
L'apparecchio è adatto per uso in ambienti industriali EN 55011/22 Classe A.
El aparato es adecuado para uso en ambiente industrial EN 55011/22 clase A.

Size1 5Amp to 16Amp
PFE-02 2.2kW @ 400V 5Amp
PFE-04 3kW @ 400V 7Amp
PFE-06 4kW @ 400V 9Amp
PFE-08 5.5kW @ 400V 12Amp
PFE-10 7.5kW @ 400V 16Amp

Size2 22Amp to 41Amp
PFE-12 11kW @ 400V 22Amp
PFE-14 15kW @ 400V 30Amp
PFE-16 18.5kW @ 400V 36Amp
PFE-18 22kW @ 400V 41 Amp (Non UL)
PFE-18 30HP @460V FLA 40A (UL)

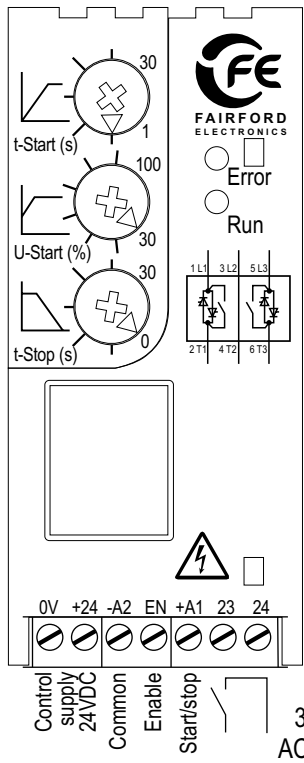

Not Enabled LED green+red - LED grün+rot - DEL vert+rouge - LED verde+rosso - LED verde+rojo
Initialisation - Initialisierung - Initialisation - Inizializzazione - Inicialización

Run LED green - LED grün - DEL vert - LED verde - LED verde
Ready for operation - Betriebsbereit
- Prêt à fonctionner - Pronto al funzionamento
- En condiciones para funcionamiento

Slow Flash Starting - in Rampe - en rampe - in rampa - en rampa

Quick Flash Full volts - vollen Spannung - pleine tension - piena tensione - plena tensión

Full On Soft-Stop - Soft stop - Arrêt progressif - Soft-Stop - Paro suave

Very quick green flash:- Starting to trip on over current

Error Fault LED red - Fehler LED rot - DEL erreur rouge - LED errore rosso - LED error rojo

1	SCR or supply	2	Too hot
3	Control supply low volts	4	Bypass relay failure
5	Shearpin (4.4 x l e)	6	Overcurrent

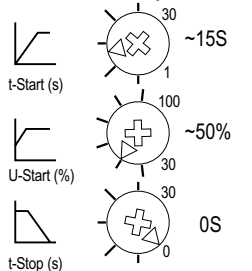
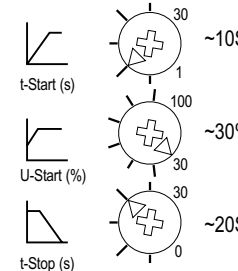
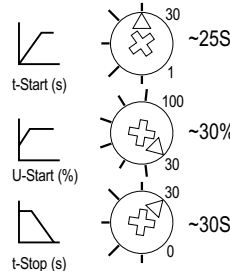
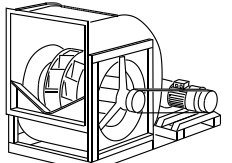
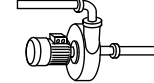
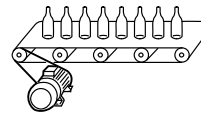
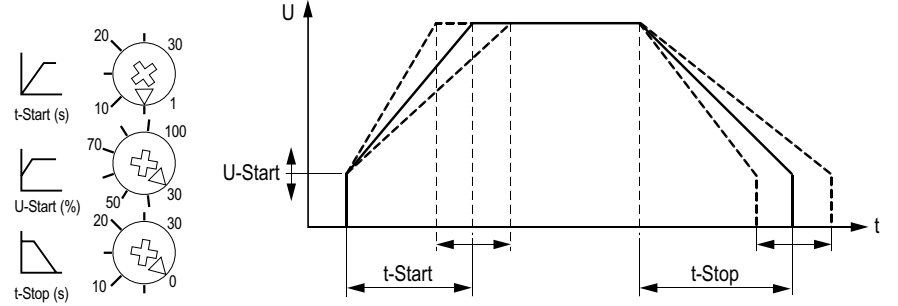

Operation - Betrieb - Service - Funzionamento

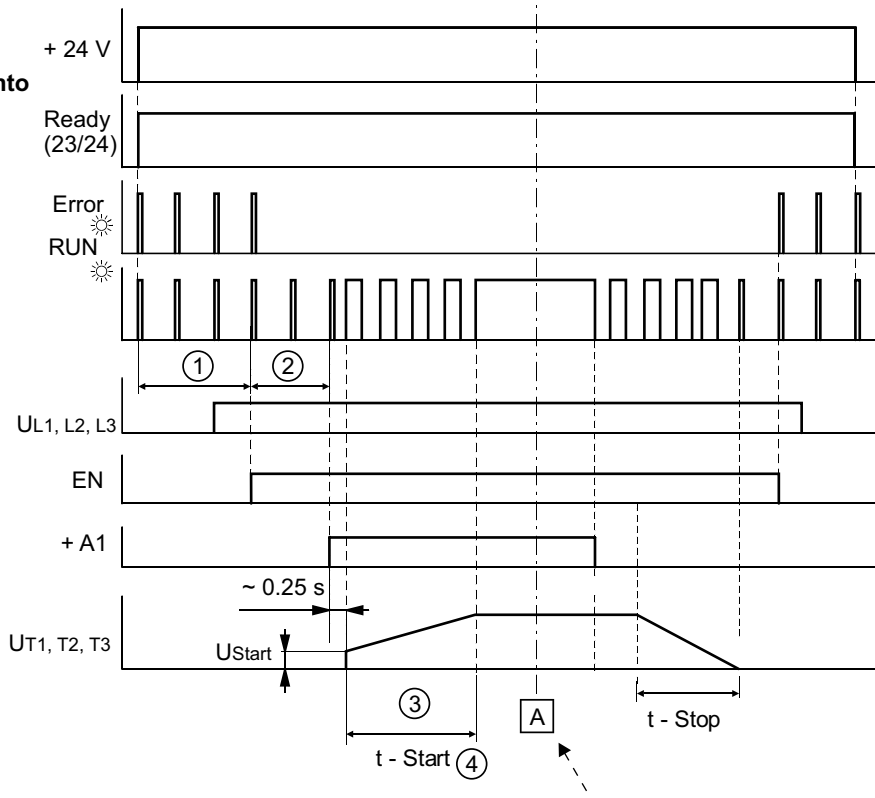

Fault - Störung - Défaut - Guasto - Avería

RUN-LED green - RUN LED grün - DEL RUN verde - LED RUN verde - LED RUN verde - RUN-LED -

Error-LED red - Error LED rot - DEL erreur rouge - LED errore rosso - LED error rojo

- 1 Initialisation - Initialisierung - Initialisation - Inizializzazione - Inicialización
- 2 Ready for operation - Betriebsbereit - Prêt à fonctionner - Pronto al funcionamiento - En condiciones para funcionamiento
- 3 in ramp - in Rampe - en rampe - in rampa - en rampa
- 4 Top of ramp - Rampenende erreicht - Fin de rampe atteinte - Fine rampa - Fin de rampa

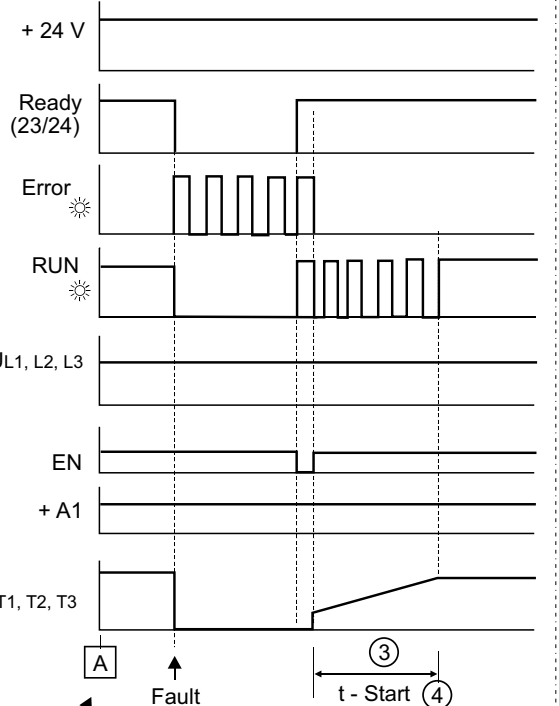

0V, +24
+ A1, E, -A2
23, 24

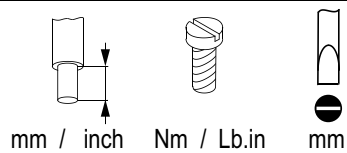

	mm ² / AWG	mm / inch	Nm / Lb.in	mm
1 x	0.5 - 2.5 / 20 - 14	6 / 1/4"	0.4 / 3.5	0.6 x 3.5
2 x	0.5 - 1.5 / 20 - 16			

Melderelais - Signalling relay - Relais à voyant - Relè di segnalazione - Relè de señalización

U	(L)	(R) AC11	I _{min}	U _{min}
250V AC	0.2A	2.5A	10mA	100V AC
30V DC	0.7A	3A	100mA	5V DC



DANGER! Hazardous Voltage. Will cause death or serious injury. Hazardous voltage is also present in the OFF/STOP status of the soft starter when the supply voltage is switched on (Ue).

GEFAHR! Gefährliche Spannung. Lebensgefahr oder schwere Verletzungsgefahr. Bei eingeschalteter Versorgungsspannung (Ue) steht auch im AUS-/STOP-Zustand des Softstarters am Ausgang gefährliche Spannung an.

DANGER! Tension dangereuse. Danger de mort ou risque de blessures graves. En cas de tension d'alimentation (Ue) enclenchée, la tension dangereuse existe aussi en position d'Arrêt à la sortie du démarreur progressif.

PERICOLO! Tensione pericolosa. Può provocare morte o lesioni gravi. Con la tensione di alimentazione (Ue) inserita, anche nello stato OFF/STOP del softstarter è presente tensione pericolosa in uscita.

¡PELIGRO! Tensión peligrosa. Puede causar la muerte o lesiones graves. Si la tensión de alimentación está conectada (Ue), existe también en la salida tensión peligrosa con el arrancador suave en estado OFF/ON.

PFE-02 to PFE-10

1 L1, 3 L2, 5 L3
2 T1, 4 T2, 6 T3

75°C wire
CU only

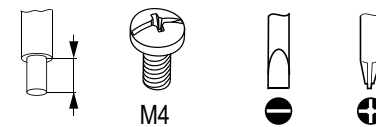

	mm ² / AWG	mm / inch	Nm / Lb.in	mm	
1 or 2 x	1 - 4 / 18 - 12	9 / 3/8"	1.3 / 12	1 x 6	PZ2

PFE-12 to PFE-18

1 L1, 3 L2, 5 L3
2 T1, 4 T2, 6 T3

75°C wire
CU only

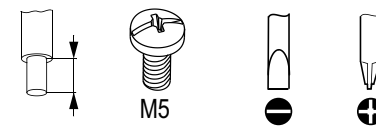

	mm ² / AWG	mm / inch	Nm / Lb.in	mm	
1 or 2 x	2.5 - 10 / 12 - 8	12 / 1/2"	2.5 / 22	1 x 6	PZ2

Where several conductors are to be connected, the difference between the wires/cables used must not exceed one DIN Standard size level.

Bei Mehrleiteranschluss darf maximal ein DIN-Normgrößen-Sprung zwischen den verwendeten Leitern liegen.

En cas de raccordement de plusieurs conducteurs, il faut 1 écartement normalisé max. entre les conducteurs.

In caso di collegamento a più conduttori, è ammesso al massimo un salto di grandezza DIN standard fra i conduttori utilizzati.

En caso de conexión de múltiples conductores puede haber como máximo un salto de magnitud normalizada DIN entre los conductores utilizados.

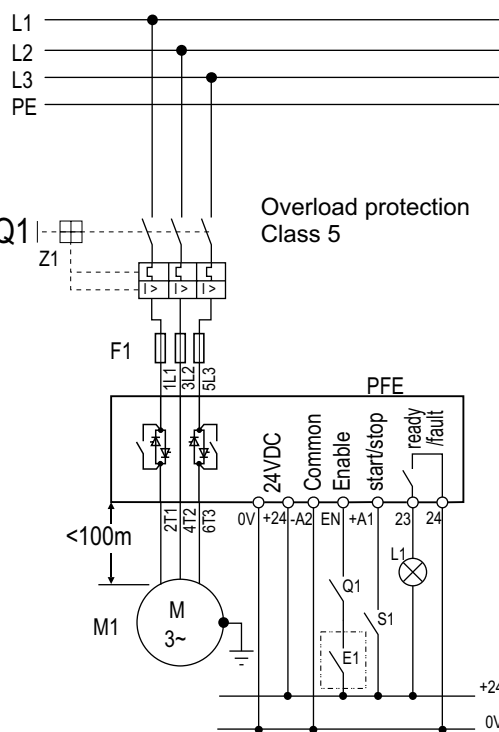

F1 = Coordination Type1
Recommended Semiconductor Fuses
PFE-02 to PFE-08 SIBA 2018920-35
PFE-10 SIBA 2018920-40
PFE-12 to PFE-18 SIBA 2018920-125

UL Requirement - Short Circuit rating 5000A,
480Vac when protected by fuses or circuit
breakers, rated as indicated in table below

MODEL #	Class J or T Fuse Rated 600VAC	Circuit Breaker Rated 600VAC
PFE-02	15A	-
PFE-04	15A	-
PFE-06	30A	-
PFE-08	40A	-
PFE-10	50A	-
PFE-12	80A	80A
PFE-14	100A	100A
PFE-16	125A	125A
PFE-18	150A	150A

Control Circuit Elements
E1 = Optional switch to allow trip
reset without opening main breaker Q1
Q1 = Auxiliary contact of main breaker Q1
S1 = Start/Stop control switch
L1 = Indicator:-
On: Ready
Off: Fault

- Q1 = Cable protection - Leitungsschutz - Protezione di linea - Protección de cable - Protection de câbles
- Z1 = Overload relay - Überlastrelais - Relè termico - Relè de sobrecarga - Relais thermique
- F1 = Semiconductor fuse for type 1 coordination, in addition to Q1
Halbleitersicherung für Zuordnungsart 1, zusätzlich zu Q1
Per avere la protezione del semiconduttore in coordinamento di tipo 1, è necessario un fusibile in aggiunta a Q1
Fusible semiconductor para tipo de coordinación 1, adicionalmente a Q1
Fusible pour semi-conducteurs pour coordination de type 1, additionnel à Q1
- PFE = Soft Starter - Halbleiterschütz - Contactor semiconductor - Contattore a semiconduttori - Contacteur à semi-conducteurs
- A1-A2 = Start/Stop - Start/Stopp - Start/Stop - Arranque/Parada - Démarrage/Arrêt



Electric shock risk. Danger

Only skilled or instructed persons may carry out the following operations.

Lebensgefahr durch elektrischen Strom!

Nur Elektrofachkräfte und elektrotechnisch unterwiesene Personen dürfen die im Folgenden beschriebenen Arbeiten ausführen.

Tension électrique dangereuse !

Seules les personnes qualifiées et averties doivent exécuter les travaux ci-après.

Tensione elettrica: Pericolo di morte!

Solo persone abilitate e qualificate possono eseguire le operazioni di seguito riportate.

¡Corriente eléctrica! ¡Peligro de muerte!

El trabajo a continuación descrito debe ser realizado por personas cualificadas y advertidas.

Rated Impulse withstand Voltage (Uimp) 2.5kV

Rated Insulation Voltage (Ui) 500V

Pollution Degree 2

Rated Short Circuit Current (Iq)* 5kA

Short Circuit Co-ordination* Type 1

Surrounding Air Temperature 0°C to 40°C.

Above 40°C de-rate linearly by 2% of unit FLC per °C to a derate of 40% at 60°C (not UL)

Transport and Storage -25°C to +60°C

Altitude 1000m. 1000-2000m de-rate 1% of unit FLC per 100m to 2000m.

Humidity max. 85% non-condensing, not exceeding 50% at 40°C

IP Rating IP20

Design Standards IEC 60947-4-2; EN60947-4-2

AC Semiconductor Motor Controllers and Starters

United States Standard UL508

* When protected by recommended semiconductor fuse.

Operational Voltage (Ue)

230-460 VAC rms 3-Phase (-15% +10%)

Rated Frequency

50 - 60Hz +/- 2Hz **Form Designation** Form 1

Index Rating

Standard (Class5) AC53b: 3-5: 355

Overcurrent = > 3 x Ie for 5 Seconds

Control Supply Us

24V DC approx 4VA supplied to terminals 0V - +24V

Enable Control

24V DC galvanically isolated terminals -A2 - EN

Start/Stop Control

24V DC galvanically isolated terminals -A2 - +A1

Auxiliary Circuits relay

Ready/Fault - 23/24. 250VAC 2.5A, AC11.

Indication

Red = Error - Green = Run LEDs

t-Start

1 to 30 seconds.

U-Start

30% - 100%

t-Stop

0 to 30 seconds

Start Duty

3 x FLC for 5 seconds at standard rating

Starts / Hour

standard 10 starts per hour or 5 starts + 5 soft stops per hour

with optional fan 60 starts per hour or 30 starts + 30 soft stops per hour

Internally bypassed

Power Terminals

IP20 Rated wire clamping terminals

Listed Soft starter can be used when fitted with fan part numbers as detailed in document M-7G71-F

FAIRFORD ELECTRONICS LIMITED

Bristow House, Gillard Way, Lee Mill Industrial Estate, Ivybridge, Devon, PL21 9GG, England.

FD7G4413 110404
M-7G44-F

Contact us on
Tel: +44 (0)1752 894554
Fax: +44 (0)1752 897145
E-mail: sales@fairford.co.uk
web: www.fairford.co.uk



EMC EMISSION AND IMMUNITY LEVELS		
ESD immunity	IEC 61000-4-2	4kV contact. 8kV air discharge
R F immunity	IEC 61000-4-6	140dBuV over 0.15-80MHz
R F immunity	EC 61000-4-3	10V/m over 80 -1000MHz
Fast Transient immunity	IEC 61000-4-4	2kV/5kHz
Surge immunity	IEC 61000-4-5	2kV line to ground 1kV line to line
Conducted RF emissions	EN 55011	Class A
Radiated RF emissions	EN 55011	Class A